



**İSIDAR**®  
LIGHTING SYSTEM

Fiyat Listesi 2017 / **1**

# kurumsal

İşıldar Aydınlatma Metin BODUR tarafından 1972 yılında İstanbul'da kurulmuştur.

250m<sup>2</sup> kapalı alanda kalıp atölyesini kurarak plastik elektrik malzemeleri imalatına başlamıştır. 2004 yılında değişen görüşleri doğrultusunda; hayat verdiği tasarımları ile aydınlık mekanlar yaratmaya İkitelli Organize Sanayide 6.000 m<sup>2</sup> lik kapalı alana sahip fabrikasında makine parkurunu yenileyerek markalaşmayı da hedef alarak profesyonel Satış ve Pazarlama ekibini kurmuştur. Üretiminin yüzde 50'sini iç pazar, yüzde 50'sini dış pazar oluşturmaktadır.

47 ülkeye ihracatıyla dış pazarda da adını duyuran firmamız, geleceğin global ölçekli firmalarından biri olmayı hedefleyip müşterilerinin aydınlatma firmasından beklediği profesyonel hizmeti, satış ve satış sonrasında da sağlayabilmek için dinamik yapısını hiç bitmeyen enerjisiyle canlı tutmaktadır.

Sektördeki kalıcılığımızı kalite standartlarımızın yükselen grafiği ile müşterilerimizle kurduğumuz karşılıklı güvene dayalı ilişkinin sarsılmaz temeline borçluyuz.

## Neden İŞILDAR?

Müşterilerimizin beklentilerini karşılayan, aydınlatma tekniğinin en güvenilir şekilde hayata geçirildiği, çevre dostu, kaliteli aydınlatma ürünlerini geliştirirken ve üretirken, kalite yönetim sistemimizin sürekli iyileştirilmesini, çalışanların yetkinliklerini arttırıp, katılımcı olmalarını, verimliliği arttırarak rekabetçi kalabilmeyi esas alırız.

## Nasıl Çözeriz?

İşıldar Aydınlatma olarak;

Yükselen başarı grafiğimizi devam ettirerek akla gelen ilk aydınlatma markası olmayı hedefleyerek, enerji tasarrufunu ön planda tutan ürünler üreterek ülke ekonomisine katkı sağlamayı amaçlayarak, müşteri ihtiyaçlarına yönelik kaliteli ürünler üreterek kalitemizi ve güvenilirliğimizi yükselen grafiğimizle birlikte daha da ön plana çıkararak müşterilerimizin ihtiyaçlarına çözüm odaklı yaklaşım politikamızla yürümeye devam edeceğiz.

İŞILDAR  
LIGHTING SYSTEM

# içindekiler

<b>01- Ofis Armatürleri</b>	05/20
<b>02- Eko Serisi Ofis ve Bant Armatürler Ekonomik Modeller</b>	21/32
<b>03- Led'li Ürünler</b>	33/48
<b>04- Bant Tipi Armatürler</b>	49/54
<b>05- Tavan Glop Armatürleri</b>	55/60
<b>06- Duvar Aplikleri</b>	61/64
<b>07- Sensörlü Duvar Armatürleri Sensörlü Duvar Aplikleri</b>	65/68
<b>08- Sarkıt Armatürler</b>	69/70
<b>09- PVC Kablo Kanalları</b>	71/73
<b>10- Panolar-Sigorta Kutuları ve Plastik Elektrik Malzemeleri</b>	74/82



**İŞİDAR**<sup>®</sup>  
LIGHTING SYSTEM

**İŞILDAR**  
LIGHTING SYSTEM



**İŞILDAR**  
LIGHTING SYSTEM

Sıva Altı Ofis Armatürleri  
Sıva Üstü Ofis Armatürleri  
Sıva Altı Dekoratif ve Endüstriyel Armatürler  
CLIP-IN Ofis Armatürleri  
Steril Ortam Armatürleri

**01**

**ALÇIPAN-TAŞYÜNÜ OFİS ARMATÜRLERİ**

## SIVA ALTI ÇİFT PARABOLİK ARMATÜRLER

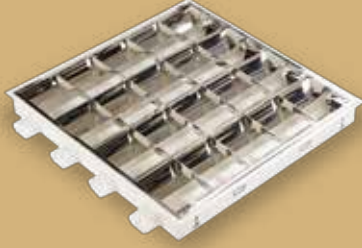

Kod	Cinsi	Ampül	Balast	Amb. Ad.	Koli Ad.	Fiyat (₺)
12 118 002 001 03001	1x18 W	T26	Manyetik	2	10	89.00
12 218 002 001 03002	2x18 W	T26	Manyetik	2	10	91.00
12 418 002 001 03003	4x18 W	T26	Manyetik	2	6	135.00
12 136 002 001 03004	1x36 W	T26	Manyetik	2	4	137.00
12 236 002 001 03005	2x36 W	T26	Manyetik	2	4	149.00
12 436 002 001 03006	4x36 W	T26	Manyetik	2	2	299.00

Gövde : DKP Sac Boya: Elektrostatik toz Duy: Darbe ve ısıya dayanıklı PC. Balast: Bakır Sargılı Starter: General marka  
Reflektör : 5+2 Lamel yüksek saflıkta anodize alüminyum Kablo: Halojen Free, topraklama bağlantılı

## SIVA ALTI PRİZMATİK LENSLİ ARMATÜRLER



Kod	Cinsi	Ampül	Balast	Amb. Ad.	Koli Ad.	Fiyat (₺)
12 118 002 001 03007	1x18 W	T26	Manyetik	2	10	83.00
12 218 002 001 03008	2x18 W	T26	Manyetik	2	10	85.00
12 418 002 001 03009	4x18 W	T26	Manyetik	2	6	127.00
12 136 002 001 03010	1x36 W	T26	Manyetik	2	4	129.00
12 236 002 001 03011	2x36 W	T26	Manyetik	2	4	132.00
12 436 002 001 03012	4x36 W	T26	Manyetik	2	2	342.00

Gövde : DKP Sac Boya: Elektrostatik toz Duy: Darbe ve ısıya dayanıklı PC. Balast: Bakır Sargılı Starter: General marka  
Lens: Akrilik esaslı mor ötesi stabilizatörlü prizmatik Çerçeve: Alüminyum ekstrüzyon Kablo: Halojen Free, topraklama bağlantılı

## SIVA ALTI OPAL LENSLİ ARMATÜRLER



Kod	Cinsi	Ampül	Balast	Amb. Ad.	Koli Ad.	Fiyat (₺)
12 118 002 001 03150	1x18 W	T26	Manyetik	2	10	93.00
12 218 002 001 03151	2x18 W	T26	Manyetik	2	10	95.00
12 418 002 001 03152	4x18 W	T26	Manyetik	2	6	137.00
12 136 002 001 03153	1x36 W	T26	Manyetik	2	4	139.00
12 236 002 001 03154	2x36 W	T26	Manyetik	2	4	142.00
12 436 002 001 03155	4x36 W	T26	Manyetik	2	2	362.00

Gövde : DKP Sac Boya: Elektrostatik toz Duy: Darbe ve ısıya dayanıklı PC. Balast: Bakır Sargılı Starter: General marka  
Lens: Akrilik esaslı mor ötesi stabilizatörlü opal Çerçeve: Alüminyum ekstrüzyon Kablo: Halojen Free, topraklama bağlantılı

## SIVA ALTI LOUVER PETEKLİ ARMATÜRLER

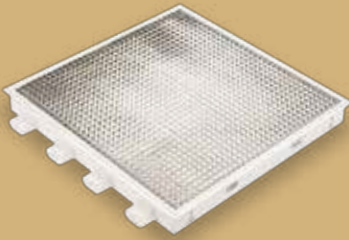

Kod	Cinsi	Ampül	Balast	Amb. Ad.	Koli Ad.	Fiyat (₺)
12 118 002 001 03013	1x18 W	T26	Manyetik	2	10	136.00
12 218 002 001 03014	2x18 W	T26	Manyetik	2	10	138.00
12 418 002 001 03015	4x18 W	T26	Manyetik	2	6	235.00
12 136 002 001 03016	1x36 W	T26	Manyetik	2	4	237.00
12 236 002 001 03017	2x36 W	T26	Manyetik	2	4	239.00
12 436 002 001 03018	4x36 W	T26	Manyetik	2	2	475.00

Gövde : DKP Sac Boya: Elektrostatik toz Duy: Darbe ve ısıya dayanıklı PC. Balast: Bakır Sargılı Starter: General marka  
Lens: Akrilik esaslı parabolik ayna petekli Çerçeve: DKP Sac Kablo: Halojen Free, topraklama bağlantılı

## T8 SIVA ALTI PERFORE KAPAKLI ARMATÜRLER



Kod	Cinsi	Ampül	Balast	Amb. Ad.	Koli Ad.	Fiyat (₺)
12 218 002 001 03162	2x18 W	T26	Manyetik	2	10	147.00
12 418 002 001 03163	4x18 W	T26	Manyetik	2	6	213.00
12 236 002 001 03164	2x36 W	T26	Manyetik	2	4	228.00
12 436 002 001 03165	4x36 W	T26	Manyetik	2	2	415.00

Gövde : DKP Sac Boya: Elektrostatik toz Duy: Darbe ve ısıya dayanıklı PC. Balast: Bakır Sargılı Starter: General marka  
Reflektör : Yüksek saflıkta anodize alüminyum Kablo: Halojen Free, topraklama bağlantılı

## SIVA ÜSTÜ ÇİFT PARABOLİK ARMATÜRLER



Kod	Cinsi	Ampül	Balast	Amb. Ad.	Koli Ad.	Fiyat (₺)
22 118 002 001 03019	1x18 W	T26	Manyetik	2	10	93.00
22 218 002 001 03020	2x18 W	T26	Manyetik	2	10	95.00
22 418 002 001 03021	4x18 W	T26	Manyetik	2	6	139.00
22 136 002 001 03022	1x36 W	T26	Manyetik	2	4	143.00
22 236 002 001 03023	2x36 W	T26	Manyetik	2	4	147.00
22 436 002 001 03024	4x36 W	T26	Manyetik	2	2	307.00

Gövde : DKP Sac Boya: Elektrostatik toz Duy: Darbe ve ısıya dayanıklı PC. Balast: Bakır Sargılı Starter: General marka  
Reflektör : 5+2 Lamel yüksek saflıkta anodize alüminyum Kablo: Halojen Free, topraklama bağlantılı

## SIVA ÜSTÜ PRİZMATİK LENSLİ ARMATÜRLER



Kod	Cinsi	Ampül	Balast	Amb. Ad.	Koli Ad.	Fiyat (₺)
22 118 002 001 03025	1x18 W	T26	Manyetik	2	10	87.00
22 218 002 001 03026	2x18 W	T26	Manyetik	2	10	89.00
22 418 002 001 03027	4x18 W	T26	Manyetik	2	6	131.00
22 136 002 001 03028	1x36 W	T26	Manyetik	2	4	133.00
22 236 002 001 03029	2x36 W	T26	Manyetik	2	4	136.00
22 436 002 001 03030	4x36 W	T26	Manyetik	2	2	349.00

Gövde : DKP Sac Boya: Elektrostatik toz Duy: Darbe ve ısıya dayanıklı PC. Balast: Bakır Sargılı Starter: General marka  
Lens: Akrilik esaslı mor ötesi stabilizatörlü prizmatik Çerçeve: Alüminyum ekstrüzyon Kablo: Halojen Free, topraklama bağlantılı

## SIVA ÜSTÜ OPAL LENSLİ ARMATÜRLER



Kod	Cinsi	Ampül	Balast	Amb. Ad.	Koli Ad.	Fiyat (₺)
22 118 002 001 03156	1x18 W	T26	Manyetik	2	10	97.00
22 218 002 001 03157	2x18 W	T26	Manyetik	2	10	99.00
22 418 002 001 03158	4x18 W	T26	Manyetik	2	6	141.00
22 136 002 001 03159	1x36 W	T26	Manyetik	2	4	143.00
22 236 002 001 03160	2x36 W	T26	Manyetik	2	4	146.00
22 436 002 001 03161	4x36 W	T26	Manyetik	2	2	369.00

Gövde : DKP Sac Boya: Elektrostatik toz Duy: Darbe ve ısıya dayanıklı PC. Balast: Bakır Sargılı Starter: General marka  
Lens: Akrilik esaslı mor ötesi stabilizatörlü opal Çerçeve: Alüminyum ekstrüzyon Kablo: Halojen Free, topraklama bağlantılı

## SIVA ÜSTÜ LOUVER PETEKLİ ARMATÜRLER



Kod	Cinsi	Ampül	Balast	Amb. Ad.	Koli Ad.	Fiyat (₺)
22 118 002 001 03031	1x18 W	T26	Manyetik	2	10	139.00
22 218 002 001 03032	2x18 W	T26	Manyetik	2	10	141.00
22 418 002 001 03033	4x18 W	T26	Manyetik	2	6	239.00
22 136 002 001 03034	1x36 W	T26	Manyetik	2	4	241.00
22 236 002 001 03035	2x36 W	T26	Manyetik	2	4	244.00
22 436 002 001 03036	4x36 W	T26	Manyetik	2	2	495.00

Gövde : DKP Sac Boya: Elektrostatik toz Duy: Darbe ve ısıya dayanıklı PC. Balast: Bakır Sargılı Starter: General marka  
Lens: Akrilik esaslı parabolik ayna petekli Çerçeve: DKP Sac Kablo: Halojen Free, topraklama bağlantılı

## T8 SIVA ÜSTÜ PERFORE KAPAKLI ARMATÜRLER



Kod	Cinsi	Ampül	Balast	Amb. Ad.	Koli Ad.	Fiyat (₺)
22 218 002 001 03166	2x18 W	T26	Manyetik	2	10	151.00
22 418 002 001 03167	4x18 W	T26	Manyetik	2	6	217.00
22 236 002 001 03168	2x36 W	T26	Manyetik	2	4	232.00
22 436 002 001 03169	4x36 W	T26	Manyetik	2	2	419.00

Gövde : DKP Sac Boya: Elektrostatik toz Duy: Darbe ve ısıya dayanıklı PC. Balast: Bakır Sargılı Starter: General marka  
Reflektör : Yüksek saflıkta anodize alüminyum Kablo: Halojen Free, topraklama bağlantılı



## SIVA ALTI ÇİFT PARABOLİK ARMATÜRLER

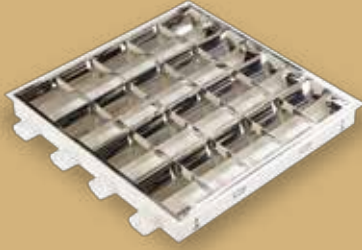

Kod	Cinsi	Ampül	Balast	Amb. Ad.	Koli Ad.	Fiyat (₺)
12 118 003 001 03001	1x18 W	T26	Elektronik	2	10	143.00
12 218 003 001 03002	2x18 W	T26	Elektronik	2	10	145.00
12 418 003 001 03003	4x18 W	T26	Elektronik	2	6	175.00
12 136 003 001 03004	1x36 W	T26	Elektronik	2	4	177.00
12 236 003 001 03005	2x36 W	T26	Elektronik	2	4	179.00
12 436 003 001 03006	4x36 W	T26	Elektronik	2	2	385.00

Gövde : DKP Sac Boya: Elektrostatik toz Duy: Darbe ve ısıya dayanıklı PC. Balast: Elektronik (50.000) saat ömürlü  
Reflektör : 5+2 Lamel yüksek saflıkta anodize alüminyum Kablo: Halojen Free, topraklama bağlantılı

## SIVA ALTI PRİZMATİK LENSLİ ARMATÜRLER



Kod	Cinsi	Ampül	Balast	Amb. Ad.	Koli Ad.	Fiyat (₺)
12 118 003 001 03007	1x18 W	T26	Elektronik	2	10	137.00
12 218 003 001 03008	2x18 W	T26	Elektronik	2	10	139.00
12 418 003 001 03009	4x18 W	T26	Elektronik	2	6	171.00
12 136 003 001 03010	1x36 W	T26	Elektronik	2	4	173.00
12 236 003 001 03011	2x36 W	T26	Elektronik	2	4	176.00
12 436 003 001 03012	4x36 W	T26	Elektronik	2	2	395.00

Gövde : DKP Sac Boya: Elektrostatik toz Duy: Darbe ve ısıya dayanıklı PC. Balast: Elektronik (50.000) saat ömürlü  
Lens: Akrilik esaslı mor ötesi stabilizatörlü prizmatik Çerçeve: Alüminyum ekstrüzyon Kablo: Halojen Free, topraklama bağlantılı

## SIVA ALTI OPAL LENSLİ ARMATÜRLER



Kod	Cinsi	Ampül	Balast	Amb. Ad.	Koli Ad.	Fiyat (₺)
12 214 003 001 03150	1x18 W	T26	Elektronik	2	10	147.00
12 314 003 001 03151	2x18 W	T26	Elektronik	2	10	149.00
12 414 003 001 03152	4x18 W	T26	Elektronik	2	6	181.00
12 228 003 001 03153	1x36 W	T26	Elektronik	2	4	183.00
12 328 003 001 03154	2x36 W	T26	Elektronik	2	4	186.00
12 428 003 001 03155	4x36 W	T26	Elektronik	2	2	415.00

Gövde : DKP Sac Boya: Elektrostatik toz Duy: Darbe ve ısıya dayanıklı PC. Balast: Elektronik (50.000) saat ömürlü  
Lens: Akrilik esaslı mor ötesi stabilizatörlü opal Çerçeve: Alüminyum ekstrüzyon Kablo: Halojen Free, topraklama bağlantılı

## SIVA ALTI LOUVER PETEKLİ ARMATÜRLER

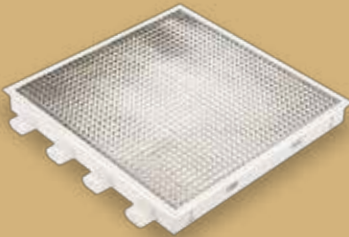

Kod	Cinsi	Ampül	Balast	Amb. Ad.	Koli Ad.	Fiyat (₺)
12 118 003 001 03013	1x18 W	T26	Elektronik	2	10	195.00
12 218 003 001 03014	2x18 W	T26	Elektronik	2	10	197.00
12 418 003 001 03015	4x18 W	T26	Elektronik	2	6	286.00
12 136 003 001 03016	1x36 W	T26	Elektronik	2	4	288.00
12 236 003 001 03017	2x36 W	T26	Elektronik	2	4	291.00
12 436 003 001 03018	4x36 W	T26	Elektronik	2	2	595.00

Gövde : DKP Sac Boya: Elektrostatik toz Duy: Darbe ve ısıya dayanıklı PC. Balast: Elektronik (50.000) saat ömürlü  
Lens: Akrilik esaslı parabolik ayna petekli Çerçeve: DKP Sac Kablo: Halojen Free, topraklama bağlantılı

## T8 SIVA ALTI PERFORE KAPAKLI ARMATÜRLER



Kod	Cinsi	Ampül	Balast	Amb. Ad.	Koli Ad.	Fiyat (₺)
12 218 003 001 03162	2x18 W	T26	Elektronik	2	10	213.00
12 418 003 001 03163	4x18 W	T26	Elektronik	2	6	265.00
12 236 003 001 03164	2x36 W	T26	Elektronik	2	4	271.00
12 436 003 001 03165	4x36 W	T26	Elektronik	2	2	519.00

Gövde : DKP Sac Boya: Elektrostatik toz Duy: Darbe ve ısıya dayanıklı PC. Balast: Elektronik (50.000) saat ömürlü  
Reflektör : Yüksek saflıkta anodize alüminyum Kablo: Halojen Free, topraklama bağlantılı



## SIVA ÜSTÜ ÇİFT PARABOLİK ARMATÜRLER



Kod	Cinsi	Ampül	Balast	Amb. Ad.	Koli Ad.	Fiyat (₺)
22 118 003 001 03019	1x18 W	T26	Elektronik	2	10	147.00
22 218 003 001 03020	2x18 W	T26	Elektronik	2	10	149.00
22 418 003 001 03021	4x18 W	T26	Elektronik	2	6	179.00
22 136 003 001 03022	1x36 W	T26	Elektronik	2	4	181.00
22 236 003 001 03023	2x36 W	T26	Elektronik	2	4	183.00
22 436 003 001 03024	4x36 W	T26	Elektronik	2	2	393.00

Gövde : DKP Sac Boya: Elektrostatik toz Duy: Darbe ve ısıya dayanıklı PC. Balast: Elektronik (50.000) saat ömürlü  
Reflektör : 5+2 Lamel yüksek saflıkta anodize alüminyum Kablo: Halojen Free, topraklama bağlantılı

## SIVA ÜSTÜ PRİZMATİK LENSLİ ARMATÜRLER



Kod	Cinsi	Ampül	Balast	Amb. Ad.	Koli Ad.	Fiyat (₺)
22 118 003 001 03025	1x18 W	T26	Elektronik	2	10	141.00
22 218 003 001 03026	2x18 W	T26	Elektronik	2	10	143.00
22 418 003 001 03027	4x18 W	T26	Elektronik	2	6	175.00
22 136 003 001 03028	1x36 W	T26	Elektronik	2	4	177.00
22 236 003 001 03029	2x36 W	T26	Elektronik	2	4	179.00
22 436 003 001 03030	4x36 W	T26	Elektronik	2	2	403.00

Gövde : DKP Sac Boya: Elektrostatik toz Duy: Darbe ve ısıya dayanıklı PC. Balast: Elektronik (50.000) saat ömürlü  
Lens: Akrilik esaslı mor ötesi stabilizatörlü prizmatik Çerçeve: Alüminyum ekstrüzyon Kablo: Halojen Free, topraklama bağlantılı

## SIVA ÜSTÜ OPAL LENSLİ ARMATÜRLER



Kod	Cinsi	Ampül	Balast	Amb. Ad.	Koli Ad.	Fiyat (₺)
22 118 003 001 03156	1x18 W	T26	Elektronik	2	10	151.00
22 218 003 001 03157	2x18 W	T26	Elektronik	2	10	153.00
22 418 003 001 03158	4x18 W	T26	Elektronik	2	6	185.00
22 136 003 001 03159	1x36 W	T26	Elektronik	2	4	187.00
22 236 003 001 03160	2x36 W	T26	Elektronik	2	4	189.00
22 436 003 001 03161	4x36 W	T26	Elektronik	2	2	423.00

Gövde : DKP Sac Boya: Elektrostatik toz Duy: Darbe ve ısıya dayanıklı PC. Balast: Elektronik (50.000) saat ömürlü  
Lens: Akrilik esaslı mor ötesi stabilizatörlü opal Çerçeve: Alüminyum ekstrüzyon Kablo: Halojen Free, topraklama bağlantılı

## SIVA ÜSTÜ LOUVER PETEKLİ ARMATÜRLER



Kod	Cinsi	Ampül	Balast	Amb. Ad.	Koli Ad.	Fiyat (₺)
22 118 003 001 03031	1x18 W	T26	Elektronik	2	10	199.00
22 218 003 001 03032	2x18 W	T26	Elektronik	2	10	201.00
22 418 003 001 03033	4x18 W	T26	Elektronik	2	6	290.00
22 136 003 001 03034	1x36 W	T26	Elektronik	2	4	292.00
22 236 003 001 03035	2x36 W	T26	Elektronik	2	4	295.00
22 436 003 001 03036	4x36 W	T26	Elektronik	2	2	603.00

Gövde : DKP Sac Boya: Elektrostatik toz Duy: Darbe ve ısıya dayanıklı PC. Balast: Elektronik (50.000) saat ömürlü  
Lens: Akrilik esaslı parabolik ayna petekli Çerçeve: DKP Sac Kablo: Halojen Free, topraklama bağlantılı

## T8 SIVA ÜSTÜ PERFORE KAPAKLI ARMATÜRLER



Kod	Cinsi	Ampül	Balast	Amb. Ad.	Koli Ad.	Fiyat (₺)
22 218 003 001 03166	2x18 W	T26	Elektronik	2	10	217.00
22 418 003 001 03167	4x18 W	T26	Elektronik	2	6	269.00
22 236 003 001 03168	2x36 W	T26	Elektronik	2	4	275.00
22 436 003 001 03169	4x36 W	T26	Elektronik	2	2	527.00

Gövde : DKP Sac Boya: Elektrostatik toz Duy: Darbe ve ısıya dayanıklı PC. Balast: Elektronik (50.000) saat ömürlü  
Reflektör : Yüksek saflıkta anodize alüminyum Kablo: Halojen Free, topraklama bağlantılı



## T5 SIVA ALTI PERFORE KAPAKLI ARMATÜRLER



Kod	Cinsi	Ampül	Balast	Amb. Ad.	Koli Ad.	Fiyat (₺)
12 214 003 001 03114	2x14 W	T16	Elektronik	2	10	201.00
12 314 003 001 03122	3x14 W	T16	Elektronik	2	6	225.00
12 414 003 001 03115	4x14 W	T16	Elektronik	2	6	225.00
12 228 003 001 03116	2x28 W	T16	Elektronik	2	4	235.00
12 328 003 001 03123	3x28 W	T16	Elektronik	2	2	459.00
12 428 003 001 03117	4x28 W	T16	Elektronik	2	2	459.00

Gövde: DKP Sac Boya: Elektrostatik toz Duy: Darbe ve ısıya dayanıklı PC. Balast: Elektronik (50.000) saat ömürlü  
Reflektör: Yüksek saflıkta anodize alüminyum Kablo: Halojen Free, topraklama bağlantılı

## T5 SIVA ALTI PRİZMATİK LENSİ ARMATÜRLER



Kod	Cinsi	Ampül	Balast	Amb. Ad.	Koli Ad.	Fiyat (₺)
12 214 003 001 03124	2x14 W	T16	Elektronik	2	10	206.00
12 314 003 001 03125	3x14 W	T16	Elektronik	2	6	229.00
12 414 003 001 03126	4x14 W	T16	Elektronik	2	6	229.00
12 228 003 001 03127	2x28 W	T16	Elektronik	2	4	239.00
12 328 003 001 03128	3x28 W	T16	Elektronik	2	4	469.00
12 428 003 001 03129	4x28 W	T16	Elektronik	2	2	469.00

Gövde: DKP Sac Boya: Elektrostatik toz Duy: Darbe ve ısıya dayanıklı PC. Balast: Elektronik (50.000) saat ömürlü  
Lens: Akrilik esaslı mor ötesi stabilizatörlü prizmatik Çerçeve: Alüminyum ekstrüzyon Kablo: Halojen Free, topraklama bağlantılı

## T5 SIVA ALTI OPAL LENSİ ARMATÜRLER

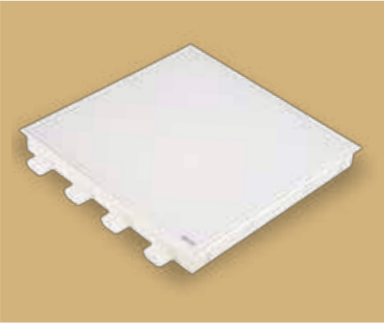

Kod	Cinsi	Ampül	Balast	Amb. Ad.	Koli Ad.	Fiyat (₺)
12 214 003 001 03130	2x14 W	T16	Elektronik	2	10	216.00
12 314 003 001 03131	3x14 W	T16	Elektronik	2	6	239.00
12 414 003 001 03132	4x14 W	T16	Elektronik	2	6	239.00
12 228 003 001 03133	2x28 W	T16	Elektronik	2	4	249.00
12 328 003 001 03134	3x28 W	T16	Elektronik	2	4	479.00
12 428 003 001 03135	4x28 W	T16	Elektronik	2	2	479.00

Gövde: DKP Sac Boya: Elektrostatik toz Duy: Darbe ve ısıya dayanıklı PC. Balast: Elektronik (50.000) saat ömürlü  
Lens: Akrilik esaslı mor ötesi stabilizatörlü opal Çerçeve: Alüminyum ekstrüzyon Kablo: Halojen Free, topraklama bağlantılı

## SIVA ALTI REFLEKTÖRLÜ - LENSİ ARMATÜRLER 300X300X60



Kod	Cinsi	Ampül	Balast	Amb. Ad.	Koli Ad.	Fiyat (₺)
12 218 003 001 03192	2x18 W Çift Parabolik	PL-C	Elektronik	4	24	103.00
12 218 003 001 03193	2x18 W Prizmatik	PL-C	Elektronik	4	24	113.00
12 218 003 001 03194	2x18 W Opal	PL-C	Elektronik	4	24	116.00
12 218 003 001 03195	2x18 W Louver	PL-C	Elektronik	4	24	154.00
12 218 002 001 03196	2x18 W Çift Parabolik	PL-C	Manyetik	4	24	75.00
12 218 002 001 03197	2x18 W Prizmatik	PL-C	Manyetik	4	24	83.00
12 218 002 001 03198	2x18 W Opal	PL-C	Manyetik	4	24	86.00
12 218 002 001 03199	2x18 W Louver	PL-C	Manyetik	4	24	114.00

Gövde: DKP Sac Boya: Elektrostatik toz Duy: Darbe ve ısıya dayanıklı PC. Balast: Bakır Sargılı - Elektronik  
Lens: Akrilik esaslı parabolik ayna petekli - Çift parabolik, yüksek saflıkta alüminyum anodize Çerçeve: Alüminyum profil

## E-27 DUYLU SIVA ALTI REFLEKTÖRLÜ - LENSİ ARMATÜRLER 300X300X60



Kod	Cinsi	Amb. Ad.	Koli Ad.	Fiyat (₺)
12 225 000 001 03221	2xE-27 Duyulu Prizmatik Lensli	4	24	53.00
12 225 000 001 03222	2xE-27 Duyulu Opal Lensli	4	24	57.00

Gövde: DKP Sac Boya: Elektrostatik toz Duy: Porselen E-27  
Lens: Akrilik esaslı mor ötesi stabilizatörlü prizmatik, akrilik opal lensli Çerçeve: Alüminyum profil

## T5 SIVA ÜSTÜ PERFORE KAPAKLI ARMATÜRLER



Kod	Cinsi	Ampül	Balast	Amb. Ad.	Koli Ad.	Fiyat (₺)
22 214 003 001 03118	2x14 W	T16	Elektronik	2	10	205.00
22 314 003 001 03136	3x14 W	T16	Elektronik	2	6	229.00
22 414 003 001 03119	4x14 W	T16	Elektronik	2	6	229.00
22 228 003 001 03120	2x28 W	T16	Elektronik	2	4	239.00
22 328 003 001 03137	3x28 W	T16	Elektronik	2	2	467.00
22 428 003 001 03121	4x28 W	T16	Elektronik	2	2	467.00

Gövde: DKP Sac Boya: Elektrostatik toz Duy: Darbe ve ısıya dayanıklı PC. Balast: Elektronik (50.000) saat ömürlü  
Reflektör: Yüksek saflıkta anodize alüminyum Kablo: Halojen Free, topraklama bağlantılı

## T5 SIVA ÜSTÜ PRİZMATİK LENSİ ARMATÜRLER



Kod	Cinsi	Ampül	Balast	Amb. Ad.	Koli Ad.	Fiyat (₺)
22 214 003 001 03138	2x14 W	T16	Elektronik	2	10	210.00
22 314 003 001 03139	3x14 W	T16	Elektronik	2	6	233.00
22 414 003 001 03140	4x14 W	T16	Elektronik	2	6	233.00
22 228 003 001 03141	2x28 W	T16	Elektronik	2	4	243.00
22 328 003 001 03142	3x28 W	T16	Elektronik	2	4	477.00
22 428 003 001 03143	4x28 W	T16	Elektronik	2	2	477.00

Gövde: DKP Sac Boya: Elektrostatik toz Duy: Darbe ve ısıya dayanıklı PC. Balast: Elektronik (50.000) saat ömürlü  
Lens: Akrilik esaslı mor ötesi stabilizatörlü prizmatik Çerçeve: Alüminyum ekstrüzyon Kablo: Halojen Free, topraklama bağlantılı

## T5 SIVA ÜSTÜ OPAL LENSİ ARMATÜRLER



Kod	Cinsi	Ampül	Balast	Amb. Ad.	Koli Ad.	Fiyat (₺)
22 214 003 001 03144	2x14 W	T16	Elektronik	2	10	219.00
22 314 003 001 03145	3x14 W	T16	Elektronik	2	6	243.00
22 414 003 001 03146	4x14 W	T16	Elektronik	2	6	243.00
22 228 003 001 03147	2x28 W	T16	Elektronik	2	4	254.00
22 328 003 001 03148	3x28 W	T16	Elektronik	2	4	487.00
22 428 003 001 03149	4x28 W	T16	Elektronik	2	2	487.00

Gövde: DKP Sac Boya: Elektrostatik toz Duy: Darbe ve ısıya dayanıklı PC. Balast: Elektronik (50.000) saat ömürlü  
Lens: Akrilik esaslı mor ötesi stabilizatörlü opal Çerçeve: Alüminyum ekstrüzyon Kablo: Halojen Free, topraklama bağlantılı

## SIVA ÜSTÜ REFLEKTÖRLÜ - LENSİ ARMATÜRLER 300X300X60



Kod	Cinsi	Ampül	Balast	Amb. Ad.	Koli Ad.	Fiyat (₺)
22 218 003 001 03200	2x18 W Çift Parabolik	PL-C	Elektronik	4	20	105.00
22 218 003 001 03201	2x18 W Prizmatik	PL-C	Elektronik	4	20	115.00
22 218 003 001 03202	2x18 W Opal	PL-C	Elektronik	4	20	118.00
22 218 003 001 03203	2x18 W Louver	PL-C	Elektronik	4	20	156.00
22 218 002 001 03204	2x18 W Çift Parabolik	PL-C	Manyetik	4	20	77.00
22 218 002 001 03205	2x18 W Prizmatik	PL-C	Manyetik	4	20	85.00
22 218 002 001 03206	2x18 W Opal	PL-C	Manyetik	4	20	88.00
22 218 002 001 03207	2x18 W Louver	PL-C	Manyetik	4	20	196.00

Gövde: DKP Sac Boya: Elektrostatik toz Duy: Darbe ve ısıya dayanıklı PC. Balast: Bakır Sargılı - Elektronik  
Lens: Akrilik esaslı parabolik ayna petekli - Çift parabolik, yüksek saflıkta alüminyum anodize Çerçeve: Alüminyum profil

## E-27 DUYLU SIVA ÜSTÜ REFLEKTÖRLÜ - LENSİ ARMATÜRLER 300X300X60



Kod	Cinsi	Amb. Ad.	Koli Ad.	Fiyat (₺)
22 225 000 001 03225	2xE-27 Duyulu Prizmatik Lensli	4	20	55.00
22 225 000 001 03226	2xE-27 Duyulu Opal Lensli	4	20	59.00

Gövde: DKP Sac Boya: Elektrostatik toz Duy: Porselen E-27  
Lens: Akrilik esaslı mor ötesi stabilizatörlü prizmatik, akrilik opal lensli Çerçeve: Alüminyum profil



## SIVA ALTI ENDİREKT SERİSİ ARMATÜRLER



Kod	Cinsi	Ampül	Balast	Amb. Ad.	Koli Ad.	Fiyat (₺)
12 218 002 001 03401	2x18 W	T26	Manyetik	2	4	<b>183.00</b>
12 236 002 001 03402	2x36 W	TCL	Manyetik	2	4	<b>225.00</b>
12 255 003 001 03403	2x55 W	TCL	Elektronik	2	4	<b>251.00</b>
12 214 003 001 03404	2x14 W	T16	Elektronik	2	4	<b>251.00</b>

Gövde: DKP Sac Boya: Mat elektrostatik toz Duy: Darbe ve ısıya dayanıklı PC. Kablo: Halojen Free, topraklama bağlantılı  
Balast: Bakır Sargılı ve Elektronik Reflektör: 0.40 mm DKP Sac Kapak: Perfore DKP Sac

## SIVA ALTI DİREKT-ENDİREKT SERİSİ ARMATÜRLER



Kod	Cinsi	Ampül	Balast	Amb. Ad.	Koli Ad.	Fiyat (₺)
12 318 002 001 03405	3x18 W	T26	Manyetik	2	4	<b>225.00</b>
12 336 002 001 03406	3x36 W	TCL	Manyetik	2	4	<b>252.00</b>
12 355 003 001 03407	3x55 W	TCL	Elektronik	2	4	<b>374.00</b>
12 314 003 001 03408	3x14 W	T16	Elektronik	2	4	<b>309.00</b>

Gövde: DKP Sac Boya: Mat elektrostatik toz Duy: Darbe ve ısıya dayanıklı PC. Balast: Bakır Sargılı ve Elektronik Reflektör: Yüksek saflıkta anodize alüminyum Kapak: Perfore DKP Sac Kablo: Halojen Free, topraklama bağlantılı

## SIVA ALTI DİREKT-ENDİREKT LOUVER SERİSİ ARMATÜRLER



Kod	Cinsi	Ampül	Balast	Amb. Ad.	Koli Ad.	Fiyat (₺)
12 318 002 001 03409	3x18 W	T26	Manyetik	2	4	<b>248.00</b>
12 336 002 001 03410	3x36 W	TCL	Manyetik	2	4	<b>305.00</b>
12 355 003 001 03411	3x55 W	TCL	Elektronik	2	4	<b>378.00</b>
12 314 003 001 03412	3x14 W	T16	Elektronik	2	4	<b>316.00</b>

Gövde: DKP Sac Boya: Mat elektrostatik toz Duy: Darbe ve ısıya dayanıklı PC. Balast: Bakır Sargılı ve Elektronik Reflektör: Akriklilik esaslı ayna petekli parabolik Kapak: Perfore DKP Sac Kablo: Halojen Free, topraklama bağlantılı



**İŞILDAR**  
LIGHTING SYSTEM

**İŞILDAR**  
LIGHTING SYSTEM

**01**

**CLIP-IN Ofis Armatürleri**

## CLIP-IN ÇİFT PARABOLİK ARMATÜRLER

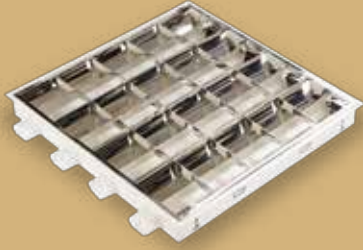

Kod	Cinsi	Ampül	Balast	Amb. Ad.	Koli Ad.	Fiyat (₺)
12 118 002 001 07001	1x18 W	T26	Manyetik	2	8	105.00
12 218 002 001 07002	2x18 W	T26	Manyetik	2	8	107.00
12 418 002 001 07003	4x18 W	T26	Manyetik	2	6	151.00
12 136 002 001 07004	1x36 W	T26	Manyetik	2	2	153.00
12 236 002 001 07005	2x36 W	T26	Manyetik	2	2	165.00
12 436 002 001 07006	4x36 W	T26	Manyetik	2	2	315.00

Gövde : DKP Sac Boya: Elektrostatik toz Duy: Darbe ve ısıya dayanıklı PC. Balast: Bakır Sargılı Starter: General marka  
Reflektör: 5+2 Lamel yüksek saflıkta anodize alüminyum Kablo: Halojen Free, topraklama bağlantılı

## CLIP-IN PRİZMATİK LENSLİ ARMATÜRLER



Kod	Cinsi	Ampül	Balast	Amb. Ad.	Koli Ad.	Fiyat (₺)
12 118 002 001 07045	1x18 W	T26	Manyetik	2	8	99.00
12 218 002 001 07046	2x18 W	T26	Manyetik	2	8	101.00
12 418 002 001 07047	4x18 W	T26	Manyetik	2	6	143.00
12 136 002 001 07048	1x36 W	T26	Manyetik	2	2	145.00
12 236 002 001 07049	2x36 W	T26	Manyetik	2	2	148.00
12 436 002 001 07050	4x36 W	T26	Manyetik	2	2	358.00

Gövde : DKP Sac Boya: Elektrostatik toz Duy: Darbe ve ısıya dayanıklı PC. Balast: Bakır Sargılı Starter: General marka  
Lens: Akrilik esaslı mor ötesi stabilizatörlü prizmatik Çerçeve: Alüminyum ekstrüzyon Kablo: Halojen Free, topraklama bağlantılı

## CLIP-IN OPAL LENSLİ ARMATÜRLER



Kod	Cinsi	Ampül	Balast	Amb. Ad.	Koli Ad.	Fiyat (₺)
12 118 002 001 07021	1x18 W	T26	Manyetik	2	8	109.00
12 218 002 001 07022	2x18 W	T26	Manyetik	2	8	111.00
12 418 002 001 07023	4x18 W	T26	Manyetik	2	6	153.00
12 136 002 001 07024	1x36 W	T26	Manyetik	2	2	155.00
12 236 002 001 07025	2x36 W	T26	Manyetik	2	2	158.00
12 436 002 001 07026	4x36 W	T26	Manyetik	2	2	378.00

Gövde : DKP Sac Boya: Elektrostatik toz Duy: Darbe ve ısıya dayanıklı PC. Balast: Bakır Sargılı Starter: General marka  
Lens: Akrilik esaslı mor ötesi stabilizatörlü opal Çerçeve: Alüminyum ekstrüzyon Kablo: Halojen Free, topraklama bağlantılı

## CLIP-IN LOUVER PETEKLİ ARMATÜRLER

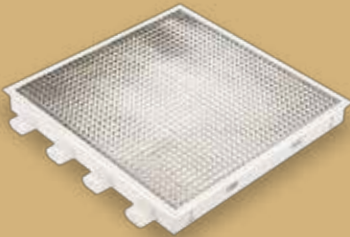

Kod	Cinsi	Ampül	Balast	Amb. Ad.	Koli Ad.	Fiyat (₺)
12 118 002 001 07033	1x18 W	T26	Manyetik	2	8	152.00
12 218 002 001 07034	2x18 W	T26	Manyetik	2	8	154.00
12 418 002 001 07035	4x18 W	T26	Manyetik	2	6	251.00
12 136 002 001 07036	1x36 W	T26	Manyetik	2	2	253.00
12 236 002 001 07037	2x36 W	T26	Manyetik	2	2	256.00
12 436 002 001 07038	4x36 W	T26	Manyetik	2	2	491.00

Gövde : DKP Sac Boya: Elektrostatik toz Duy: Darbe ve ısıya dayanıklı PC. Balast: Bakır Sargılı Starter: General marka  
Lens: Akrilik esaslı parabolik ayna petekli Çerçeve: DKP Sac Kablo: Halojen Free, topraklama bağlantılı

## T8 CLIP-IN PERFORE KAPAKLI ARMATÜRLER



Kod	Cinsi	Ampül	Balast	Amb. Ad.	Koli Ad.	Fiyat (₺)
12 218 002 001 07013	2x18 W	T26	Manyetik	2	8	163.00
12 418 002 001 07014	4x18 W	T26	Manyetik	2	6	229.00
12 236 002 001 07015	2x36 W	T26	Manyetik	2	2	244.00
12 436 002 001 07016	4x36 W	T26	Manyetik	2	2	431.00

Gövde : DKP Sac Boya: Elektrostatik toz Duy: Darbe ve ısıya dayanıklı PC. Balast: Bakır Sargılı Starter: General marka  
Reflektör: Yüksek saflıkta anodize alüminyum Kablo: Halojen Free, topraklama bağlantılı

## CLIP-IN ÇİFT PARABOLİK ARMATÜRLER



Kod	Cinsi	Ampül	Balast	Amb. Ad.	Koli Ad.	Fiyat (₺)
12 118 003 001 07007	1x18 W	T26	Elektronik	2	8	159.00
12 218 003 001 07008	2x18 W	T26	Elektronik	2	8	161.00
12 418 003 001 07009	4x18 W	T26	Elektronik	2	6	191.00
12 136 003 001 07010	1x36 W	T26	Elektronik	2	2	193.00
12 236 003 001 07011	2x36 W	T26	Elektronik	2	2	196.00
12 436 003 001 07012	4x36 W	T26	Elektronik	2	2	401.00

Gövde : DKP Sac Boya: Elektrostatik toz Duy: Darbe ve ısıya dayanıklı PC. Balast: Elektronik (50.000) saat ömürlü  
Reflektör : 5+2 Lamel yüksek saflıkta anodize alüminyum Kablo: Halojen Free, topraklama bağlantılı

## CLIP-IN PRİZMATİK LENSLİ ARMATÜRLER



Kod	Cinsi	Ampül	Balast	Amb. Ad.	Koli Ad.	Fiyat (₺)
12 118 003 001 07051	1x18 W	T26	Elektronik	2	8	153.00
12 218 003 001 07052	2x18 W	T26	Elektronik	2	8	155.00
12 418 003 001 07053	4x18 W	T26	Elektronik	2	6	187.00
12 136 003 001 07054	1x36 W	T26	Elektronik	2	2	189.00
12 236 003 001 07055	2x36 W	T26	Elektronik	2	2	192.00
12 436 003 001 07056	4x36 W	T26	Elektronik	2	2	411.00

Gövde : DKP Sac Boya: Elektrostatik toz Duy: Darbe ve ısıya dayanıklı PC. Balast: Elektronik (50.000) saat ömürlü  
Lens: Akrilik esaslı mor ötesi stabilizatörlü prizmatik Çerçeve: Alüminyum ekstrüzyon Kablo: Halojen Free, topraklama bağlantılı

## CLIP-IN OPAL LENSLİ ARMATÜRLER



Kod	Cinsi	Ampül	Balast	Amb. Ad.	Koli Ad.	Fiyat (₺)
12 118 003 001 07027	1x18 W	T26	Elektronik	2	8	163.00
12 218 003 001 07028	2x18 W	T26	Elektronik	2	8	165.00
12 418 003 001 07029	4x18 W	T26	Elektronik	2	6	197.00
12 136 003 001 07030	1x36 W	T26	Elektronik	2	2	199.00
12 236 003 001 07031	2x36 W	T26	Elektronik	2	2	202.00
12 436 003 001 07032	4x36 W	T26	Elektronik	2	2	431.00

Gövde : DKP Sac Boya: Elektrostatik toz Duy: Darbe ve ısıya dayanıklı PC. Balast: Elektronik (50.000) saat ömürlü  
Lens: Akrilik esaslı mor ötesi stabilizatörlü opal Çerçeve: Alüminyum ekstrüzyon Kablo: Halojen Free, topraklama bağlantılı

## CLIP-IN LOUVER PETEKLİ ARMATÜRLER

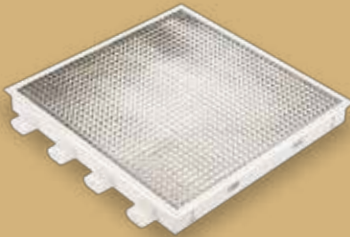

Kod	Cinsi	Ampül	Balast	Amb. Ad.	Koli Ad.	Fiyat (₺)
12 118 003 001 07039	1x18 W	T26	Elektronik	2	8	211.00
12 218 003 001 07040	2x18 W	T26	Elektronik	2	8	213.00
12 418 003 001 07041	4x18 W	T26	Elektronik	2	6	302.00
12 136 003 001 07042	1x36 W	T26	Elektronik	2	2	304.00
12 236 003 001 07043	2x36 W	T26	Elektronik	2	2	307.00
12 436 003 001 07044	4x36 W	T26	Elektronik	2	2	611.00

Gövde : DKP Sac Boya: Elektrostatik toz Duy: Darbe ve ısıya dayanıklı PC. Balast: Elektronik (50.000) saat ömürlü  
Lens: Akrilik esaslı parabolik ayna petekli Çerçeve: DKP Sac Kablo: Halojen Free, topraklama bağlantılı

## T8 CLIP-IN PERFORE KAPAKLI ARMATÜRLER



Kod	Cinsi	Ampül	Balast	Amb. Ad.	Koli Ad.	Fiyat (₺)
12 218 003 001 07017	2x18 W	T26	Elektronik	2	8	229.00
12 418 003 001 07018	4x18 W	T26	Elektronik	2	6	281.00
12 236 003 001 07019	2x36 W	T26	Elektronik	2	2	287.00
12 436 003 001 07020	4x36 W	T26	Elektronik	2	2	535.00

Gövde : DKP Sac Boya: Elektrostatik toz Duy: Darbe ve ısıya dayanıklı PC. Balast: Elektronik (50.000) saat ömürlü  
Reflektör : Yüksek saflıkta anodize alüminyum Kablo: Halojen Free, topraklama bağlantılı

**T5 CLIP-IN PERFORE KAPAKLI ARMATÜRLER**

Kod	Cinsi	Ampül	Balast	Amb. Ad.	Koli Ad.	Fiyat (₺)
12 214 003 001 07057	2x14 W	T16	Elektronik	2	8	217.00
12 314 003 001 07058	3x14 W	T16	Elektronik	2	6	241.00
12 414 003 001 07059	4x14 W	T16	Elektronik	2	6	241.00
12 228 003 001 07060	2x28 W	T16	Elektronik	2	2	251.00
12 328 003 001 07061	3x28 W	T16	Elektronik	2	2	475.00
12 428 003 001 07062	4x28 W	T16	Elektronik	2	2	475.00

Gövde : DKP Sac Boya: Elektrostatik toz Duy: Darbe ve ısıya dayanıklı PC. Balast: Elektronik (50.000) saat ömürlü  
 Reflektör : Yüksek saflıkta anodize alüminyum Kablo: Halojen Free, topraklama bağlantılı

**T5 CLIP-IN PRİZMATİK LENSİ ARMATÜRLER**

Kod	Cinsi	Ampül	Balast	Amb. Ad.	Koli Ad.	Fiyat (₺)
12 214 003 001 07063	2x14 W	T16	Elektronik	2	8	222.00
12 314 003 001 07064	3x14 W	T16	Elektronik	2	6	245.00
12 414 003 001 07065	4x14 W	T16	Elektronik	2	6	245.00
12 228 003 001 07066	2x28 W	T16	Elektronik	2	2	255.00
12 328 003 001 07067	3x28 W	T16	Elektronik	2	2	485.00
12 428 003 001 07068	4x28 W	T16	Elektronik	2	2	485.00

Gövde : DKP Sac Boya: Elektrostatik toz Duy: Darbe ve ısıya dayanıklı PC. Balast: Elektronik (50.000) saat ömürlü  
 Lens: Akrilik esaslı mor ötesi stabilizatörlü prizmatik Çerçeve: Alüminyum ekstrüzyon Kablo: Halojen Free, topraklama bağlantılı

**T5 CLIP-IN OPAL LENSİ ARMATÜRLER**

Kod	Cinsi	Ampül	Balast	Amb. Ad.	Koli Ad.	Fiyat (₺)
12 214 003 001 07138	2x14 W	T16	Elektronik	2	8	232.00
12 314 003 001 07139	3x14 W	T16	Elektronik	2	6	255.00
12 414 003 001 07140	4x14 W	T16	Elektronik	2	6	255.00
12 228 003 001 07141	2x28 W	T16	Elektronik	2	2	265.00
12 328 003 001 07142	3x28 W	T16	Elektronik	2	2	495.00
12 428 003 001 07143	4x28 W	T16	Elektronik	2	2	495.00

Gövde : DKP Sac Boya: Elektrostatik toz Duy: Darbe ve ısıya dayanıklı PC. Balast: Elektronik (50.000) saat ömürlü  
 Lens: Akrilik esaslı mor ötesi stabilizatörlü opal Çerçeve: Alüminyum ekstrüzyon Kablo: Halojen Free, topraklama bağlantılı

**CLIP-IN REFLEKTÖRLÜ - LENSİ ARMATÜRLER 300X300X60**

Kod	Cinsi	Ampül	Balast	Amb. Ad.	Koli Ad.	Fiyat (₺)
12 218 003 001 07069	2x18 W Çift Parabolik	PL-C	Elektronik	4	24	114.00
12 218 003 001 07070	2x18 W Prizmatik	PL-C	Elektronik	4	24	124.00
12 218 003 001 07071	2x18 W Opal	PL-C	Elektronik	4	24	127.00
12 218 003 001 07072	2x18 W Louver	PL-C	Elektronik	4	24	165.00
12 218 002 001 07073	2x18 W Çift Parabolik	PL-C	Manyetik	4	24	86.00
12 218 002 001 07074	2x18 W Prizmatik	PL-C	Manyetik	4	24	94.00
12 218 002 001 07075	2x18 W Opal	PL-C	Manyetik	4	24	97.00
12 218 002 001 07076	2x18 W Louver	PL-C	Manyetik	4	24	125.00

Gövde: DKP Sac Boya: Elektrostatik toz Duy: Darbe ve ısıya dayanıklı PC. Balast: Bakır Sargılı - Elektronik  
 Lens: Akrilik esaslı parabolik ayna petekli - Çift parabolik, yüksek saflıkta anodize alüminyum Çerçeve: Alüminyum profil  
 Kablo: Halojen Free, topraklama bağlantılı

**E-27 DUYLU CLIP-IN REFLEKTÖRLÜ - LENSİ ARMATÜRLER 300X300X60**

Kod	Cinsi	Amb. Ad.	Koli Ad.	Fiyat (₺)
12 225 000 001 07077	2xE-27 Duyulu Prizmatik Lensli	4	24	64.00
12 225 000 001 07078	2xE-27 Duyulu Opal Lensli	4	24	68.00

Gövde: DKP Sac Boya: Elektrostatik toz Duy: Porselen E-27 Kablo: Halojen Free, topraklama bağlantılı  
 Lens: Akrilik esaslı mor ötesi stabilizatörlü prizmatik, akrilik opal lensli Çerçeve: Alüminyum profil



## CLIP-IN ENDİREKT SERİSİ ARMATÜRLER



Kod	Cinsi	Ampül	Balast	Amb. Ad.	Koli Ad.	Fiyat (₺)
12 218 002 001 07082	2x18 W	T26	Manyetik	2	4	199.00
12 236 002 001 07079	2x36 W	TCL	Manyetik	2	4	241.00
12 255 003 001 07084	2x55 W	TCL	Elektronik	2	4	267.00
12 214 003 001 07085	2x14 W	T16	Elektronik	2	4	267.00

Gövde: DKP Sac Boya: Mat elektrostatik toz Duy: Darbe ve ısıya dayanıklı PC.

Balast: Bakır Sargılı ve Elektronik Reflektör: 0.40 mm DKP Sac Kapak: Perfore DKP Sac Kablo: Halojen Free, topraklama bağlantılı

## CLIP-IN DİREKT-ENDİREKT SERİSİ ARMATÜRLER



Kod	Cinsi	Ampül	Balast	Amb. Ad.	Koli Ad.	Fiyat (₺)
12 318 002 001 07144	3x18 W	T26	Manyetik	2	4	241.00
12 336 002 001 07087	3x36 W	TCL	Manyetik	2	4	268.00
12 355 003 001 07092	3x55 W	TCL	Elektronik	2	4	389.00
12 314 003 001 07093	3x14 W	T16	Elektronik	2	4	329.00

Gövde: DKP Sac Boya: Mat elektrostatik toz Duy: Darbe ve ısıya dayanıklı PC.

Balast: Bakır Sargılı ve Elektronik Reflektör: Yüksek saflıkta anodize alüminyum Kapak: Perfore DKP Sac

Kablo: Halojen Free, topraklama bağlantılı

## CLIP-IN DİREKT-ENDİREKT LOUVER SERİSİ ARMATÜRLER



Kod	Cinsi	Ampül	Balast	Amb. Ad.	Koli Ad.	Fiyat (₺)
12 318 002 001 07145	3x18 W	T26	Manyetik	2	4	264.00
12 336 002 001 07095	3x36 W	TCL	Manyetik	2	4	321.00
12 355 003 001 07100	3x55 W	TCL	Elektronik	2	4	394.00
12 314 003 001 07101	3x14 W	T16	Elektronik	2	4	332.00

Gövde: DKP Sac Boya: Mat elektrostatik toz Duy: Darbe ve ısıya dayanıklı PC.

Balast: Bakır Sargılı ve Elektronik Reflektör: Akirlik esaslı parabolik ayna petekli Kapak: Perfore DKP Sac

Kablo: Halojen Free, topraklama bağlantılı



IŞILDAR  
LIGHTING SYSTEM



# İŞILDAR

LIGHTING SYSTEM





**İŞILDAR**  
LIGHTING SYSTEM

**STERİL ORTAM HASTAHANE ARMATÜRLERİ  
(IP 65)**

**01**

**SIVA ALTI STERİL ORTAM TEMPERLİ CAMLI ARMATÜRLER**

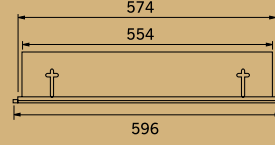

Kod	Cinsi	Ampül	Balast	Amb. Ad.	Koli Ad.	Fiyat (₺)
16 218 002 001 03170	2x18 W	T26	Manyetik	2	4	<b>249.00</b>
16 418 002 001 03171	4x18 W	T26		2	4	<b>285.00</b>
16 236 002 001 03172	2x36 W	T26		2	4	<b>319.00</b>
16 218 003 001 03170	2x18 W	T26	Elektronik	2	4	<b>299.00</b>
16 418 003 001 03171	4x18 W	T26		2	4	<b>332.00</b>
16 236 003 001 03172	2x36 W	T26		2	4	<b>367.00</b>

Gövde : DKP Sac Boya: Elektrostatik toz Duy: Darbe ve ısıya dayanıklı PC. Balast: Elektronik (50.000) saat ömürlü - Manyetik Bakır sargılı  
Reflektör : Yüksek saflıkta anodize alüminyum Cam: Tamperli Kablo: Halojen Free, topraklama bağlantılı

**SIVA ÜSTÜ STERİL ORTAM TEMPERLİ CAMLI ARMATÜRLER**

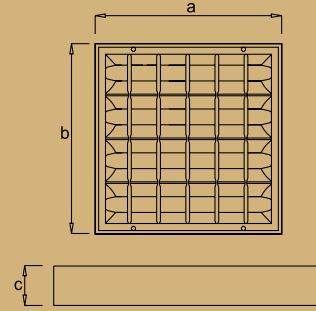

Kod	Cinsi	Ampül	Balast	Amb. Ad.	Koli Ad.	Fiyat (₺)
26 218 002 001 03173	2x18 W	T26	Manyetik	2	4	<b>286.00</b>
26 418 002 001 03174	4x18 W	T26		2	4	<b>319.00</b>
26 236 002 001 03175	2x36 W	T26		2	4	<b>355.00</b>
26 218 003 001 03173	2x18 W	T26	Elektronik	2	4	<b>332.00</b>
26 418 003 001 03174	4x18 W	T26		2	4	<b>367.00</b>
26 236 003 001 03175	2x36 W	T26		2	4	<b>399.00</b>

Gövde : DKP Sac Boya: Elektrostatik toz Duy: Darbe ve ısıya dayanıklı PC. Balast: Elektronik (50.000) saat ömürlü - Manyetik Bakır sargılı  
Reflektör : Yüksek saflıkta anodize alüminyum Cam: Tamperli Kablo: Halojen Free, topraklama bağlantılı



IŞILDAR®  
LIGHTING SYSTEM

IŞILDAR®  
LIGHTING SYSTEM

Sıva Altı Ofis Armatürleri Eko Model  
Sıva Üstü Ofis Armatürleri Eko Model  
Eko Modeli Bant Armatürleri  
Eko Model CLIP-IN Ofis Armatürleri

**EKO SERİSİ ARMATÜRLER**  
Ekonomik Modeller

02

## SIVA ALTI ÇİFT PARABOLİK ARMATÜRLER

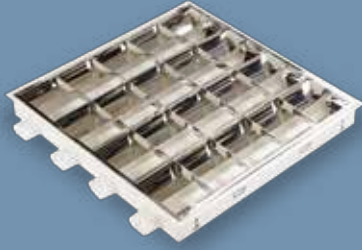

Kod	Cinsi	Ampül	Balast	Amb. Ad.	Koli Ad.	Fiyat (₺)
12 118 002 001 09059	1x18 W	T26	Manyetik	2	10	75.00
12 218 002 001 09060	2x18 W	T26	Manyetik	2	10	77.00
12 418 002 001 09061	4x18 W	T26	Manyetik	2	6	109.00
12 136 002 001 09062	1x36 W	T26	Manyetik	2	4	111.00
12 236 002 001 09063	2x36 W	T26	Manyetik	2	4	115.00
12 436 002 001 09064	4x36 W	T26	Manyetik	2	2	235.00

Gövde : DKP Sac Boya: Elektrostatik toz Duy: Darbe ve ısıya dayanıklı PC. Balast: Alüminyum Sargılı Starter: Standart  
Reflektör: Alüminyum Çerçeve: DKP Sac Kablo: Standart

## SIVA ALTI PRİZMATİK LENSLİ ARMATÜRLER



Kod	Cinsi	Ampül	Balast	Amb. Ad.	Koli Ad.	Fiyat (₺)
12 118 002 001 09116	1x18 W	T26	Manyetik	2	10	79.00
12 218 002 001 09117	2x18 W	T26	Manyetik	2	10	81.00
12 418 002 001 09118	4x18 W	T26	Manyetik	2	6	119.00
12 136 002 001 09119	1x36 W	T26	Manyetik	2	4	121.00
12 236 002 001 09120	2x36 W	T26	Manyetik	2	4	125.00
12 436 002 001 09121	4x36 W	T26	Manyetik	2	2	269.00

Gövde : DKP Sac Boya: Elektrostatik toz Duy: Darbe ve ısıya dayanıklı PC. Balast: Alüminyum Sargılı Starter: Standart  
Lens: Akrilik prizmatik Çerçeve: Alüminyum ekstrüzyon Kablo: Standart

## SIVA ALTI OPAL LENSLİ ARMATÜRLER

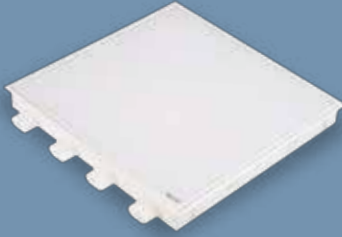

Kod	Cinsi	Ampül	Balast	Amb. Ad.	Koli Ad.	Fiyat (₺)
12 118 002 001 09093	1x18 W	T26	Manyetik	2	10	91.00
12 218 002 001 09094	2x18 W	T26	Manyetik	2	10	93.00
12 418 002 001 09095	4x18 W	T26	Manyetik	2	6	131.00
12 136 002 001 09096	1x36 W	T26	Manyetik	2	4	133.00
12 236 002 001 09097	2x36 W	T26	Manyetik	2	4	137.00
12 436 002 001 09098	4x36 W	T26	Manyetik	2	2	286.00

Gövde: DKP Sac Boya: Elektrostatik toz Duy: Darbe ve ısıya dayanıklı PC. Balast: Alüminyum Sargılı Starter: Standart  
Lens: Akrilik opal Çerçeve: Alüminyum ekstrüzyon Kablo: Standart

## SIVA ALTI LOUVER PETEKLİ ARMATÜRLER

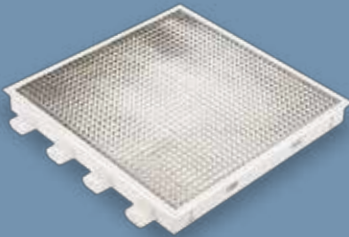

Kod	Cinsi	Ampül	Balast	Amb. Ad.	Koli Ad.	Fiyat (₺)
12 118 002 001 09140	1x18 W	T26	Manyetik	2	10	127.00
12 218 002 001 09141	2x18 W	T26	Manyetik	2	10	129.00
12 418 002 001 09142	4x18 W	T26	Manyetik	2	6	219.00
12 136 002 001 09143	1x36 W	T26	Manyetik	2	4	221.00
12 236 002 001 09144	2x36 W	T26	Manyetik	2	4	224.00
12 436 002 001 09145	4x36 W	T26	Manyetik	2	2	442.00

Gövde: DKP Sac Boya: Elektrostatik toz Duy: Darbe ve ısıya dayanıklı PC. Balast: Alüminyum Sargılı Starter: Standart  
Lens: Akrilik esaslı parabolik ayna petekli Çerçeve: DKP Sac Kablo: Standart

## T8 SIVA ALTI PERFORE KAPAKLI ARMATÜRLER



Kod	Cinsi	Ampül	Balast	Amb. Ad.	Koli Ad.	Fiyat (₺)
12 218 002 001 09073	2x18 W	T26	Manyetik	2	10	125.00
12 418 002 001 09074	4x18 W	T26	Manyetik	2	6	171.00
12 236 002 001 09075	2x36 W	T26	Manyetik	2	4	183.00
12 436 002 001 09076	4x36 W	T26	Manyetik	2	2	332.00

Gövde: DKP Sac Boya: Elektrostatik toz Duy: Darbe ve ısıya dayanıklı PC. Balast: Alüminyum Sargılı Starter: Standart  
Reflektör: Alüminyum Kablo: Standart

## SIVA ÜSTÜ ÇİFT PARABOLİK ARMATÜRLER

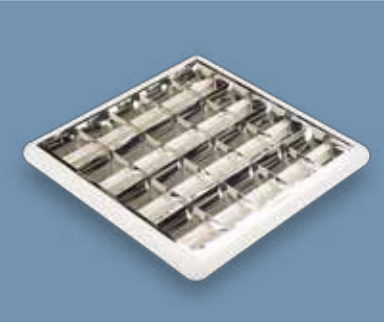

Kod	Cinsi	Ampül	Balast	Amb. Ad.	Koli Ad.	Fiyat (₺)
22 118 002 001 09041	1x18 W	T26	Manyetik	2	10	79.00
22 218 002 001 09042	2x18 W	T26	Manyetik	2	10	81.00
22 418 002 001 09043	4x18 W	T26	Manyetik	2	6	113.00
22 136 002 001 09044	1x36 W	T26	Manyetik	2	4	115.00
22 236 002 001 09045	2x36 W	T26	Manyetik	2	4	119.00
22 436 002 001 09046	4x36 W	T26	Manyetik	2	2	243.00

Gövde: DKP Sac Boya: Elektrostatik toz Duy: Darbe ve ısıya dayanıklı PC. Balast: Alüminyum Sargılı Starter: Standart  
Reflektör: Alüminyum Çerçeve: DKP Sac Kablo: Standart

## SIVA ÜSTÜ PRİZMATİK LENSLİ ARMATÜRLER



Kod	Cinsi	Ampül	Balast	Amb. Ad.	Koli Ad.	Fiyat (₺)
22 118 002 001 09105	1x18 W	T26	Manyetik	2	10	83.00
22 218 002 001 09106	2x18 W	T26	Manyetik	2	10	85.00
22 418 002 001 09107	4x18 W	T26	Manyetik	2	6	123.00
22 136 002 001 09108	1x36 W	T26	Manyetik	2	4	125.00
22 236 002 001 09152	2x36 W	T26	Manyetik	2	4	129.00
22 436 002 001 09109	4x36 W	T26	Manyetik	2	2	277.00

Gövde: DKP Sac Boya: Elektrostatik toz Duy: Darbe ve ısıya dayanıklı PC. Balast: Alüminyum Sargılı Starter: Standart  
Lens: Akrilik prizmatik Çerçeve: Alüminyum ekstrüzyon Kablo: Standart

## SIVA ÜSTÜ OPAL LENSLİ ARMATÜRLER



Kod	Cinsi	Ampül	Balast	Amb. Ad.	Koli Ad.	Fiyat (₺)
22 118 002 001 09110	1x18 W	T26	Manyetik	2	10	95.00
22 218 002 001 09111	2x18 W	T26	Manyetik	2	10	97.00
22 418 002 001 09112	4x18 W	T26	Manyetik	2	6	135.00
22 136 002 001 09113	1x36 W	T26	Manyetik	2	4	137.00
22 236 002 001 09114	2x36 W	T26	Manyetik	2	4	141.00
22 436 002 001 09115	4x36 W	T26	Manyetik	2	2	294.00

Gövde: DKP Sac Boya: Elektrostatik toz Duy: Darbe ve ısıya dayanıklı PC. Balast: Alüminyum Sargılı Starter: Standart  
Lens: Akrilik opal Çerçeve: Alüminyum ekstrüzyon Kablo: Standart

## SIVA ÜSTÜ LOUVER PETEKLİ ARMATÜRLER

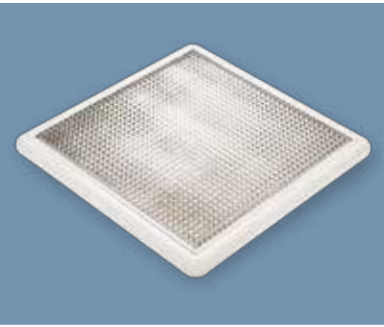

Kod	Cinsi	Ampül	Balast	Amb. Ad.	Koli Ad.	Fiyat (₺)
22 118 002 001 09128	1x18 W	T26	Manyetik	2	10	131.00
22 218 002 001 09129	2x18 W	T26	Manyetik	2	10	133.00
22 418 002 001 09130	4x18 W	T26	Manyetik	2	6	223.00
22 136 002 001 09131	1x36 W	T26	Manyetik	2	4	225.00
22 236 002 001 09132	2x36 W	T26	Manyetik	2	4	228.00
22 436 002 001 09133	4x36 W	T26	Manyetik	2	2	450.00

Gövde: DKP Sac Boya: Elektrostatik toz Duy: Darbe ve ısıya dayanıklı PC. Balast: Alüminyum Sargılı Starter: Standart  
Lens: Akrilik esaslı parabolik ayna petekli Çerçeve: DKP Sac Kablo: Standart

## T8 SIVA ÜSTÜ PERFORE KAPAKLI ARMATÜRLER



Kod	Cinsi	Ampül	Balast	Amb. Ad.	Koli Ad.	Fiyat (₺)
22 218 002 001 09065	2x18 W	T26	Manyetik	2	10	129.00
22 418 002 001 09066	4x18 W	T26	Manyetik	2	6	175.00
22 236 002 001 09067	2x36 W	T26	Manyetik	2	4	187.00
22 436 002 001 09068	4x36 W	T26	Manyetik	2	2	340.00

Gövde: DKP Sac Boya: Elektrostatik toz Duy: Darbe ve ısıya dayanıklı PC. Balast: Alüminyum Sargılı Starter: Standart  
Reflektör: Alüminyum Kablo: Standart

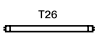

**SIVA ALTI ÇİFT PARABOLİK ARMATÜRLER**

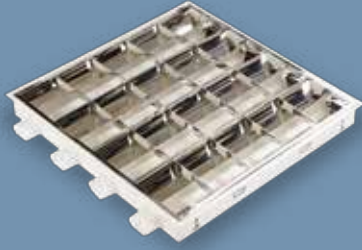

Kod	Cinsi	Ampül	Balast	Amb. Ad.	Koli Ad.	Fiyat (₺)
12 118 003 001 09053	1x18 W	T26	Elektronik	2	10	<b>109.00</b>
12 218 003 001 09054	2x18 W	T26	Elektronik	2	10	<b>111.00</b>
12 418 003 001 09055	4x18 W	T26	Elektronik	2	6	<b>132.00</b>
12 136 003 001 09056	1x36 W	T26	Elektronik	2	4	<b>134.00</b>
12 236 003 001 09057	2x36 W	T26	Elektronik	2	4	<b>137.00</b>
12 436 003 001 09058	4x36 W	T26	Elektronik	2	2	<b>289.00</b>

Gövde: DKP Sac Boya: Elektrostatik toz Duy: Darbe ve ısıya dayanıklı PC. Balast: Elektronik (30.000) saat ömürlü  
Reflektör: Alüminyum Kablo: Standart **\*\*30.000 saat ömürlü balastlarda sensör kullanılmaz**

**SIVA ALTI PRİZMATİK LENSLİ ARMATÜRLER**



Kod	Cinsi	Ampül	Balast	Amb. Ad.	Koli Ad.	Fiyat (₺)
12 118 003 001 09122	1x18 W	T26	Elektronik	2	10	<b>119.00</b>
12 218 003 001 09123	2x18 W	T26	Elektronik	2	10	<b>121.00</b>
12 418 003 001 09124	4x18 W	T26	Elektronik	2	6	<b>149.00</b>
12 136 003 001 09125	1x36 W	T26	Elektronik	2	4	<b>152.00</b>
12 236 003 001 09126	2x36 W	T26	Elektronik	2	4	<b>155.00</b>
12 436 003 001 09127	4x36 W	T26	Elektronik	2	2	<b>345.00</b>

Gövde: DKP Sac Boya: Elektrostatik toz Duy: Darbe ve ısıya dayanıklı PC. Balast: Elektronik (30.000) saat ömürlü  
Lens: Akrilik prizmatik Çerçeve: Alüminyum ekstrüzyon Kablo: Standart **\*\*30.000 saat ömürlü balastlarda sensör kullanılmaz**

**SIVA ALTI OPAL LENSLİ ARMATÜRLER**

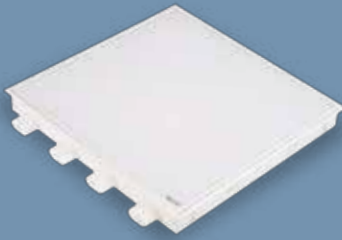

Kod	Cinsi	Ampül	Balast	Amb. Ad.	Koli Ad.	Fiyat (₺)
12 118 003 001 09099	1x18 W	T26	Elektronik	2	10	<b>129.00</b>
12 218 003 001 09100	2x18 W	T26	Elektronik	2	10	<b>131.00</b>
12 418 003 001 09101	4x18 W	T26	Elektronik	2	6	<b>159.00</b>
12 136 003 001 09102	1x36 W	T26	Elektronik	2	4	<b>162.00</b>
12 236 003 001 09103	2x36 W	T26	Elektronik	2	4	<b>165.00</b>
12 436 003 001 09104	4x36 W	T26	Elektronik	2	2	<b>359.00</b>

Gövde: DKP Sac Boya: Elektrostatik toz Duy: Darbe ve ısıya dayanıklı PC. Balast: Elektronik (30.000) saat ömürlü  
Lens: Akrilik opal Çerçeve: Alüminyum ekstrüzyon Kablo: Standart **\*\*30.000 saat ömürlü balastlarda sensör kullanılmaz**

**SIVA ALTI LOUVER PETEKLİ ARMATÜRLER**

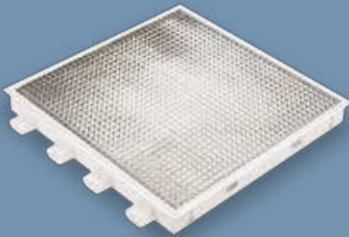

Kod	Cinsi	Ampül	Balast	Amb. Ad.	Koli Ad.	Fiyat (₺)
12 118 003 001 09146	1x18 W	T26	Elektronik	2	10	<b>169.00</b>
12 218 003 001 09147	2x18 W	T26	Elektronik	2	10	<b>171.00</b>
12 418 003 001 09148	4x18 W	T26	Elektronik	2	6	<b>249.00</b>
12 136 003 001 09149	1x36 W	T26	Elektronik	2	4	<b>252.00</b>
12 236 003 001 09150	2x36 W	T26	Elektronik	2	4	<b>255.00</b>
12 436 003 001 09151	4x36 W	T26	Elektronik	2	2	<b>517.00</b>

Gövde: DKP Sac Boya: Elektrostatik toz Duy: Darbe ve ısıya dayanıklı PC. Balast: Elektronik (30.000) saat ömürlü  
Lens: Akrilik esaslı parabolik ayna petekli Çerçeve: DKP Sac Kablo: Standart **\*\*30.000 saat ömürlü balastlarda sensör kullanılmaz**

**T8 SIVA ALTI PERFORE KAPAKLI ARMATÜRLER**



Kod	Cinsi	Ampül	Balast	Amb. Ad.	Koli Ad.	Fiyat (₺)
12 218 003 001 09077	2x18 W	T26	Elektronik	2	10	<b>171.00</b>
12 418 003 001 09078	4x18 W	T26	Elektronik	2	6	<b>213.00</b>
12 236 003 001 09079	2x36 W	T26	Elektronik	2	4	<b>223.00</b>
12 436 003 001 09080	4x36 W	T26	Elektronik	2	2	<b>415.00</b>

Gövde: DKP Sac Boya: Elektrostatik toz Duy: Darbe ve ısıya dayanıklı PC. Balast: Elektronik (30.000) saat ömürlü  
Reflektör: Alüminyum **\*\*30.000 saat ömürlü balastlarda sensör kullanılmaz**



## SIVA ÜSTÜ ÇİFT PARABOLİK ARMATÜRLER

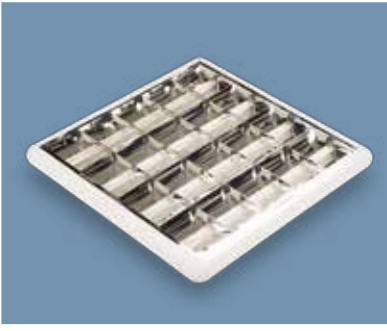

Kod	Cinsi	Ampül	Balast	Amb. Ad.	Koli Ad.	Fiyat (₺)
22 118 003 001 09047	1x18 W	T26	Elektronik	2	10	113.00
22 218 003 001 09048	2x18 W	T26	Elektronik	2	10	115.00
22 418 003 001 09049	4x18 W	T26	Elektronik	2	6	136.00
22 136 003 001 09050	1x36 W	T26	Elektronik	2	4	138.00
22 236 003 001 09051	2x36 W	T26	Elektronik	2	4	141.00
22 436 003 001 09052	4x36 W	T26	Elektronik	2	2	297.00

Gövde: DKP Sac Boya: Elektrostatik toz Duy: Darbe ve ısıya dayanıklı PC. Balast: Elektronik (30.000) saat ömürlü  
Reflektör: Alüminyum Kablo: Standart

\*\*30.000 saat ömürlü balastlarda sensör kullanılmaz

## SIVA ÜSTÜ PRİZMATİK LENSLİ ARMATÜRLER



Kod	Cinsi	Ampül	Balast	Amb. Ad.	Koli Ad.	Fiyat (₺)
22 118 003 001 09153	1x18 W	T26	Elektronik	2	10	123.00
22 218 003 001 09154	2x18 W	T26	Elektronik	2	10	125.00
22 418 003 001 09155	4x18 W	T26	Elektronik	2	6	153.00
22 136 003 001 09156	1x36 W	T26	Elektronik	2	4	156.00
22 236 003 001 09157	2x36 W	T26	Elektronik	2	4	159.00
22 436 003 001 09158	4x36 W	T26	Elektronik	2	2	353.00

Gövde: DKP Sac Boya: Elektrostatik toz Duy: Darbe ve ısıya dayanıklı PC. Balast: Elektronik (30.000) saat ömürlü  
Lens: Akrilik prizmatik Çerçeve: Alüminyum ekstrüzyon Kablo: Standart

\*\*30.000 saat ömürlü balastlarda sensör kullanılmaz

## SIVA ÜSTÜ OPAL LENSLİ ARMATÜRLER



Kod	Cinsi	Ampül	Balast	Amb. Ad.	Koli Ad.	Fiyat (₺)
22 118 003 001 09087	1x18 W	T26	Elektronik	2	10	133.00
22 218 003 001 09088	2x18 W	T26	Elektronik	2	10	135.00
22 418 003 001 09089	4x18 W	T26	Elektronik	2	6	163.00
22 136 003 001 09090	1x36 W	T26	Elektronik	2	4	166.00
22 236 003 001 09091	2x36 W	T26	Elektronik	2	4	169.00
22 436 003 001 09092	4x36 W	T26	Elektronik	2	2	367.00

Gövde: DKP Sac Boya: Elektrostatik toz Duy: Darbe ve ısıya dayanıklı PC. Balast: Elektronik (30.000) saat ömürlü  
Lens: Akrilik opal Çerçeve: Alüminyum ekstrüzyon Kablo: Standart

\*\*30.000 saat ömürlü balastlarda sensör kullanılmaz

## SIVA ÜSTÜ LOUVER PETEKLİ ARMATÜRLER

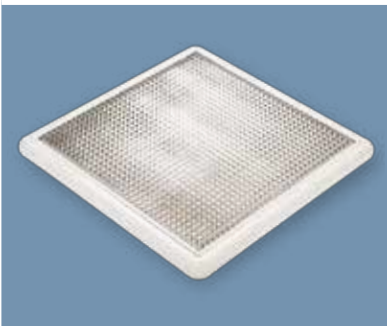

Kod	Cinsi	Ampül	Balast	Amb. Ad.	Koli Ad.	Fiyat (₺)
22 118 003 001 09134	1x18 W	T26	Elektronik	2	10	173.00
22 218 003 001 09135	2x18 W	T26	Elektronik	2	10	175.00
22 418 003 001 09136	4x18 W	T26	Elektronik	2	6	253.00
22 136 003 001 09137	1x36 W	T26	Elektronik	2	4	256.00
22 236 003 001 09138	2x36 W	T26	Elektronik	2	4	259.00
22 436 003 001 09139	4x36 W	T26	Elektronik	2	2	525.00

Gövde: DKP Sac Boya: Elektrostatik toz Duy: Darbe ve ısıya dayanıklı PC. Balast: Elektronik (30.000) saat ömürlü  
Lens: Akrilik esaslı parabolik ayna petekli Çerçeve: DKP Sac Kablo: Standart

\*\*30.000 saat ömürlü balastlarda sensör kullanılmaz

## T8 SIVA ÜSTÜ PERFORE KAPAKLI ARMATÜRLER

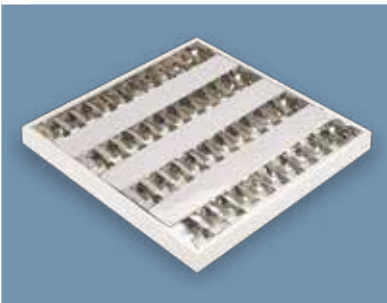

Kod	Cinsi	Ampül	Balast	Amb. Ad.	Koli Ad.	Fiyat (₺)
22 218 003 001 09069	2x18 W	T26	Elektronik	2	10	175.00
22 418 003 001 09070	4x18 W	T26	Elektronik	2	6	217.00
22 236 003 001 09071	2x36 W	T26	Elektronik	2	4	227.00
22 436 003 001 09072	4x36 W	T26	Elektronik	2	2	423.00

Gövde: DKP Sac Boya: Elektrostatik toz Duy: Darbe ve ısıya dayanıklı PC. Balast: Elektronik (30.000) saat ömürlü  
Reflektör: Alüminyum

\*\*30.000 saat ömürlü balastlarda sensör kullanılmaz



## EKO MODELİ T8 TMS ARMATÜRLER (MANYETİK BALASTLI)

Kod	GÜÇ	Ampül	Balast	Amb. Ad.	Koli Ad.	Fiyat (₺)
22 118 002 001 09159	1x18 W	T26	Manyetik	6	6	34.00
22 218 002 001 09160	2x18 W	T26	Manyetik	6	6	37.00
22 136 002 001 09161	1x36 W	T26	Manyetik	6	6	39.50
22 236 002 001 09162	2x36 W	T26	Manyetik	6	6	59.50
22 158 002 001 09163	1x58 W	T26	Manyetik	6	6	63.00
22 258 002 001 09164	2x58 W	T26	Manyetik	6	6	98.00

Gövde: DKP Sac Boya: Elektrostatik toz Duy: Darbe ve ısıya dayanıklı Balast: Manyetik Alüminyum  
Kablo: Standart Starter: Standart

## EKO MODELİ T8 ETANJ DUYLU TMS ARMATÜRLER (MANYETİK BALASTLI)

Kod	GÜÇ	Ampül	Balast	Amb. Ad.	Koli Ad.	Fiyat (₺)
22 118 002 001 09172	1x18 W	T26	Manyetik	6	6	51.00
22 218 002 001 09173	2x18 W	T26	Manyetik	6	6	67.00
22 136 002 001 09174	1x36 W	T26	Manyetik	6	6	67.00
22 236 002 001 09175	2x36 W	T26	Manyetik	6	6	91.00
22 158 002 001 09176	1x58 W	T26	Manyetik	6	6	86.00
22 258 002 001 09177	2x58 W	T26	Manyetik	6	6	132.00

Gövde: DKP Sac Boya: Elektrostatik toz Duy: Darbe ve ısıya dayanıklı Balast: Manyetik Alüminyum  
Kablo: Standart Starter: Standart

## EKO MODELİ U1 TİP T8 ETANJ ARMATÜRLER (MANYETİK BALASTLI)

Kod	GÜÇ	Ampül	Balast	Amb. Ad.	Koli Ad.	Fiyat (₺)
26 118 002 003 01293	1x18 W	T26	Manyetik	2	12	55.00
26 218 002 003 01294	2x18 W	T26	Manyetik	2	12	62.00
26 136 002 003 01295	1x36 W	T26	Manyetik	2	8	69.00
26 236 002 003 01296	2x36 W	T26	Manyetik	2	8	87.00

Gövde: ABS Sac Boya: Elektrostatik toz Duy: Darbe ve ısıya dayanıklı Balast: Manyetik Alüminyum  
Kapak: ASY Kablo: Standart Starter: Standart

## EKO MODELİ T1 TİP T8 TSC OKUL ARMATÜRLERİ (MANYETİK BALASTLI)

Kod	GÜÇ	Ampül	Balast	Amb. Ad.	Koli Ad.	Fiyat (₺)
24 118 002 001 03300	1x18 W	T26	Manyetik	2	12	57.00
24 218 002 001 03301	2x18 W	T26	Manyetik	2	12	67.00
24 136 002 001 03302	1x36 W	T26	Manyetik	2	8	88.00
24 236 002 001 03303	2x36 W	T26	Manyetik	2	8	98.00

Gövde: DKP Sac Boya: Elektrostatik toz Duy: Darbe ve ısıya dayanıklı Balast: Manyetik Alüminyum  
Kapak: ASY Kablo: Standart Starter: Standart

## 5W EKO MODEL COB LED ARMATÜRLER (İTHAL)

Kod	Güç	Kasa Rengi	Renk	Lümen	Amb. Ad.	Koli Ad.	Fiyat (USD)
12 005 001 400 09037	5 W	Beyaz	4000K	400	1	100	5.50
12 005 001 650 09038	5 W	Beyaz	6500K	400	1	100	5.50
12 005 001 400 09039	5 W	Nikel	4000K	400	1	100	5.50
12 005 001 650 09040	5 W	Nikel	6500K	400	1	100	5.50



## EKO MODELİ T8 TMS ARMATÜRLER (ELEKTRONİK BALASTLI)

Kod	GÜÇ	Ampül	Balast	Amb. Ad.	Koli Ad.	Fiyat (₺)
22 118 003 001 09165	1x18 W	T26	Elektronik	6	6	59.50
22 218 003 001 09166	2x18 W	T26	Elektronik	6	6	68.00
22 136 003 001 09167	1x36 W	T26	Elektronik	6	6	69.50
22 236 003 001 09168	2x36 W	T26	Elektronik	6	6	79.00
22 158 003 001 09169	1x58 W	T26	Elektronik	6	6	69.50
22 258 003 001 09170	2x58 W	T26	Elektronik	6	6	94.00

Gövde: DKP Sac Boya: Elektrostatik toz Duy: Darbe ve ısıya dayanıklı Balast: Osram Elektronik (30.000) saat ömürlü  
Kablo: Standart **\*\*30.000 saat ömürlü balastlarda sensör kullanılmaz**

## EKO MODELİ T8 ETANJ DUYLU TMS ARMATÜRLER (ELEKTRONİK BALASTLI)

Kod	GÜÇ	Ampül	Balast	Amb. Ad.	Koli Ad.	Fiyat (₺)
22 118 003 001 09178	1x18 W	T26	Elektronik	6	6	79.50
22 218 003 001 09179	2x18 W	T26	Elektronik	6	6	99.00
22 136 003 001 09180	1x36 W	T26	Elektronik	6	6	99.00
22 236 003 001 09181	2x36 W	T26	Elektronik	6	6	114.00
22 158 003 001 09182	1x58 W	T26	Elektronik	6	6	102.00
22 258 003 001 09183	2x58 W	T26	Elektronik	6	6	137.00

Gövde: DKP Sac Boya: Elektrostatik toz Duy: Darbe ve ısıya dayanıklı Balast: Osram Elektronik (30.000) saat ömürlü  
Kablo: Standart **\*\*30.000 saat ömürlü balastlarda sensör kullanılmaz**

## EKO MODELİ U1 TİP T8 ETANJ ARMATÜRLER (ELEKTRONİK BALASTLI) İTHAL ÇİN

Kod	GÜÇ	Ampül	Balast	Amb. Ad.	Koli Ad.	Fiyat (₺)
26 118 003 003 09184	1x18 W	T26	Elektronik	2	12	48.50
26 218 003 003 09185	2x18 W	T26	Elektronik	2	12	59.90
26 136 003 003 09186	1x36 W	T26	Elektronik	2	8	65.50
26 236 003 003 09187	2x36 W	T26	Elektronik	2	8	79.90

Gövde: ABS Sac Boya: Elektrostatik toz Duy: Darbe ve ısıya dayanıklı Balast: Elektronik (ithal)  
Kapak: ASY Kablo: Standart **\*\*İthal balastlarda sensör kullanılmaz**

## EKO MODELİ U1 TİP T8 ETANJ ARMATÜRLER (ELEKTRONİK BALASTLI)

Kod	GÜÇ	Ampül	Balast	Amb. Ad.	Koli Ad.	Fiyat (₺)
26 118 003 003 01299	1x18 W	T26	Elektronik	2	12	85.00
26 218 003 003 01300	2x18 W	T26	Elektronik	2	12	98.00
26 136 003 003 01301	1x36 W	T26	Elektronik	2	8	99.00
26 236 003 003 01302	2x36 W	T26	Elektronik	2	8	109.00

Gövde: DKP Sac Boya: Elektrostatik toz Duy: Darbe ve ısıya dayanıklı Balast: Osram Elektronik (30.000) saat ömürlü  
Kablo: Standart **\*\*30.000 saat ömürlü balastlarda sensör kullanılmaz**

## EKO MODELİ T1 TİP T8 TSC OKUL ARMATÜRLERİ (ELEKTRONİK BALASTLI)

Kod	GÜÇ	Ampül	Balast	Amb. Ad.	Koli Ad.	Fiyat (₺)
24 118 003 001 03304	1x18 W	T26	Elektronik	2	12	95.00
24 218 003 001 03305	2x18 W	T26	Elektronik	2	12	109.00
24 136 003 001 03306	1x36 W	T26	Elektronik	2	8	119.00
24 236 003 001 03307	2x36 W	T26	Elektronik	2	8	119.00

Gövde: DKP Sac Boya: Elektrostatik toz Duy: Darbe ve ısıya dayanıklı Balast: Osram Elektronik (30.000) saat ömürlü  
Kapak: ASY Kablo: Standart **\*\*30.000 saat ömürlü balastlarda sensör kullanılmaz**



## EKO T5 SIVA ALTI PERFORE KAPAKLI ARMATÜRLER (ELEKTRONİK BALASTLI)

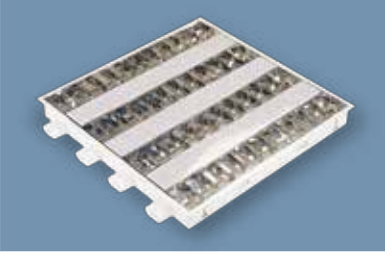

Kod	Cinsi	Ampül	Balast	Amb. Ad.	Koli Ad.	Fiyat (₺)
12 414 003 001 09001	4x14 W	T16	Elektronik	2	6	195.00

Gövde: DKP Sac Boya: Elektrostatik toz Duy: Darbe ve ısıya dayanıklı PC. Balast: Elektronik  
Reflektör: Alüminyum Kablo: Standart

## EKO T5 SIVA ÜSTÜ PERFORE KAPAKLI ARMATÜRLER (ELEKTRONİK BALASTLI)

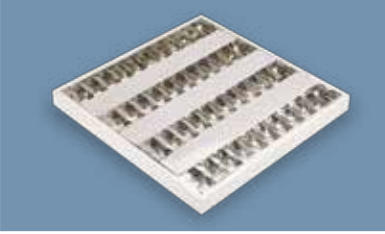

Kod	Cinsi	Ampül	Balast	Amb. Ad.	Koli Ad.	Fiyat (₺)
22 414 003 001 09007	4x14 W	T16	Elektronik	2	6	199.00

Gövde: DKP Sac Boya: Elektrostatik toz Duy: Darbe ve ısıya dayanıklı PC. Balast: Elektronik  
Reflektör: Alüminyum Kablo: Standart

## EKO T5 P1 TMS ARMATÜRLER (ELEKTRONİK BALASTLI)



Kod	GÜÇ	Ampül	Balast	Amb. Ad.	Koli Ad.	Fiyat (₺)
22 114 003 001 09019	1x14-24 W	T16	Elektronik	-	6	79.00
22 214 003 001 09020	2x14-24 W	T16	Elektronik	-	6	86.00
22 121 003 001 09021	1x21-39 W	T16	Elektronik	-	6	87.50
22 221 003 001 09022	2x21-39 W	T16	Elektronik	-	6	97.00
22 128 003 001 09023	1x28-54 W	T16	Elektronik	-	6	88.00
22 228 003 001 09024	2x28-54 W	T16	Elektronik	-	6	98.00
22 135 003 001 09025	1x35-49 W	T16	Elektronik	-	20	102.00
22 235 003 001 09026	2x35-49 W	T16	Elektronik	-	20	119.50
22 180 003 001 09027	1x80 W	T16	Elektronik	-	20	106.00
22 280 003 001 09028	2x80 W	T16	Elektronik	-	20	137.00

Gövde: DKP Sac Boya: Elektrostatik toz Duy: Darbe ve ısıya dayanıklı Balast: Osram veya Tridonic  
Kablo: Standart

\*\*30.000 saat ömürlü balastlarda sensör kullanılmaz

## EKO T5 YÜKSEK TAVAN ARMATÜRLERİ (ELEKTRONİK BALASTLI) IP65



Kod	GÜÇ	Ampül	Balast	Amb. Ad.	Koli Ad.	Fiyat (₺)
26 228 003 003 09029	2x28 W	T16	Elektronik	1	2	309.00
26 235 003 003 09030	2x35 W	T16	Elektronik	1	2	355.00
26 254 003 003 09031	2x54 W	T16	Elektronik	1	2	309.00
26 280 003 003 09032	2x80 W	T16	Elektronik	1	2	379.00
26 428 003 003 09033	4x28 W	T16	Elektronik	1	1	494.00
26 435 003 003 09034	4x35 W	T16	Elektronik	1	1	597.00
26 454 003 003 09035	4x54 W	T16	Elektronik	1	1	493.00
26 480 003 003 09036	4x80 W	T16	Elektronik	1	1	655.00

Gövde: DKP Sac Boya: Elektrostatik toz Duy: Darbe ve ısıya dayanıklı Balast: Osram veya Tridonic  
Cam: Tamperli Kablo: Standart Reflektör: Alüminyum

\*\*30.000 saat ömürlü balastlarda sensör kullanılmaz

## EKO CADDE VE SOKAK ARMATÜRÜ



Kod	GÜÇ	Ürün Adı	Amb. Ad.	Koli Ad.	Fiyat (₺)
46 160 004 003 01271	160 W	Civa buharlı (balastsız)	1	6	57.00
46 125 005 003 01272	125 W	Civa buharlı (balastlı)	1	6	87.00
46 250 004 003 01273	250 W	Civa buharlı (balastsız)	1	3	126.00
90 000 000 000 1333	-	Konsol boru	-	30	10.50





**İŞILDAR**<sup>®</sup>  
LIGHTING SYSTEM

Sıva Altı Ofis Armatürleri Eko Model  
Sıva Üstü Ofis Armatürleri Eko Model  
Eko Modeli Bant Armatürleri  
Eko Model CLIP-IN Ofis Armatürleri

**EKO MODEL CLIP-IN OFİS ARMATÜRLERİ**

**02**

## EKO MODEL CLIP-IN ÇİFT PARABOLİK ARMATÜRLER

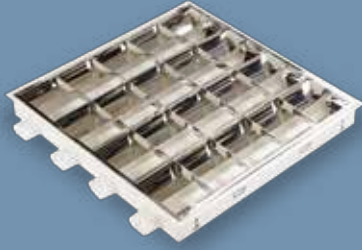

Kod	Cinsi	Ampül	Balast	Amb. Ad.	Koli Ad.	Fiyat (₺)
12 118 002 001 09188	1x18 W	T26	Manyetik	2	8	91.00
12 218 002 001 09189	2x18 W	T26	Manyetik	2	8	93.00
12 418 002 001 09190	4x18 W	T26	Manyetik	2	6	125.00
12 136 002 001 09191	1x36 W	T26	Manyetik	2	2	127.00
12 236 002 001 09192	2x36 W	T26	Manyetik	2	2	131.00
12 436 002 001 09193	4x36 W	T26	Manyetik	2	2	251.00

Gövde : DKP Sac Boya: Elektrostatik toz Duy: Darbe ve ısıya dayanıklı PC. Balast: Alüminyum Sargılı Starter: Standart  
Reflektör : Alüminyum Kablo: Standart

## EKO MODEL CLIP-IN PRİZMATİK LENSİ ARMATÜRLER



Kod	Cinsi	Ampül	Balast	Amb. Ad.	Koli Ad.	Fiyat (₺)
12 118 002 001 09223	1x18 W	T26	Manyetik	2	8	95.00
12 218 002 001 09224	2x18 W	T26	Manyetik	2	8	97.00
12 418 002 001 09225	4x18 W	T26	Manyetik	2	6	135.00
12 136 002 001 09226	1x36 W	T26	Manyetik	2	2	137.00
12 236 002 001 09227	2x36 W	T26	Manyetik	2	2	141.00
12 436 002 001 09228	4x36 W	T26	Manyetik	2	2	285.00

Gövde: DKP Sac Boya: Elektrostatik toz Duy: Darbe ve ısıya dayanıklı PC. Balast: Alüminyum Sargılı Starter: Standart  
Lens: Polistren prizmatik Çerçeve: Alüminyum ekstrüzyon Kablo: Standart

## EKO MODEL CLIP-IN OPAL LENSİ ARMATÜRLER

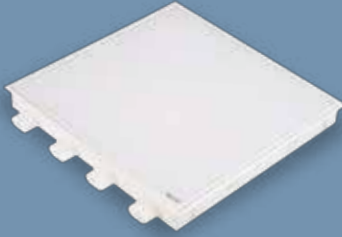

Kod	Cinsi	Ampül	Balast	Amb. Ad.	Koli Ad.	Fiyat (₺)
12 118 002 001 09199	1x18 W	T26	Manyetik	2	8	107.00
12 218 002 001 09200	2x18 W	T26	Manyetik	2	8	109.00
12 418 002 001 09201	4x18 W	T26	Manyetik	2	6	147.00
12 136 002 001 09202	1x36 W	T26	Manyetik	2	2	149.00
12 236 002 001 09203	2x36 W	T26	Manyetik	2	2	153.00
12 436 002 001 09204	4x36 W	T26	Manyetik	2	2	302.00

Gövde: DKP Sac Boya: Elektrostatik toz Duy: Darbe ve ısıya dayanıklı PC. Balast: Alüminyum Sargılı Starter: Standart  
Lens: Polistren opal Çerçeve: Alüminyum ekstrüzyon Kablo: Standart

## EKO MODEL CLIP-IN LOUVER PETEKLİ ARMATÜRLER

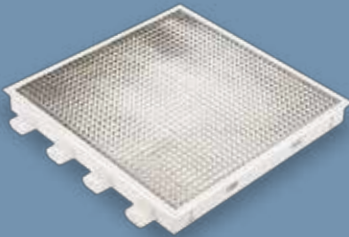

Kod	Cinsi	Ampül	Balast	Amb. Ad.	Koli Ad.	Fiyat (₺)
12 118 002 001 09211	1x18 W	T26	Manyetik	2	8	143.00
12 218 002 001 09212	2x18 W	T26	Manyetik	2	8	145.00
12 418 002 001 09213	4x18 W	T26	Manyetik	2	6	235.00
12 136 002 001 09214	1x36 W	T26	Manyetik	2	2	237.00
12 236 002 001 09215	2x36 W	T26	Manyetik	2	2	239.00
12 436 002 001 09216	4x36 W	T26	Manyetik	2	2	458.00

Gövde: DKP Sac Boya: Elektrostatik toz Duy: Darbe ve ısıya dayanıklı PC. Balast: Alüminyum Sargılı Starter: Standart  
Lens: Parabolik ayna petekli Çerçeve: DKP Sac Kablo: Standart

## EKO MODEL T8 CLIP-IN PERFORE KAPAKLI ARMATÜRLER



Kod	Cinsi	Ampül	Balast	Amb. Ad.	Koli Ad.	Fiyat (₺)
12 218 002 001 09235	2x18 W	T26	Manyetik	2	8	141.00
12 418 002 001 09236	4x18 W	T26	Manyetik	2	6	187.00
12 236 002 001 09237	2x36 W	T26	Manyetik	2	2	199.00
12 436 002 001 09238	4x36 W	T26	Manyetik	2	2	348.00

Gövde: DKP Sac Boya: Elektrostatik toz Duy: Darbe ve ısıya dayanıklı PC. Balast: Alüminyum Sargılı Starter: Standart  
Reflektör: Alüminyum Kablo: Standart Perfore: Serigrafı alüminyum

## EKO MODEL CLIP-IN ÇİFT PARABOLİK ARMATÜRLER

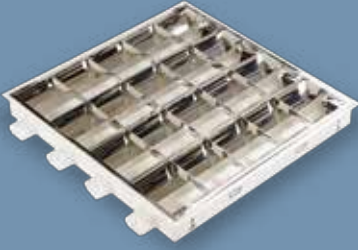

Kod	Cinsi	Ampül	Balast	Amb. Ad.	Koli Ad.	Fiyat (₺)
12 118 003 001 09194	1x18 W	T26	Elektronik	2	8	125.00
12 218 003 001 09195	2x18 W	T26	Elektronik	2	8	127.00
12 418 003 001 09196	4x18 W	T26	Elektronik	2	6	148.00
12 136 003 001 09197	1x36 W	T26	Elektronik	2	2	150.00
12 236 003 001 09198	2x36 W	T26	Elektronik	2	2	153.00
12 436 003 001 09243	4x36 W	T26	Elektronik	2	2	305.00

Gövde: DKP Sac Boya: Elektrostatik toz Duy: Darbe ve ısıya dayanıklı PC. Balast: Elektronik (30.000) saat ömürlü

Reflektör: Alüminyum Kablo: Standart

\*\*30.000 saat ömürlü balastlarda sensör kullanılmaz

## EKO MODEL CLIP-IN PRİZMATİK LENSİ ARMATÜRLER



Kod	Cinsi	Ampül	Balast	Amb. Ad.	Koli Ad.	Fiyat (₺)
12 118 003 001 09229	1x18 W	T26	Elektronik	2	8	135.00
12 218 003 001 09230	2x18 W	T26	Elektronik	2	8	137.00
12 418 003 001 09231	4x18 W	T26	Elektronik	2	6	165.00
12 136 003 001 09232	1x36 W	T26	Elektronik	2	2	168.00
12 236 003 001 09233	2x36 W	T26	Elektronik	2	2	171.00
12 436 003 001 09234	4x36 W	T26	Elektronik	2	2	361.00

Gövde: DKP Sac Boya: Elektrostatik toz Duy: Darbe ve ısıya dayanıklı PC. Balast: Elektronik (30.000) saat ömürlü

Lens: Polistren prizmatik Çerçeve: Alüminyum ekstrüzyon Kablo: Standart

\*\*30.000 saat ömürlü balastlarda sensör kullanılmaz

## EKO MODEL CLIP-IN OPAL LENSİ ARMATÜRLER

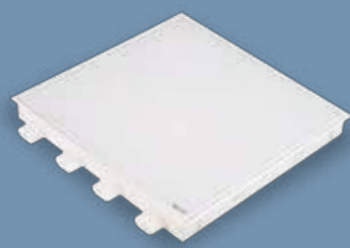

Kod	Cinsi	Ampül	Balast	Amb. Ad.	Koli Ad.	Fiyat (₺)
12 118 003 001 09205	1x18 W	T26	Elektronik	2	8	145.00
12 218 003 001 09206	2x18 W	T26	Elektronik	2	8	147.00
12 418 003 001 09207	4x18 W	T26	Elektronik	2	6	175.00
12 136 003 001 09208	1x36 W	T26	Elektronik	2	2	178.00
12 236 003 001 09209	2x36 W	T26	Elektronik	2	2	181.00
12 436 003 001 09210	4x36 W	T26	Elektronik	2	2	375.00

Gövde: DKP Sac Boya: Elektrostatik toz Duy: Darbe ve ısıya dayanıklı PC. Balast: Elektronik (30.000) saat ömürlü

Lens: Polistren opal Çerçeve: Alüminyum ekstrüzyon Kablo: Standart

\*\*30.000 saat ömürlü balastlarda sensör kullanılmaz

## EKO MODEL CLIP-IN LOUVER PETEKİ ARMATÜRLER

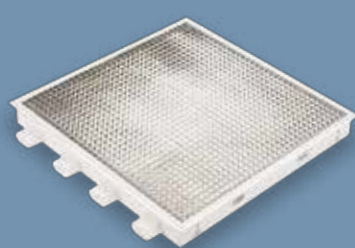

Kod	Cinsi	Ampül	Balast	Amb. Ad.	Koli Ad.	Fiyat (₺)
12 118 003 001 09217	1x18 W	T26	Elektronik	2	8	185.00
12 218 003 001 09218	2x18 W	T26	Elektronik	2	8	187.00
12 418 003 001 09219	4x18 W	T26	Elektronik	2	6	265.00
12 136 003 001 09220	1x36 W	T26	Elektronik	2	2	268.00
12 236 003 001 09221	2x36 W	T26	Elektronik	2	2	271.00
12 436 003 001 09222	4x36 W	T26	Elektronik	2	2	533.00

Gövde: DKP Sac Boya: Elektrostatik toz Duy: Darbe ve ısıya dayanıklı PC. Balast: Elektronik (30.000) saat ömürlü

Lens: Parabolik ayna petekli Çerçeve: DKP Sac Kablo: Standart

\*\*30.000 saat ömürlü balastlarda sensör kullanılmaz

## EKO MODEL T8 CLIP-IN PERFORE KAPAKLI ARMATÜRLER

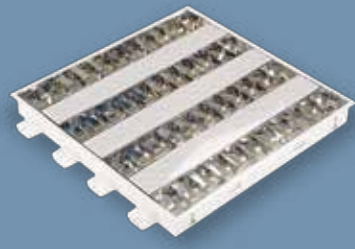

Kod	Cinsi	Ampül	Balast	Amb. Ad.	Koli Ad.	Fiyat (₺)
12 218 003 001 09239	2x18 W	T26	Elektronik	2	8	187.00
12 418 003 001 09240	4x18 W	T26	Elektronik	2	6	229.00
12 236 003 001 09241	2x36 W	T26	Elektronik	2	2	239.00
12 436 003 001 09242	4x36 W	T26	Elektronik	2	2	431.00

Gövde: DKP Sac Boya: Elektrostatik toz Duy: Darbe ve ısıya dayanıklı PC. Balast: Elektronik (30.000) saat ömürlü

Reflektör: Alüminyum Kablo: Standart Perfore: Serigrafli alüminyum

\*\*30.000 saat ömürlü balastlarda sensör kullanılmaz



Ürünlerde 1-3 saatlik acil kit uygulanabilir.

**EKO MODELİ POLİKARBON GÖVDE CLIP-IN E-27 DUYLU ARMATÜRLER 300X300X60**

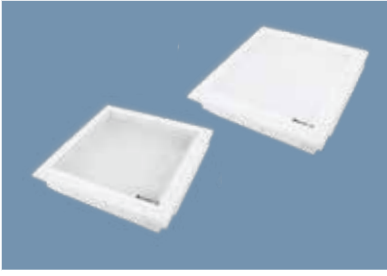

Kod	Cinsi	Amb. Ad.	Koli Ad.	Fiyat (₺)
12 225 000 001 07146	2xE-27 Duylu Prizmatik Lensli	4	24	<b>45.00</b>
12 225 000 001 07147	2xE-27 Duylu Opal Lensli	4	24	<b>49.00</b>

Bu ürünlerde Tasarruf ve Led ampul kullanılmaktadır.  
Gövde: Polikarbon Renk: Beyaz Duy: Porselen E-27 Kablo: Standart  
Lens: Akrilik prizmatik, opal lensli Çerçeve: PC Profil

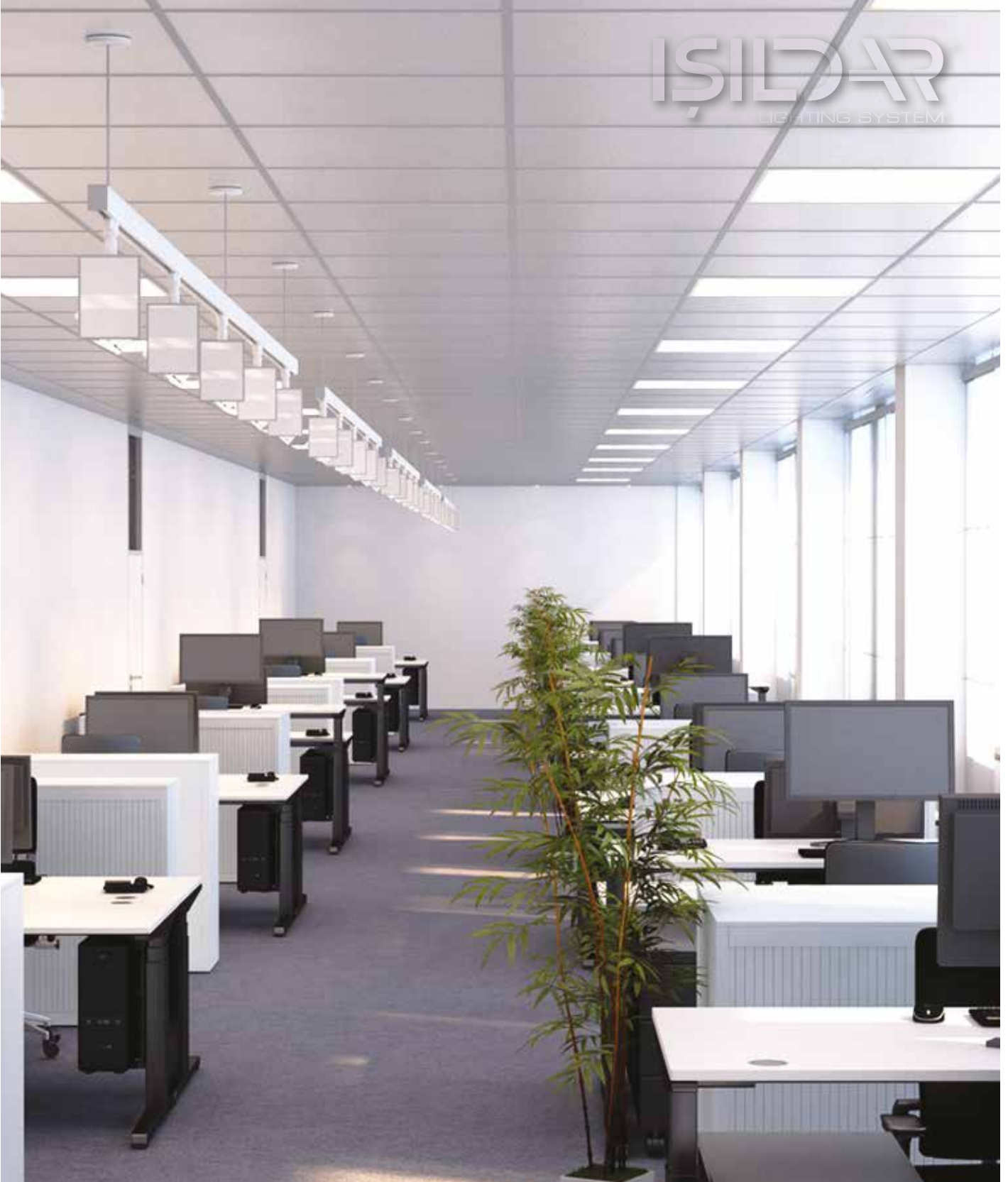



İŞILDAR  
LIGHTING SYSTEM

LED



İŞILDAR  
LIGHTING SYSTEM

Led'li Sıva Altı Ofis Armatürleri  
Led'li Sıva Üstü Ofis Armatürleri  
Led'li CLIP-IN Ofis Armatürleri  
Led'li Backlight Ürünler  
Led'li Sıva Altı Slim Panel Armatürler  
Plastik Sıva Üstü Slim Led Panel Çerçevesel  
Sıva Üstü Dekoratif Sac Led Panel Çerçevesel  
Led'li Bant Armatürler  
LED'li Projektörler  
Led'li Tavan Glop Armatürleri

LED'li ÜRÜNLER

03

LED'Lİ SIVA ALTI OPAL LENSİLİ BACKLIGHT ARMATÜRLER

LED



Kod	Kasa Ölçüsü	Güç	Renk	Lümen	Amb. Ad.	Koli Ad.	Fiyat (\$) USD
12 022 001 400 04014	30x60	20 W	4000K	2100	2	10	61.00
12 022 001 650 04015	30x60	20 W	6500K	2100	2	10	61.00
12 030 001 400 04016	60x60	40 W	4000K	4150	2	6	77.00
12 030 001 650 04017	60x60	40 W	6500K	4150	2	6	77.00
12 040 001 400 04020	30x120	40 W	4000K	4150	2	4	78.00
12 040 001 650 04021	30x120	40 W	6500K	4150	2	4	78.00
12 040 001 400 04022	60x120	80 W	4000K	8300	2	2	163.00
12 040 001 650 04023	60x120	80 W	6500K	8300	2	2	163.00

LED'Lİ SIVA ALTI STERİL ORTAM TEMPERLİ CAMLI ARMATÜRLER IP65

LED



Kod	Kasa Ölçüsü	Güç	Renk	Lümen	Amb. Ad.	Koli Ad.	Fiyat (\$) USD
16 218 001 400 03170	30x60	40 W	4000K	4150	2	4	149.00
16 218 001 650 03170	30x60	40 W	6500K	4150	2	4	149.00
16 418 001 400 03171	60x60	80 W	4000K	8300	2	4	219.00
16 418 001 650 03171	60x60	80 W	6500K	8300	2	4	219.00
16 236 001 400 03172	30x120	80 W	4000K	8300	2	4	239.00
16 236 001 650 03172	30x120	80 W	6500K	8300	2	4	239.00

Gövde DKP sac

Difüzör Prizmatik Lensli ve Opal Lensli

Driver OSRAM veya TRIDONIC Sabit akım çıkışlı, yüksek verimli Pf > 0,95

Gövde Rengi RAL 9016 elektrostatik toz boyalı

Reflektör Yüksek teknolojiyle donatılmış %99.90 saflıkta anodize (eloksallı) alüminyum

Led Markası OSRAM



## LED'Lİ SIVA ÜSTÜ OPAL LENSLİ BACKLIGHT ARMATÜRLER



LED

Kod	Kasa Ölçüsü	Güç	Renk	Lümen	Amb. Ad.	Koli Ad.	Fiyat (\$) USD
22 022 001 400 04038	30x60	20 W	4000K	2100	2	10	68.00
22 022 001 650 04039	30x60	20 W	6500K	2100	2	10	68.00
22 030 001 400 04040	60x60	40 W	4000K	4150	2	6	91.00
22 030 001 650 04041	60x60	40 W	6500K	4150	2	6	91.00
22 040 001 400 04044	30x120	40 W	4000K	4150	2	4	92.00
22 040 001 650 04045	30x120	40 W	6500K	4150	2	4	92.00
22 040 001 400 04046	60x120	80 W	4000K	8300	2	2	179.00
22 040 001 650 04047	60x120	80 W	6500K	8300	2	2	179.00

## LED'Lİ SIVA ÜSTÜ STERİL ORTAM TEMPERLİ CAMLI ARMATÜRLER IP65



LED

Kod	Kasa Ölçüsü	Güç	Renk	Lümen	Amb. Ad.	Koli Ad.	Fiyat (\$) USD
26 218 001 400 03173	30x60	40 W	4000K	4150	2	4	159.00
26 218 001 650 03173	30x60	40 W	6500K	4150	2	4	159.00
26 418 001 400 03174	60x60	80 W	4000K	8300	2	4	229.00
26 418 001 650 03174	60x60	80 W	6500K	8300	2	4	229.00
26 236 001 400 03175	30x120	80 W	4000K	8300	2	4	249.00
26 236 001 650 03175	30x120	80 W	6500K	8300	2	4	249.00

Gövde DKP sac

Difüzör Prizmatik Lensli ve Opal Lensli

Driver OSRAM veya TRIDONIC Sabit akım çıkışlı, yüksek verimli Pf &gt; 0,95

Gövde Rengi RAL 9016 elektrostatik toz boyalı

Reflektör Yüksek teknolojiyle donatılmış %99.90 saflıkta anodize (eloksallı) alüminyum

Led Markası OSRAM



**5W LED'Lİ SIVA ALTI COB ARMATÜRLER (İTHAL)**

Kod	Güç	Kasa Rengi	Renk	Lümen	Amb. Ad.	Koli Ad.	Fiyat (\$) USD
12 005 001 400 04122	5 W	Beyaz	4000K	400	1	100	7.95
12 005 001 650 04123	5 W	Beyaz	6500K	400	1	100	7.95
12 005 001 400 04124	5 W	Nikel	4000K	400	1	100	7.95
12 005 001 650 04125	5 W	Nikel	6500K	400	1	100	7.95

**LED'Lİ SIVA ALTI SLİM PANEL ARMATÜRLER (İTHAL)**

Kod	Güç	Ölçü (cm)	Renk	Lümen	Amb. Ad.	Koli Ad.	Fiyat (\$) USD
12 020 001 400 04094	20 W	30x30	4000K	1310	1	20	39.50
12 020 001 650 04095	20 W	30x30	6500K	1310	1	20	39.50
12 028 001 400 04096	28 W	30x60	4000K	1820	1	10	53.00
12 028 001 650 04097	28 W	30x60	6500K	1820	1	10	53.00
12 036 001 400 04098	36 W	60x60	4000K	2900	1	5	57.00
12 036 001 650 04099	36 W	60x60	6500K	2900	1	5	57.00
12 054 001 400 04100	54 W	60x60	4000K	4800	1	5	85.00
12 054 001 650 04101	54 W	60x60	6500K	4800	1	5	85.00

**LED'Lİ SIVA ALTI KARE SLİM PANEL ARMATÜRLER (İTHAL)**

Kod	Güç	Ölçü (mm)	Renk	Lümen	Amb. Ad.	Koli Ad.	Fiyat (\$) USD
12 006 001 400 04102	6 W	120x120x25	4000K	410	1	60	6.95
12 006 001 650 04103	6 W	120x120x25	6500K	410	1	60	6.95
12 012 001 400 04104	12 W	173x173x25	4000K	850	1	40	11.50
12 012 001 650 04105	12 W	173x173x25	6500K	850	1	40	11.50
12 018 001 400 04106	18W	225x225x25	4000K	1350	1	20	16.50
12 018 001 650 04107	18W	225x225x25	6500K	1350	1	20	16.50

**LED'Lİ SIVA ALTI YUVARLAK SLİM PANEL ARMATÜRLER (İTHAL)**

Kod	Güç	Ölçü (mm)	Renk	Lümen	Amb. Ad.	Koli Ad.	Fiyat (\$) USD
12 003 001 400 04108	3 W	85x27	4000K	230	1	100	4.95
12 003 001 650 04109	3 W	85x27	6500K	230	1	100	4.95
12 006 001 400 04110	6 W	120x24	4000K	410	1	60	6.95
12 006 001 650 04111	6 W	120x24	6500K	410	1	60	6.95
12 009 001 400 04112	9 W	146x26	4000K	740	1	40	8.50
12 009 001 650 04113	9 W	146x26	6500K	740	1	40	8.50
12 012 001 400 04114	12 W	171x27	4000K	850	1	40	10.25
12 012 001 650 04115	12 W	171x27	6500K	850	1	40	10.25
12 015 001 400 04116	15 W	200x25	4000K	1160	1	20	12.95
12 015 001 650 04117	15 W	200x25	6500K	1160	1	20	12.95
12 018 001 400 04118	18 W	222x25	4000K	1350	1	20	15.00
12 018 001 650 04119	18 W	222x25	6500K	1350	1	20	15.00
12 024 001 400 04120	24 W	300x24	4000K	1770	1	10	34.00
12 024 001 650 04121	24 W	300x24	6500K	1770	1	10	34.00

## LED'Lİ CLIP-IN OPAL LENSLİ BACKLIGHT ARMATÜRLER 30X30

Kod	Güç	Renk	Lümen	Amb. Ad.	Koli Ad.	Fiyat (\$) USD
12 012 001 400 07103	12 W	4000K	1100	4	24	46.00
12 012 001 650 07104	12 W	6500K	1100	4	24	46.00

## LED'Lİ CLIP-IN OPAL LENSLİ BACKLIGHT ARMATÜRLER

Kod	Kasa Ölçüsü	Güç	Renk	Lümen	Amb. Ad.	Koli Ad.	Fiyat (\$) USD
12 210 001 400 07113	30x60	20 W	4000K	2100	2	10	66.00
12 210 001 650 07114	30x60	20 W	6500K	2100	2	10	66.00
12 410 001 400 07115	60x60	40 W	4000K	4150	2	6	81.00
12 410 001 650 07116	60x60	40 W	6500K	4150	2	6	81.00
12 220 001 400 07117	30x120	40 W	4000K	4150	2	4	82.00
12 220 001 650 07118	30x120	40 W	6500K	4150	2	4	82.00
12 420 001 400 07119	60x120	80 W	4000K	8300	2	2	168.00
12 420 001 650 07120	60x120	80 W	6500K	8300	2	2	168.00

## 30x30 LED'Lİ BACKLIGHT ÜRÜNLER

## 30X30 LED'Lİ SIVA ALTI BACKLIGHT ARMATÜRLER

Kod	Güç	Cinsi	Renk	Lümen	Amb. Ad.	Koli Ad.	Fiyat (\$) USD
12 012 001 400 04012	12 W	Opal	4000K	1100	4	24	45.00
12 012 001 650 04013	12 W	Opal	6500K	1100	4	24	45.00

## 30X30 LED'Lİ SIVA ÜSTÜ BACKLIGHT ARMATÜRLER

Kod	Güç	Cinsi	Renk	Lümen	Amb. Ad.	Koli Ad.	Fiyat (\$) USD
22 012 001 400 04036	12 W	Opal	4000K	1100	4	20	47.00
22 012 001 650 04037	12 W	Opal	6500K	1100	4	20	47.00

Gövde  
Difüzör  
Driver

DKP sac  
Opal Lensli  
OSRAM veya TRIDONIC Sabit akım çıkışlı,  
yüksek verimli Pf > 0,95

Gövde Rengi

RAL 9016 elektrostatik toz boyalı

Led Markası

OSRAM

## SIVA ÜSTÜ TROY LED'LI DEKORATİF TAVAN ARMATÜRÜ

YENİ

LED



Kod	Güç	Çap (mm)	Renk	Lümen	Amb. Ad.	Koli Ad.	Fiyat (\$) USD
22 024 001 400 04195	24 W	300	4000K	1820	1	12	25.00
22 024 001 650 04196	24 W	300	6500K	1820	1	12	25.00
22 024 001 750 04197	24 W	300	RGB	1820	1	12	29.00



## SIVA ÜSTÜ TROY LED'Lİ DEKORATİF RADAR SENSÖRLÜ TAVAN ARMATÜRÜ

YENİ

LED RADAR SENSÖRLÜ

Kod	Güç	Çap (mm)	Renk	Lümen	Amb. Ad.	Koli Ad.	Fiyat (\$) USD
22 024 001 400 04198	24 W	300	4000K	1820	1	12	47.00
22 024 001 650 04199	24 W	300	6500K	1820	1	12	47.00
22 024 001 750 05001	24 W	300	RGB	1820	1	12	51.00

## PLASTİK SIVA ÜSTÜ SLİM LED PANEL ÇERÇEVELERİ

YENİ

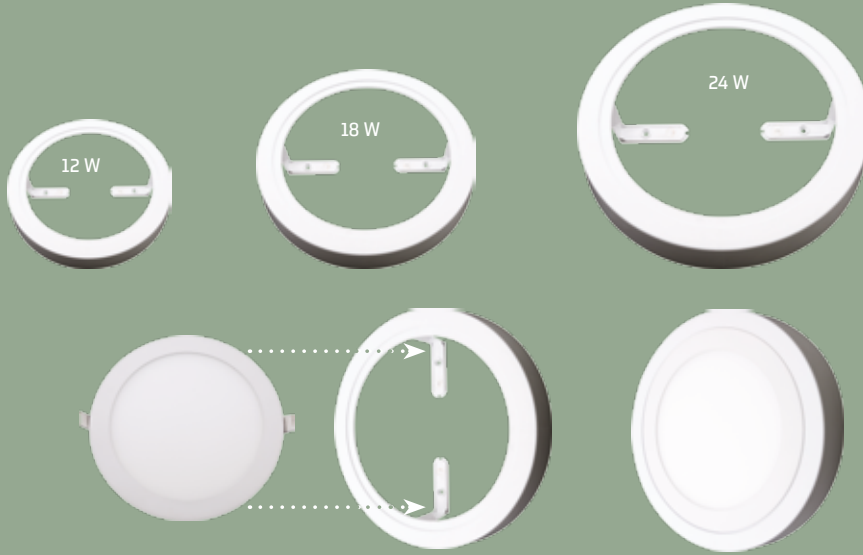

Kod	Cinsi	Dış ø Ölçü	İç ø Ölçü	Amb. Ad.	Koli Ad.	Fiyat (₺)
90 000 000 000 9053	12 W Led Panel İçin	221x40 mm	174 mm	-	48	6.25
90 000 000 000 9054	18 W Led Panel İçin	272x40 mm	225 mm	-	36	8.25
90 000 000 000 9055	24 W Led Panel İçin	350x40 mm	303 mm	-	24	9.95

**DÖRTLÜ KARE SLİM PANEL ÇERÇEVELERİ**



Kod	Güç	Ölçü	Amb. Ad.	Koli Ad.	Fiyat (₺)
900 000 6000 9000	4x6 W	600x600x45	1	10	52.00
900 001 2000 9000	4x12 W	600x600x45	1	10	52.00
900 001 8000 9000	2x18 W	600x600x45	1	10	52.00

**DÖRTLÜ YUVARLAK SLİM PANEL ÇERÇEVELERİ**



Kod	Güç	Ölçü	Amb. Ad.	Koli Ad.	Fiyat (₺)
900 000 3000 9002	4x3 W	600x600x45	1	10	72.00
900 000 6000 9002	4x6 W	600x600x45	1	10	72.00
900 000 9000 9002	4x9 W	600x600x45	1	10	72.00
900 001 2000 9002	4x12 W	600x600x45	1	10	72.00
900 001 5000 9002	4x15 W	600x600x45	1	10	72.00
900 001 8000 9002	2x18 W	600x600x45	1	10	72.00
900 002 4000 9002	2x24 W	600x600x45	1	10	72.00

**DÖRTLÜ YUVARLAK SLİM PANEL ÇERÇEVELERİ**



Kod	Güç	Ölçü	Amb. Ad.	Koli Ad.	Fiyat (₺)
900 000 3000 9001	4x3 W	600x600x45	1	10	52.00
900 000 6000 9001	4x6 W	600x600x45	1	10	52.00
900 000 9000 9001	4x9 W	600x600x45	1	10	52.00
900 001 2000 9001	4x12 W	600x600x45	1	10	52.00
900 001 5000 9001	4x15 W	600x600x45	1	10	52.00
900 001 8000 9001	2x18 W	600x600x45	1	10	52.00
900 002 4000 9001	2x24 W	600x600x45	1	10	52.00



Gövde DKP sac  
Gövde Rengi RAL 9016 elektrostatik toz boyalı Beyaz ve Siyah

**LED ÜRÜNLER DAHİL DEĞİLDİR**  
Çerçeve için özel tasarımlar uygulanır.





## SIVA ÜSTÜ SLİM LED PANEL ARMATÜR ÇERÇEVELERİ



Kod	Ölçü	Amb. Ad.	Koli Ad.	Fiyat (₺)
90 000 000 000 9041	300x300x45	1	40	35.00
90 000 000 000 9042	300x600x45	1	20	43.00
90 000 000 000 9044	600x600x45	1	10	49.00
90 000 000 000 9012	300x1200x45	1	10	54.00

## CLIP-IN SLİM LED PANEL ARMATÜR ÇERÇEVELERİ

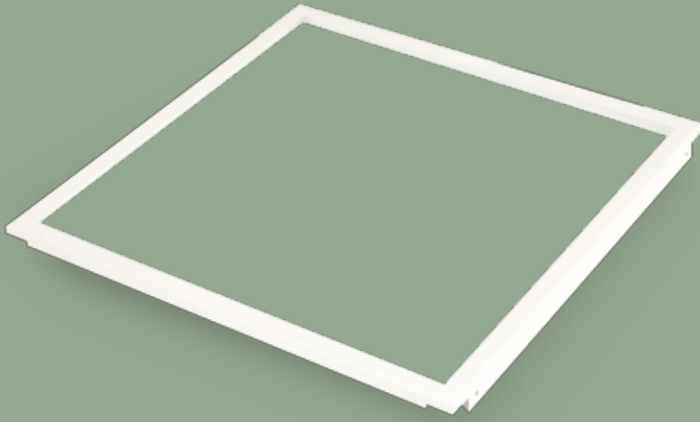

Kod	Ölçü	Amb. Ad.	Koli Ad.	Fiyat (₺)
90 000 000 000 9045	300x300x45	1	144	24.00
90 000 000 000 9046	300x600x45	1	20	32.00
90 000 000 000 9048	600x600x45	1	36	38.00
90 000 000 000 9013	300x1200x45	1	10	43.00

Gövde RAL 9016 elektrostatik toz boyalı DKP sac



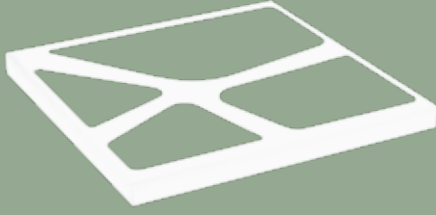

KOD: 90 000 000 000 9009

Ölçü	Amb. Ad.	Koli Ad.	Fiyat (₺)
600x600x45	1	10	52.00

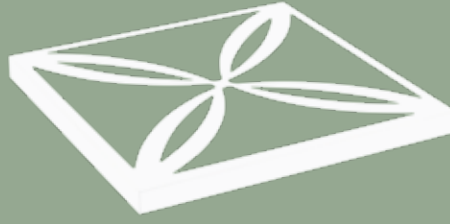

KOD: 90 000 000 000 9005

Ölçü	Amb. Ad.	Koli Ad.	Fiyat (₺)
600x600x45	1	10	52.00



KOD: 90 000 000 000 9005

Ölçü	Amb. Ad.	Koli Ad.	Fiyat (₺)
600x600x45	1	10	52.00



KOD: 90 000 000 000 9051

Ölçü	Amb. Ad.	Koli Ad.	Fiyat (₺)
600x600x45	1	10	52.00

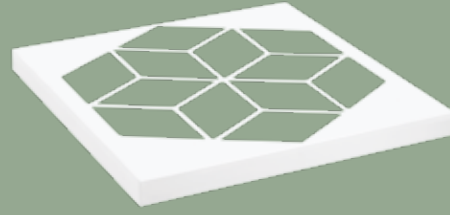

KOD: 90 000 000 000 9011

Ölçü	Amb. Ad.	Koli Ad.	Fiyat (₺)
600x600x45	1	10	52.00



KOD: 90 000 000 000 9052

Ölçü	Amb. Ad.	Koli Ad.	Fiyat (₺)
600x600x45	1	10	52.00



KOD: 90 000 000 000 9003

Ölçü	Amb. Ad.	Koli Ad.	Fiyat (₺)
600x600x45	1	10	52.00



KOD: 90 000 000 000 9008

Ölçü	Amb. Ad.	Koli Ad.	Fiyat (₺)
600x600x45	1	10	52.00

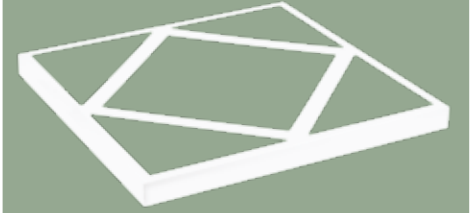

KOD: 90 000 000 000 9006

Ölçü	Amb. Ad.	Koli Ad.	Fiyat (₺)
600x600x45	1	10	52.00



KOD: 90 000 000 000 9011

Ölçü	Amb. Ad.	Koli Ad.	Fiyat (₺)
600x600x45	1	10	52.00

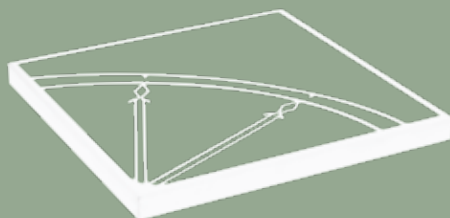

KOD: 90 000 000 000 9010

Ölçü	Amb. Ad.	Koli Ad.	Fiyat (₺)
600x600x45	1	10	52.00

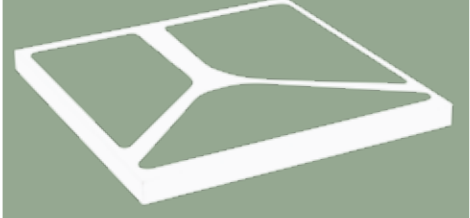

KOD: 90 000 000 000 9004

Ölçü	Amb. Ad.	Koli Ad.	Fiyat (₺)
600x600x45	1	10	52.00

Gövde RAL 9016 elektrostatik toz boyalı DKP sac

Çerçeveler için özel tasarımlar uygulanır.



LED



03

LED 'Lİ BANT ARMATÜRLER  
PROJEKTÖRLER VE  
TAVAN GLOP ARMATÜRLERİ

**LED 'Lİ BANT ARMATÜRLERİ**

Kod	Güç	Renk	Lümen	Amb. Ad.	Koli Ad.	Fiyat (\$) USD
22 009 001 400 04048	9 W	4000K	900	1	48	<b>12.00</b>
22 009 001 650 04049	9 W	6500K	900	1	48	<b>12.00</b>
22 018 001 400 04050	18 W	4000K	1600	1	24	<b>17.00</b>
22 018 001 650 04051	18 W	6500K	1600	1	24	<b>17.00</b>
22 024 001 400 04052	24 W	4000K	2400	1	12	<b>22.00</b>
22 024 001 650 04053	24 W	6500K	2400	1	12	<b>22.00</b>
22 032 001 400 04054	32 W	4000K	3000	1	12	<b>27.00</b>
22 032 001 650 04055	32 W	6500K	3000	1	12	<b>27.00</b>

**LED 'Lİ T1 TSC OKUL ARMATÜRLERİ**

Kod	Güç	Renk	Lümen	Amb. Ad.	Koli Ad.	Fiyat (\$) USD
22 012 001 400 04062	1x18/12 W	4000K	1405	2	12	<b>53.00</b>
22 012 001 650 04063	1x18/12 W	6500K	1405	2	12	<b>53.00</b>
22 024 001 400 04064	2x18/24 W	4000K	2810	2	8	<b>69.00</b>
22 024 001 650 04200	2x18/24 W	6500K	2810	2	8	<b>69.00</b>
22 024 001 400 04201	1x36/24 W	4000K	2810	2	8	<b>69.00</b>
22 024 001 650 04202	1x36/24 W	6500K	2810	2	8	<b>69.00</b>
22 048 001 400 04066	2x36/48 W	4000K	5620	2	8	<b>105.00</b>
22 048 001 650 04067	2x36/48 W	6500K	5620	2	8	<b>105.00</b>

**LED 'Lİ U1 TİPİ ETANJ ARMATÜRLERİ**

Kod	Güç	Renk	Lümen	Amb. Ad.	Koli Ad.	Fiyat (\$) USD
22 012 001 400 04056	1x18/12 W	4000K	1405	2	12	<b>52.00</b>
22 012 001 650 04057	1x18/12 W	6500K	1405	2	12	<b>52.00</b>
22 024 001 400 04058	2x18/24 W	4000K	2810	2	8	<b>65.00</b>
22 024 001 650 04059	2x18/24 W	6500K	2810	2	8	<b>65.00</b>
22 024 001 400 04203	1x36/24 W	4000K	2810	2	8	<b>65.00</b>
22 024 001 650 04204	1x36/24 W	6500K	2810	2	8	<b>65.00</b>
22 048 001 400 04060	2x36/48 W	4000K	5620	2	8	<b>99.00</b>
22 048 001 650 04061	2x36/48 W	6500K	5620	2	8	<b>99.00</b>

**LED 'Lİ YÜKSEK TAVAN ARMATÜRLERİ**

Kod	Güç	Renk	Lümen	Amb. Ad.	Koli Ad.	Fiyat (\$) USD
22 048 001 400 04080	2x54/48 W	4000K	5620	2	2	<b>165.00</b>
22 048 001 650 04081	2x54/48 W	6500K	5620	2	2	<b>165.00</b>
22 072 001 400 04082	2x80/72 W	4000K	7160	2	2	<b>199.00</b>
22 072 001 650 04083	2x80/72 W	6500K	7160	2	2	<b>199.00</b>
22 096 001 400 04084	4x54/96 W	4000K	11240	1	1	<b>299.00</b>
22 096 001 650 04085	4x54/96 W	6500K	11240	1	1	<b>299.00</b>
22 144 001 400 04086	4x80/144 W	4000K	14320	1	1	<b>359.00</b>
22 144 001 650 04087	4x80/144 W	6500K	14320	1	1	<b>359.00</b>

## 85X65 NOVA ALÜMİNYUM GÖVDE LED'Lİ LİNEER ARMATÜRLER

Kod	Güç	Renk	Lümen	Amb. Ad.	Koli Ad.	Fiyat (\$) USD
22 012 001 400 04068	60cm/12 W	4000K	1405	-	4	75.00
22 012 001 650 04069	60cm/12 W	6500K	1405	-	4	75.00
22 024 001 400 04070	120cm/24 W	4000K	2810	-	4	105.00
22 024 001 650 04071	120cm/24 W	6500K	2810	-	4	105.00
22 036 001 400 04072	150cm/36 W	4000K	3580	-	4	129.00
22 036 001 650 04073	150cm/36 W	6500K	3580	-	4	129.00

## SIVA ALTI LED'Lİ OPAL DİFÜZÖRLÜ LİNEER ARMATÜRLER

Kod	Güç	Renk	Lümen	Amb. Ad.	Koli Ad.	Fiyat (\$) USD
22 024 001 400 04088	60cm/24 W	4000K	1405	-	4	95.00
22 024 001 650 04089	60cm/24 W	6500K	1405	-	4	95.00
22 048 001 400 04090	120cm/48 W	4000K	2810	-	4	140.00
22 048 001 650 04091	120cm/48 W	6500K	2810	-	4	140.00
22 072 001 400 04092	150cm/72 W	4000K	3580	-	4	195.00
22 072 001 650 04093	150cm/72 W	6500K	3580	-	4	195.00



**LED'Lİ AQUA TAVAN GLOP ARMATÜRLERİ (SAC GÖVDE VE CAM)**

Kod	Ürün Adı	Güç	Renk Skalası	Lümen	Amb. Ad.	Koli Ad.	Fiyat (\$) USD
22 012 001 400 04142	Beyaz	12 W	4000K	2220	1	24	35.00
22 012 001 650 04203	Beyaz	12 W	6500K	2220	1	24	35.00
22 012 001 400 04143	Krom	12 W	4000K	2220	1	24	39.00
22 012 001 650 04204	Krom	12 W	6500K	2220	1	24	39.00
22 012 001 400 04144	Nikel	12 W	4000K	2220	1	24	39.00
22 012 001 650 04205	Nikel	12 W	6500K	2220	1	24	39.00

**LED'Lİ AQUA MEDIUM TAVAN GLOP ARMATÜRLERİ (SAC GÖVDE VE CAM)**

Kod	Ürün Adı	Güç	Renk Skalası	Lümen	Amb. Ad.	Koli Ad.	Fiyat (\$) USD
22 016 001 400 04206	Beyaz	16 W	4000K	2664	1	24	39.00
22 016 001 650 04209	Beyaz	16 W	6500K	2664	1	24	39.00
22 016 001 400 04207	Krom	16 W	4000K	2664	1	24	43.00
22 016 001 650 04210	Krom	16 W	6500K	2664	1	24	43.00
22 016 001 400 04208	Nikel	16 W	4000K	2664	1	24	43.00
22 016 001 650 04211	Nikel	16 W	6500K	2664	1	24	43.00

**LED'Lİ IP 65 ELEGANCE SOFT NEMLİ YER GLOP ARMATÜRLERİ (POLİKARBON)**

Kod	Ürün Adı	Güç	Renk Skalası	Lümen	Amb. Ad.	Koli Ad.	Fiyat (\$) USD
25 024 001 001 04151	Kafessiz Beyaz	24 W	4000K-6500K	2960	1	16	22.00
25 024 001 001 04152	Kafesli Beyaz	24 W	4000K-6500K	2960	1	16	22.25
25 024 001 001 04153	Şapkalı Beyaz	24 W	4000K-6500K	2960	1	16	22.50
25 024 001 003 04154	Kafessiz Gri	24 W	4000K-6500K	2960	1	16	22.50
25 024 001 003 04155	Kafesli Gri	24 W	4000K-6500K	2960	1	16	22.75
25 024 001 003 04156	Şapkalı Gri	24 W	4000K-6500K	2960	1	16	23.00
25 024 001 002 04157	Kafessiz Siyah	24 W	4000K-6500K	2960	1	16	22.50
25 024 001 002 04158	Kafesli Siyah	24 W	4000K-6500K	2960	1	16	22.75
25 024 001 002 04159	Şapkalı Siyah	24 W	4000K-6500K	2960	1	16	23.00

**LED'Lİ IP 65 ORKİDE SOFT OVAL NEMLİ YER GLOP ARMATÜRLERİ (POLİKARBON)**

Kod	Ürün Adı	Güç	Renk Skalası	Lümen	Amb. Ad.	Koli Ad.	Fiyat (\$) USD
25 012 001 001 04160	Kafessiz Beyaz	12 W	4000K-6500K	2220	1	30	19.00
25 012 001 001 04161	Kafesli Beyaz	12 W	4000K-6500K	2220	1	30	19.10
25 012 001 001 04162	Şapkalı Beyaz	12 W	4000K-6500K	2220	1	30	19.20
25 012 001 003 04163	Kafessiz Gri	12 W	4000K-6500K	2220	1	30	19.20
25 012 001 003 04164	Kafesli Gri	12 W	4000K-6500K	2220	1	30	19.30
25 012 001 003 04165	Şapkalı Gri	12 W	4000K-6500K	2220	1	30	19.40
25 012 001 002 04166	Kafessiz Siyah	12 W	4000K-6500K	2220	1	30	19.20
25 012 001 002 04167	Kafesli Siyah	12 W	4000K-6500K	2220	1	30	19.30
25 012 001 002 04168	Şapkalı Siyah	12 W	4000K-6500K	2220	1	30	19.40



Kod	Güç	Renk Skalası	Lümen	Adet		Fiyat (\$) USD
				Kutu	Koli	
46 010 001 400 04169	10 W	4000K	480	1	50	17.00
46 010 001 650 04170	10 W	6500K	480	1	50	17.00
46 020 001 400 04172	20 W	4000K	950	1	20	32.00
46 020 001 650 04173	20 W	6500K	950	1	20	32.00
46 030 001 400 04175	30 W	4000K	1350	1	20	39.00
46 030 001 650 04176	30 W	6500K	1350	1	20	39.00
46 050 001 400 04178	50 W	4000K	2250	1	10	53.00
46 050 001 650 04179	50 W	6500K	2250	1	10	53.00
46 070 001 400 04181	70 W	4000K	3150	1	5	99.50
46 070 001 650 04182	70 W	6500K	3150	1	5	99.50
46 100 001 400 04183	100 W	4000K	4500	1	5	125.00
46 100 001 650 04184	100 W	6500K	4500	1	5	125.00

## LED 'Lİ YAPRAK CADDE VE SOKAK ARMATÜRLERİ (İTHAL)

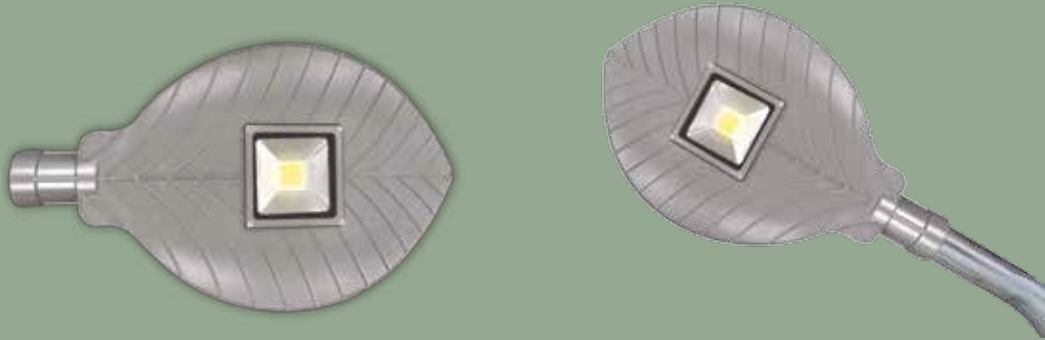

Kod	Ürün Adı	Güç	Renk Skalası	Lümen	Amb. Ad.	Koli Ad.	Fiyat (\$) USD
46 030 001 650 04185	Yaprak Modeli	30 W	4000K-6500K	3440	1	1	90.00
90 000 000 000 9014	Bağlantı Aparatı	-	-	-	1	1	15.00





İŞILDAR  
LIGHTING SYSTEM



İŞILDAR  
LIGHTING SYSTEM

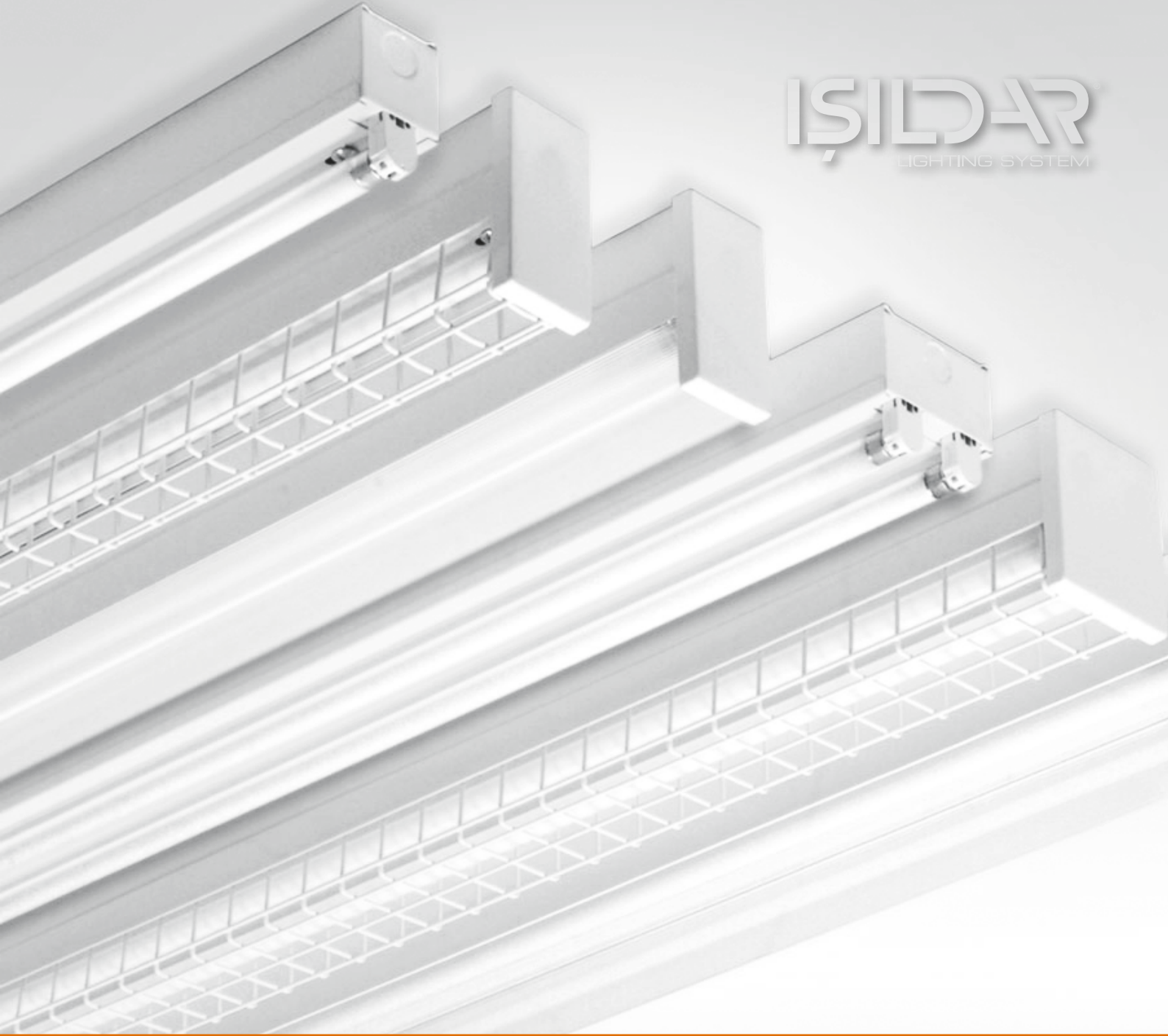

İŞILDAR®  
LIGHTING SYSTEM

T8 Bant Tipi Armatürler  
T5 Bant Tipi Armatürler

**BANT TİPİ ARMATÜRLER**

**04**

## T8 P1 TMS ARMATÜRLER (MANYETİK BALASTLI)



Kod	GÜÇ	Ampül	Balast	Amb. Ad.	Koli Ad.	Fiyat (₺)
22 118 002 001 03176	1x18 W	T26	Manyetik	6	6	38.00
22 218 002 001 03177	2x18 W	T26	Manyetik	6	6	41.00
22 136 002 001 03178	1x36 W	T26	Manyetik	6	6	43.50
22 236 002 001 03179	2x36 W	T26	Manyetik	6	6	67.00
22 158 002 001 03180	1x58 W	T26	Manyetik	6	6	71.00
22 258 002 001 03181	2x58 W	T26	Manyetik	6	6	109.00

Gövde: DKP Sac Boya: Elektrostatik toz Duy: Darbe ve ısıya dayanıklı TSE'li Balast: TSE'li Bakır Sargılı  
Kablo: Halogen Free Starter: General ve Osram marka

## T8 ETANJ DUYLU TMS ARMATÜRLER (MANYETİK BALASTLI)



Kod	GÜÇ	Ampül	Balast	Amb. Ad.	Koli Ad.	Fiyat (₺)
22 118 002 001 03282	1x18 W	T26	Manyetik	2	12	56.00
22 218 002 001 03283	2x18 W	T26	Manyetik	2	12	59.50
22 136 002 001 03284	1x36 W	T26	Manyetik	2	8	59.50
22 236 002 001 03285	2x36 W	T26	Manyetik	2	8	124.00
22 158 002 001 03286	1x58 W	T26	Manyetik	-	6	95.00
22 258 002 001 03287	2x58 W	T26	Manyetik	-	6	144.00

Gövde: DKP Sac Boya: Elektrostatik toz Duy: Darbe ve ısıya dayanıklı TSE'li Balast: TSE'li Bakır Sargılı  
Kablo: Halogen Free Starter: General ve Osram marka

## LAMEL ASMA TAVAN ARMATÜRLER (MANYETİK BALASTLI)



Kod	GÜÇ	Ürün Adı	Ampül	Balast	Amb. Ad.	Koli Ad.	Fiyat (₺)
22 118 002 001 03208	1x18 W	-	T26	Manyetik	2	8	74.00
22 118 002 001 03215	1x18 W	Prizmatik	T26	Manyetik	2	8	81.00
22 118 002 001 03216	1x18 W	Opal	T26	Manyetik	2	8	85.00
22 136 002 001 03209	1x36 W	-	T26	Manyetik	2	8	109.00
22 136 002 001 03217	1x36 W	Prizmatik	T26	Manyetik	2	8	118.00
22 136 002 001 03218	1x36 W	Opal	T26	Manyetik	2	8	123.00
22 158 002 001 03210	1x58 W	-	T26	Manyetik	2	8	129.00
22 158 002 001 03219	1x58 W	Prizmatik	T26	Manyetik	2	8	139.00
22 158 002 001 03220	1x58 W	Opal	T26	Manyetik	2	8	146.00

Gövde: DKP Sac Boya: Elektrostatik toz Duy: Darbe ve ısıya dayanıklı TSE'li Balast: TSE'li Bakır Sargılı  
Kablo: Halogen Free Starter: General ve Osram marka

## U1 TİPİ T8 ETANJ ARMATÜRLER (MANYETİK BALASTLI)



Kod	GÜÇ	Ampül	Balast	Amb. Ad.	Koli Ad.	Fiyat (₺)
26 118 002 003 01287	1x18 W	T26	Manyetik	2	12	59.50
26 218 002 003 01288	2x18 W	T26	Manyetik	2	12	68.00
26 136 002 003 01289	1x36 W	T26	Manyetik	2	8	77.00
26 236 002 003 01290	2x36 W	T26	Manyetik	2	8	96.00

Gövde ve Cam: Polikarbon Boya: Elektrostatik toz Duy: Darbe ve ısıya dayanıklı TSE'li Balast: TSE'li Bakır Sargılı  
Kablo: Halogen Free Starter: General ve Osram marka

## T1 TSC T8 OKUL ARMATÜRLER (MANYETİK BALASTLI)



Kod	GÜÇ	Ampül	Balast	Amb. Ad.	Koli Ad.	Fiyat (₺)
24 118 002 001 03211	1x18 W	T26	Manyetik	2	12	62.00
24 218 002 001 03212	2x18 W	T26	Manyetik	2	12	74.00
24 136 002 001 03213	1x36 W	T26	Manyetik	2	8	98.00
24 236 002 001 03214	2x36 W	T26	Manyetik	2	8	108.00

Gövde: DKP Sac Boya: Elektrostatik toz Duy: Darbe ve ısıya dayanıklı TSE'li Balast: TSE'li Bakır Sargılı  
Kablo: Halogen Free Starter: General ve Osram marka Cam: Akrilik

## T8 P1 TMS ARMATÜRLER (ELEKTRONİK BALASTLI)

Kod	GÜÇ	Ampül	Balast	Amb. Ad.	Koli Ad.	Fiyat (₺)
22 118 003 001 03176	1x18 W	T26	Elektronik	2	12	69.50
22 218 003 001 03177	2x18 W	T26	Elektronik	2	12	83.00
22 136 003 001 03178	1x36 W	T26	Elektronik	2	8	84.00
22 236 003 001 03179	2x36 W	T26	Elektronik	2	8	94.00
22 158 003 001 03180	1x58 W	T26	Elektronik	2	6	86.00
22 258 003 001 03181	2x58 W	T26	Elektronik	2	6	114.00

Gövde: DKP Sac Boya: Elektrostatik toz Duy: Darbe ve ısıya dayanıklı TSE'li Balast: Osram veya Tridonic (50.000 saat ömürlü)  
Kablo: Halogen Free TSE'li

## T8 ETANJ DUYLU TMS ARMATÜRLER (ELEKTRONİK BALASTLI)

Kod	GÜÇ	Ampül	Balast	Amb. Ad.	Koli Ad.	Fiyat (₺)
22 118 003 001 03282	1x18 W	T26	Elektronik	2	12	89.50
22 218 003 001 03283	2x18 W	T26	Elektronik	2	12	114.00
22 136 003 001 03284	1x36 W	T26	Elektronik	2	8	115.00
22 236 003 001 03285	2x36 W	T26	Elektronik	2	8	129.00
22 158 003 001 03286	1x58 W	T26	Elektronik	2	6	118.00
22 258 003 001 03287	2x58 W	T26	Elektronik	2	6	152.00

Gövde: DKP Sac Boya: Elektrostatik toz Duy: Darbe ve ısıya dayanıklı TSE'li Balast: Osram veya Tridonic (50.000 saat ömürlü)  
Kablo: Halogen Free TSE'li

## LAMEL ASMA TAVAN ARMATÜRLER (ELEKTRONİK BALASTLI)

Kod	GÜÇ	Ürün Adı	Ampül	Balast	Amb. Ad.	Koli Ad.	Fiyat (₺)
22 118 003 001 03208	1x18 W	-	T26	Elektronik	2	8	106.00
22 118 003 001 03215	1x18 W	Prizmatik	T26	Elektronik	2	8	112.00
22 118 003 001 03216	1x18 W	Opal	T26	Elektronik	2	8	117.00
22 136 003 001 03209	1x36 W	-	T26	Elektronik	2	8	145.00
22 136 003 001 03217	1x36 W	Prizmatik	T26	Elektronik	2	8	153.00
22 136 003 001 03218	1x36 W	Opal	T26	Elektronik	2	8	159.00
22 158 003 001 03210	1x58 W	-	T26	Elektronik	2	8	166.00
22 158 003 001 03219	1x58 W	Prizmatik	T26	Elektronik	2	8	175.00
22 158 003 001 03220	1x58 W	Opal	T26	Elektronik	2	8	182.00

Gövde: Alüminyum Eloksal Boya: Elektrostatik toz Duy: Darbe ve ısıya dayanıklı TSE'li  
Balast: Osram veya Tridonic (50.000 saat ömürlü) Kablo: Halogen Free TSE'li Cam: Prizmatik ve Opal seçenekleri Akrilik

## U1 TİPİ T8 ETANJ ARMATÜRLER (ELEKTRONİK BALASTLI)

Kod	GÜÇ	Ampül	Balast	Amb. Ad.	Koli Ad.	Fiyat (₺)
26 118 003 001 01287	1x18 W	T26	Elektronik	2	12	95.00
26 218 003 001 01288	2x18 W	T26	Elektronik	2	12	113.00
26 136 003 001 01289	1x36 W	T26	Elektronik	2	8	116.00
26 236 003 001 01290	2x36 W	T26	Elektronik	2	8	125.00
26 158 003 001 01291	1x58 W	T26	Elektronik	2	4	169.00
26 258 003 001 01292	2x58 W	T26	Elektronik	2	4	189.00

Gövde ve Cam: Polikarbon Sac: Elektrostatik toz boyalı Duy: Darbe ve ısıya dayanıklı TSE'li  
Balast: Osram veya Tridonic (50.000 saat ömürlü) Kablo: Halogen Free TSE'li

## T1 TSC T8 OKUL ARMATÜRLER (ELEKTRONİK BALASTLI)

Kod	GÜÇ	Ampül	Balast	Amb. Ad.	Koli Ad.	Fiyat (₺)
24 118 003 001 03211	1x18 W	T26	Elektronik	2	12	106.00
24 218 003 001 03212	2x18 W	T26	Elektronik	2	12	125.00
24 136 003 001 03213	1x36 W	T26	Elektronik	2	8	135.00
24 236 003 001 03214	2x36 W	T26	Elektronik	2	8	139.00

Gövde: DKP Sac Boya: Elektrostatik toz Duy: Darbe ve ısıya dayanıklı TSE'li Balast: Osram veya Tridonic (50.000 saat ömürlü)  
Kablo: Halogen Free TSE'li Cam: Akrilik



## T5 P1 TMS ARMATÜRLER (ELEKTRONİK BALASTLI)



Kod	GÜÇ	Ampül	Balast	Amb. Ad.	Koli Ad.	Fiyat (₺)
22 114 003 001 03238	1x14-24 W	T16	Elektronik	-	6	79.00
22 214 003 001 03239	2x14-24 W	T16	Elektronik	-	6	86.00
22 212 003 001 03240	1x21-39 W	T16	Elektronik	-	6	87.50
22 221 003 001 03241	2x21-39 W	T16	Elektronik	-	6	97.00
22 128 003 001 03242	1x28-54 W	T16	Elektronik	-	6	88.00
22 228 003 001 03243	2x28-54 W	T16	Elektronik	-	6	98.00
22 135 003 001 03244	1x35-49 W	T16	Elektronik	-	20	102.00
22 235 003 001 03245	2x35-49 W	T16	Elektronik	-	20	119.50
22 180 003 001 03246	1x80 W	T16	Elektronik	-	20	106.00
22 280 003 001 03247	2x80 W	T16	Elektronik	-	20	137.00

Gövde: DKP Sac Boya: Elektrostatik toz Duy: Darbe ve ısıya dayanıklı TSE'li  
Balast: Osram veya Tridonic (50.000 saat ömürlü) Kablo: Halogen Free TSE'li

## T5 ETANJ DUYLU TMS ARMATÜRLER (ELEKTRONİK BALASTLI)



Kod	GÜÇ	Ampül	Balast	Amb. Ad.	Koli Ad.	Fiyat (₺)
22 142 003 001 03104	1x14-24 W	T16	Elektronik	2	12	98.00
22 214 003 001 03105	2x14-24 W	T16	Elektronik	2	12	125.00
22 121 003 001 03106	1x21-39 W	T16	Elektronik	2	8	102.00
22 221 003 001 03107	2x21-39 W	T16	Elektronik	2	8	132.00
22 128 003 001 03108	1x28-54 W	T16	Elektronik	2	8	115.00
22 228 003 001 03109	2x28-54 W	T16	Elektronik	2	8	137.00
22 135 003 001 03110	1x35-49 W	T16	Elektronik	2	6	109.00
22 235 003 001 03111	2x35-49 W	T16	Elektronik	2	6	159.00
22 180 003 001 03112	1x80 W	T16	Elektronik	2	6	137.00
22 280 003 001 03113	2x80 W	T16	Elektronik	2	6	195.00

Gövde: DKP Sac Boya: Elektrostatik toz Duy: Darbe ve ısıya dayanıklı TSE'li  
Balast: Osram veya Tridonic (50.000 saat ömürlü) Kablo: Halogen Free TSE'li

## U1 TİPİ T5 ETANJ ARMATÜRLER (ELEKTRONİK BALASTLI)



Kod	GÜÇ	Ampül	Balast	Amb. Ad.	Koli Ad.	Fiyat (₺)
26 114 003 003 01287	1x14 W	T16	Elektronik	2	12	102.00
26 214 003 003 01288	2x14 W	T16	Elektronik	2	12	112.00
26 128 003 003 01289	1x28-54 W	T16	Elektronik	2	8	115.00
26 228 003 003 01290	2x28-54 W	T16	Elektronik	2	8	125.00

Gövde ve Cam: Polikarbon Sac: Elektrostatik toz boyalı Duy: Darbe ve ısıya dayanıklı TSE'li  
Balast: Osram veya Tridonic (50.000 saat ömürlü) Kablo: Halogen Free TSE'li

## T1 TSC T5 OKUL ARMATÜRLER (ELEKTRONİK BALASTLI)



Kod	GÜÇ	Ampül	Balast	Amb. Ad.	Koli Ad.	Fiyat (₺)
24 114 003 001 03211	1x14 W	T16	Elektronik	2	12	117.00
24 214 003 001 03212	2x14 W	T16	Elektronik	2	12	135.00
24 128 003 001 03213	1x28-54 W	T16	Elektronik	2	8	145.00
24 228 003 001 03214	2x28-54 W	T16	Elektronik	2	8	156.00

Gövde: DKP Sac Boya: Elektrostatik toz Duy: Darbe ve ısıya dayanıklı TSE'li Balast: Osram veya Tridonic (50.000 saat ömürlü)  
Kablo: Halogen Free TSE'li Cam: Akrilik

## T5 NOVA LİNEER 90X90 SAC VE ALÜMİNYUM ARMATÜRLER (ELEKTRONİK BALASTLI)

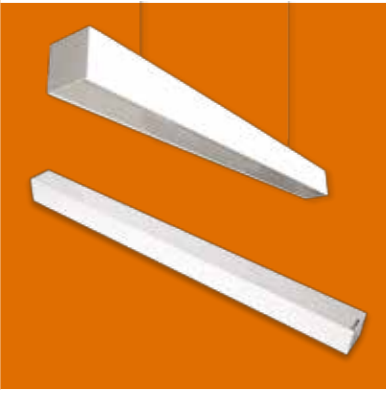

Kod	GÜÇ	Ampül	Balast	Amb. Ad.	Koli Ad.	Fiyat (₺)
22 128 003 001 03603	1x28-54 W	T16	Elektronik	4	4	<b>239.00</b>
22 228 003 001 03604	2x28-54 W	T16	Elektronik	4	4	<b>239.00</b>
22 135 003 001 03605	1x35-49 W	T16	Elektronik	4	4	<b>294.00</b>
22 235 003 001 03606	2x35-49 W	T16	Elektronik	4	4	<b>305.00</b>
22 180 003 001 03607	1x80 W	T16	Elektronik	4	4	<b>309.00</b>
22 280 003 001 03608	2x80 W	T16	Elektronik	4	4	<b>344.00</b>
90 000 000 000 9049	150 cm Askı Aparatı			2	Tk.	<b>59.00</b>

Gövde: DKP Sac veya Alüminyum Boya: Elektrostatik toz Duy: Darbe ve ısıya dayanıklı TSE'li Cam: Opal Difüzör  
Balast: Osram veya Tridonic (50.000 saat ömürlü) Kablo: Halogen Free TSE'li Renk Seçeneği: Farklı renk taleplerinde fiyat farkı uygulanır

## T5 NOVA LİNEER 85X65 ALÜMİNYUM ARMATÜRLER (ELEKTRONİK BALASTLI)



Kod	GÜÇ	Ampül	Balast	Amb. Ad.	Koli Ad.	Fiyat (₺)
22 128 003 001 03600	1x28-54 W	T16	Elektronik	4	4	<b>205.00</b>
22 135 003 001 03601	1x35-49 W	T16	Elektronik	4	4	<b>269.00</b>
22 180 003 001 03602	1x80 W	T16	Elektronik	2	4	<b>299.00</b>
90 000 000 000 9049	150 cm Askı Aparatı			2	Tk.	<b>59.00</b>

Gövde: Elokssallı Alüminyum Boya: Elektrostatik toz Duy: Darbe ve ısıya dayanıklı TSE'li Cam: Opal Difüzör  
Balast: Osram veya Tridonic (50.000 saat ömürlü) Kablo: Halogen Free TSE'li Renk Seçeneği: Farklı renk taleplerinde fiyat farkı uygulanır

## T5 LİNEER ALÜMİNYUM MARKET ARMATÜRLERİ (ELEKTRONİK BALASTLI)



Kod	GÜÇ	Ampül	Balast	Amb. Ad.	Koli Ad.	Fiyat (₺)
22 128 003 001 03248	1x28-54 W	T16	Elektronik	-	1	<b>252.00</b>
22 228 003 001 03249	2x28-54 W	T16	Elektronik	-	1	<b>275.00</b>
22 135 003 001 03250	1x35-49 W	T16	Elektronik	-	1	<b>286.00</b>
22 235 003 001 03251	2x35-49 W	T16	Elektronik	-	1	<b>319.00</b>
22 180 003 001 03252	1x80 W	T16	Elektronik	-	1	<b>299.00</b>
22 280 003 001 03253	2x80 W	T16	Elektronik	-	1	<b>399.00</b>

Gövde: Elokssallı Alüminyum Boya: Elektrostatik toz Duy: Darbe ve ısıya dayanıklı TSE'li Balast: Osram veya Tridonic (50.000 saat ömürlü)  
Kablo: Halogen Free TSE'li Reflektör: Yüksek teknoloji ile donatılmış %99.9 saflıkta anodize

## T5 YÜKSEK TAVAN ARMATÜRLERİ (ELEKTRONİK BALASTLI) IP65



Kod	GÜÇ	Ampül	Balast	Amb. Ad.	Koli Ad.	Fiyat (₺)
26 228 003 003 03230	2x28 W	T16	Elektronik	-	2	<b>379.00</b>
26 235 003 003 03231	2x35 W	T16	Elektronik	-	2	<b>479.00</b>
26 254 003 003 03232	2x54 W	T16	Elektronik	-	2	<b>379.00</b>
26 280 003 003 03233	2x80 W	T16	Elektronik	-	2	<b>459.00</b>
26 428 003 003 03334	4x28 W	T16	Elektronik	-	1	<b>597.00</b>
26 435 003 003 03235	4x35 W	T16	Elektronik	-	1	<b>723.00</b>
26 454 003 003 03236	4x54 W	T16	Elektronik	-	1	<b>597.00</b>
26 480 003 003 03237	4x80 W	T16	Elektronik	-	1	<b>799.00</b>

Gövde: DKP Sac Boya: Elektrostatik toz Duy: Darbe ve ısıya dayanıklı TSE'li Balast: Osram veya Tridonic (50.000 saat ömürlü)  
Cam: Tamperli ve filmli Kablo: Halogen Free TSE'li Reflektör: Yüksek teknoloji ile donatılmış %99.9 saflıkta anodize





**İŞILDAR**  
LIGHTING SYSTEM

İŞILDAR  
LIGHTING SYSTEM



İŞILDAR  
LIGHTING SYSTEM

E-27 Duylu Sac ve Cam Tavan Glop Armatürleri  
E-27 Duylu Plastik Gövde ve Cam Tavan Glop Armatürleri

TAVAN GLOP ARMATÜRLERİ

05

**AQUA TAVAN GLOP ARMATÜRLERİ (SAC TABAN VE CAM)**

**CAM**

Kod	Ürün Adı	Duy Tipi	Amb. Ad.	Koli Ad.	Fiyat (₺)
22 050 000 001 04186	Aqua Beyaz	1xE27	1	10	<b>61.00</b>
22 050 000 131 04187	Aqua Krom	1xE27	1	10	<b>69.00</b>
22 050 000 141 04188	Aqua Nikel	1xE27	1	10	<b>69.00</b>



**AQUA MEDIUM TAVAN GLOP ARMATÜRLERİ (SAC TABAN VE CAM)**

**CAM**

Kod	Ürün Adı	Duy Tipi	Amb. Ad.	Koli Ad.	Fiyat (₺)
22 050 000 001 04189	Aqua Medium Beyaz	1xE27	1	10	<b>89.00</b>
22 050 000 131 04190	Aqua Medium Krom	1xE27	1	10	<b>99.00</b>
22 050 000 141 04191	Aqua Medium Nikel	1xE27	1	10	<b>99.00</b>

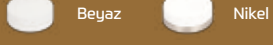

**AQUA MEGA TAVAN GLOP ARMATÜRLERİ (SAC TABAN VE CAM) ÇİFT DUYLU**

**CAM**

Kod	Ürün Adı	Duy Tipi	Amb. Ad.	Koli Ad.	Fiyat (₺)
22 050 000 001 04192	Aqua Mega Beyaz	2xE27	1	10	<b>95.00</b>
22 050 000 131 04193	Aqua Mega Krom	2xE27	1	10	<b>105.00</b>
22 050 000 141 04194	Aqua Mega Nikel	2xE27	1	10	<b>105.00</b>

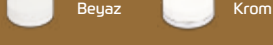

**DEKORATİF TROY E-27 DUYLU GLOP ARMATÜRLERİ (SAC TABAN VE PC. CAM)**

**CAM**

Kod	Ürün Adı	Duy Tipi	Amb. Ad.	Koli Ad.	Fiyat (₺)
22 025 000 000 01199	Troy Tek Duyulu	1xE27	1	12	<b>47.00</b>
22 050 000 000 01190	Troy Çift Duyulu	2xE27	1	12	<b>49.00</b>

**YENİ**





## TERRA DEKORATİF MİNİ GLOP ARMATÜR

YENİ



Kod	Ürün Adı	Duy Tipi	Amb. Ad.	Koli Ad.	Fiyat (₺)
22 020 000 001 01326	Terra Mini Şeffaf	1xE27	4	48	11.00
22 020 000 001 01327	Terra Mini Soft	1xE27	4	48	11.00
22 020 000 XXX 01328	Terra Mini Şeffaf Renkli	1xE27	4	48	14.00
22 020 000 XXX 01329	Terra Mini Soft Renkli	1xE27	4	48	14.00

## TERRA DEKORATİF GLOP ARMATÜR

YENİ



Kod	Ürün Adı	Duy Tipi	Amb. Ad.	Koli Ad.	Fiyat (₺)
22 025 000 001 01330	Terra Şeffaf	1xE27	4	40	13.00
22 025 000 001 01331	Terra Soft	1xE27	4	40	13.00
22 025 000 XXX 01332	Terra Şeffaf Renkli	1xE27	4	40	16.00
22 025 000 XXX 01333	Terra Soft Renkli	1xE27	4	40	16.00

## TERRA DEKORATİF GLOP ARMATÜR ÇİFT DUYLU

YENİ



Kod	Ürün Adı	Duy Tipi	Amb. Ad.	Koli Ad.	Fiyat (₺)
22 050 000 001 01334	Terra Şeffaf	2xE27	4	40	15.00
22 050 000 001 01335	Terra Soft	2xE27	4	40	15.00
22 050 000 XXX 01336	Terra Şeffaf Renkli	2xE27	4	40	18.00
22 050 000 XXX 01337	Terra Soft Renkli	2xE27	4	40	18.00

Renk



Kod

&gt; 101 Meşe

&gt; 111 Maun

&gt; 121 Ceviz

&gt; 131 Krom

&gt; 141 Nikel

&gt; 151 Altın

&gt; 161 PMavi

&gt; 171 Füme

Renkli ürünler için kodlama örneği : 22 025 000 XXX 01925 X değişkenleri için tercih ettiğiniz rengin kodunu belirtiniz

Örnek: 22 025 000 101 01925 - İla Meşe rengini belirtmiş olursunuz

## ELEGANCE NEMLİ YER ŞEFFAF GLOP ARMATÜRLERİ IP65



Kod	Ürün Adı	Duy Tipi	Amb. Ad.	Koli Ad.	Fiyat (₺)
25 025 000 001 01170	Kafessiz (Beyaz)	1xE27	1	16	19.90
25 025 000 001 01171	Kafesli (Beyaz)	1xE27	1	16	20.50
25 025 000 001 01172	Şapkalı (Beyaz)	1xE27	1	16	20.90
25 025 000 003 01173	Kafessiz (Gri)	1xE27	1	16	20.90
25 025 000 003 01174	Kafesli (Gri)	1xE27	1	16	21.50
25 025 000 003 01175	Şapkalı (Gri)	1xE27	1	16	21.90
25 025 000 002 01176	Kafessiz (Siyah)	1xE27	1	16	20.90
25 025 000 002 01177	Kafesli (Siyah)	1xE27	1	16	21.50
25 025 000 002 01178	Şapkalı (Siyah)	1xE27	1	16	21.90

## ELEGANCE NEMLİ YER SOFT GLOP ARMATÜRLERİ IP65



Kod	Ürün Adı	Duy Tipi	Amb. Ad.	Koli Ad.	Fiyat (₺)
25 025 000 001 01179	Kafessiz (Beyaz)	1xE27	1	16	19.90
25 025 000 001 01180	Kafesli (Beyaz)	1xE27	1	16	20.50
25 025 000 001 01181	Şapkalı (Beyaz)	1xE27	1	16	20.90
25 025 000 003 01182	Kafessiz (Gri)	1xE27	1	16	20.90
25 025 000 003 01183	Kafesli (Gri)	1xE27	1	16	21.50
25 025 000 003 01184	Şapkalı (Gri)	1xE27	1	16	21.90
25 025 000 002 01185	Kafessiz (Siyah)	1xE27	1	16	20.90
25 025 000 002 01186	Kafesli (Siyah)	1xE27	1	16	21.50
25 025 000 002 01187	Şapkalı (Siyah)	1xE27	1	16	21.90



**İLİA KARE TAVAN GLOP ARMATÜRLERİ**

Kod	Ürün Adı	Duy Tipi	Amb. Ad.	Koli Ad.	Fiyat (₺)
22 025 000 001 01140	İlia Beyaz	1xE27	1	24	14.00
22 025 000 XXX 01142	İlia Renkli	1xE27	1	24	17.00

**İLİA MEGA KARE TAVAN GLOP ARMATÜRLERİ ÇİFT DUYLU**

Kod	Ürün Adı	Duy Tipi	Amb. Ad.	Koli Ad.	Fiyat (₺)
22 025 000 001 01141	İlia Mega Beyaz	2xE27	1	10	26.00
22 025 000 XXX 01143	İlia Mega Renkli	2xE27	1	10	29.00

**İLİA JUMBO ÜÇGEN TAVAN GLOP ARMATÜRLERİ ÜÇ DUYLU**

Kod	Ürün Adı	Duy Tipi	Amb. Ad.	Koli Ad.	Fiyat (₺)
22 045 000 001 01144	İlia Jumbo Üçgen Beyaz	3xE27	1	10	29.50
22 045 000 XXX 01146	İlia Jumbo Üçgen Renkli	3xE27	1	10	32.50

**ELİT KARE TAVAN GLOP ARMATÜRLERİ**

Kod	Ürün Adı	Duy Tipi	Amb. Ad.	Koli Ad.	Fiyat (₺)
22 050 000 001 01155	Elit Beyaz	1xE27	1	24	14.00
22 050 000 xxx 01156	Elit Renkli	1xE27	1	24	17.00
22 050 000 001 01157	Elit Kafesli Beyaz	1xE27	1	24	15.00
22 050 000 xxx 01158	Elit Kafesli Renkli	1xE27	1	24	18.00

**ELİT MEGA KARE TAVAN GLOP ARMATÜRLERİ ÇİFT DUYLU**

Kod	Ürün Adı	Duy Tipi	Amb. Ad.	Koli Ad.	Fiyat (₺)
22 050 000 001 01159	Elit Mega Beyaz	2xE27	1	10	26.00
22 050 000 xxx 01160	Elit Mega Renkli	2xE27	1	10	29.00

Renk								
Kod	> 101 Meşe	> 111 Maun	> 121 Ceviz	> 131 Krom	> 141 Nikel	> 151 Altın	> 161 PMavi	> 171 Füme

Renkli ürünler için kodlama örneği : 22 025 000 XXX 01925 X değişkenleri için tercih ettiğiniz rengin kodunu belirtiniz  
Örnek: 22 025 000 101 01925 - İlia Meşe rengini belirtmiş olursunuz



## TAVAN GLOP ARMATÜRLERİ ÇİFT DUYLU



1167



1197



1124



1168



1196

Kod	Ürün Adı	Duy Tipi	Amb. Ad.	Koli Ad.	Fiyat (₺)
22 050 000 001 01124	Vizyon Beyaz	2xE27	2	24	14.00
22 050 000 xxx 01125	Vizyon Renkli	2xE27	2	24	17.00
22 050 000 001 01167	Nova Beyaz	2xE27	2	24	14.00
22 050 000 001 01168	Nova Soft Beyaz	2xE27	2	24	14.00
22 050 000 001 01195	Trend Alya Soft Beyaz	2xE27	1	10	25.00
22 050 000 001 01196	Trend Alya Beyaz	2xE27	1	10	25.00
22 050 000 002 01197	Trend Alya Soft Siyah	2xE27	1	10	25.00
22 050 000 002 01198	Trend Alya Siyah	2xE27	1	10	25.00

## METALİZE TAVAN GLOP ARMATÜRLERİ ÇİFT DUYLU



1167



1192



1147



1148



1151



1152



1149



1150

Kod	Ürün Adı	Duy Tipi	Amb. Ad.	Koli Ad.	Fiyat (₺)
22 050 000 001 01191	Trend Alya Soft	2xE27	1	10	25.00
22 050 000 001 01192	Trend Alya	2xE27	1	10	25.00
22 050 000 001 01147	Trend Papatya	2xE27	1	10	25.00
22 050 000 001 01148	Trend Atlas	2xE27	1	10	25.00
22 050 000 001 01149	Trend Damla	2xE27	1	10	25.00
22 050 000 001 01150	Trend Anatolia	2xE27	1	10	25.00
22 050 000 001 01151	Trend Riva	2xE27	1	10	25.50
22 050 000 001 01152	Trend Vizyon	2xE27	1	10	25.50
22 050 000 xxx 01193	Trend Alya Soft (Renkli)	2xE27	1	10	28.00
22 050 000 xxx 01194	Trend Alya (Renkli)	2xE27	1	10	28.00
22 050 000 xxx 01161	Trend Papatya (Renkli)	2xE27	1	10	28.00
22 050 000 xxx 01162	Trend Atlas (Renkli)	2xE27	1	10	28.00
22 050 000 xxx 01163	Trend Damla (Renkli)	2xE27	1	10	28.00
22 050 000 xxx 01164	Trend Anatolia (Renkli)	2xE27	1	10	28.00
22 050 000 xxx 01165	Trend Riva (Renkli)	2xE27	1	10	28.50
22 050 000 xxx 01166	Trend Vizyon (Renkli)	2xE27	1	10	28.50

Renk								
Kod	> 101 Meşe	> 111 Maun	> 121 Ceviz	> 131 Krom	> 141 Nikel	> 151 Altın	> 161 P.Mavi	> 171 Füme

Renkli ürünler için kodlama örneği : 22 025 000 XXX 01925 X değişkenleri için tercih ettiğiniz rengin kodunu belirtiniz  
Örnek: 22 025 000 101 01925 - İlla Meşe rengini belirtmiş olursunuz



**TREND DEKORATİF GLOP ARMATÜRLER**

Kod	Ürün Adı	Duy Tipi	Amb. Ad.	Koli Ad.	Fiyat (₺)
22 050 000 001 01111	Trend Soft (Beyaz-Siyah)	1xE27	2	24	11.90
22 050 000 001 01112	Trend Şeffaf (Beyaz-Siyah)	1xE27	2	24	11.90
22 050 000 001 01115	Trend Riva (Beyaz-Siyah)	1xE27	2	24	11.90
22 050 000 001 01188	Trend Alya (Beyaz-Siyah)	1xE27	2	24	11.90
22 050 000 xxx 01113	Trend Soft (Renkli)	1xE27	1	24	14.90
22 050 000 xxx 01114	Trend Şeffaf (Renkli)	1xE27	1	24	14.90
22 050 000 xxx 01116	Trend Riva (Renkli)	1xE27	1	24	14.90
22 050 000 xxx 01189	Trend Alya (Renkli)	1xE27	1	24	14.90

**MİNİ TREND DEKORATİF GLOP ARMATÜRLER**

Kod	Ürün Adı	Duy Tipi	Amb. Ad.	Koli Ad.	Fiyat (₺)
25 025 000 001 01126	Mini Trend (Beyaz)	1xE27	4	48	7.25
25 025 000 001 01134	Mini Trend Soft (Beyaz)	1xE27	4	48	7.25
25 025 000 001 01135	Mini Trend Alya (Beyaz)	1xE27	4	48	7.25
22 025 000 xxx 01127	Mini Trend (Renkli)	1xE27	4	48	10.25
22 025 000 xxx 01136	Mini Trend Soft (Renkli)	1xE27	4	48	10.25
22 025 000 xxx 01137	Mini Trend Alya (Renkli)	1xE27	4	48	10.25

**BÜYÜK TAVAN GLOP ARMATÜRLERİ**

Kod	Ürün Adı	Duy Tipi	Amb. Ad.	Koli Ad.	Fiyat (₺)
22 025 000 001 01102	Papatya (Beyaz)	1xE27	4	48	8.50
22 025 000 001 01105	Damla (Beyaz)	1xE27	4	48	8.50
22 025 000 xxx 01104	Papatya (Renkli)	1xE27	4	48	11.50
22 025 000 xxx 01107	Damla (Renkli)	1xE27	4	48	11.50

**MİNİ TAVAN GLOP ARMATÜRLERİ**

Kod	Ürün Adı	Duy Tipi	Amb. Ad.	Koli Ad.	Fiyat (₺)
22 025 000 001 01101	Mini Damla (Beyaz)	1xE27	4	48	6.90
22 025 000 001 01106	Mini Papatya (Beyaz)	1xE27	4	48	6.90
22 025 000 001 01109	Mini Riva (Beyaz)	1xE27	4	48	6.90
22 025 000 xxx 01103	Mini Damla (Renkli)	1xE27	4	48	9.90
22 025 000 xxx 01108	Mini Papatya (Renkli)	1xE27	4	48	9.90
22 025 000 xxx 01110	Mini Riva (Renkli)	1xE27	4	48	9.90

**DEKORATİF EKO GLOP ARMATÜRLERİ**

Kod	Ürün Adı	Duy Tipi	Amb. Ad.	Koli Ad.	Fiyat (₺)
22 015 000 001 01153	Eco Trend (Beyaz)	1xE27	8	64	5.50
22 015 000 xxx 01154	Eco Trend (Renkli)	1xE27	8	64	8.50

Renk

Kod



> 101 Meşe



> 111 Maun



> 121 Ceviz



> 131 Krom



> 141 Nikel



> 151 Altın



> 161 PMavi



> 171 Füre

Renkli ürünler için kodlama örneği : 22 025 000 xxx 01925 X değişkenleri için tercih ettiğiniz rengin kodunu belirtiniz

Örnek: 22 025 000 101 01925 - İlla Meşe rengini belirtmiş olursunuz





**ORKİDE ŞEFFAF OVAL APLİK IP65**

1932 1936 1940	Kod	Ürün Adı	Duy Tipi	Amb. Ad.	Koli Ad.	Fiyat (₺)
	25 025 000 001 01932	Orkide Kafesiz (Beyaz)	1xE27	1	30	12.00
25 025 000 001 01933	Orkide Kafesli (Beyaz)	1xE27	1	30	12.25	
25 025 000 001 01934	Orkide Şapkalı (Beyaz)	1xE27	1	30	12.50	
25 025 000 003 01935	Orkide Kafesiz (Gri)	1xE27	1	30	12.50	
25 025 000 003 01936	Orkide Kafesli (Gri)	1xE27	1	30	12.75	
25 025 000 003 01937	Orkide Şapkalı (Gri)	1xE27	1	30	12.95	
25 025 000 002 01938	Orkide Kafesiz (Siyah)	1xE27	1	30	12.50	
25 025 000 002 01939	Orkide Kafesli (Siyah)	1xE27	1	30	12.75	
25 025 000 002 01940	Orkide Şapkalı (Siyah)	1xE27	1	30	12.95	

**ORKİDE SOFT OVAL APLİK IP65**

1931 1945 1949	Kod	Ürün Adı	Duy Tipi	Amb. Ad.	Koli Ad.	Fiyat (₺)
	25 025 000 001 01941	Orkide Kafesiz (Beyaz)	1xE27	1	30	12.00
25 025 000 001 01942	Orkide Kafesli (Beyaz)	1xE27	1	30	12.25	
25 025 000 001 01943	Orkide Şapkalı (Beyaz)	1xE27	1	30	12.50	
25 025 000 003 01944	Orkide Kafesiz (Gri)	1xE27	1	30	12.50	
25 025 000 003 01945	Orkide Kafesli (Gri)	1xE27	1	30	12.75	
25 025 000 003 01946	Orkide Şapkalı (Gri)	1xE27	1	30	12.95	
25 025 000 002 01947	Orkide Kafesiz (Siyah)	1xE27	1	30	12.50	
25 025 000 002 01948	Orkide Kafesli (Siyah)	1xE27	1	30	12.75	
25 025 000 002 01949	Orkide Şapkalı (Siyah)	1xE27	1	30	12.95	

**İDEA DUVAR APLİK IP65**

1915 1916	Kod	Ürün Adı	Duy Tipi	Amb. Ad.	Koli Ad.	Fiyat (₺)
	24 025 000 001 01915	İdea Kafesiz (Beyaz)	1xE27	2	24	16.00
24 025 000 001 01916	İdea Kafesli (Beyaz)	1xE27	2	24	17.00	
24 025 000 xxx 01917	İdea Kafesiz (Renkli)	1xE27	2	24	19.00	
24 025 000 xxx 01918	İdea Kafesli (Renkli)	1xE27	2	24	19.90	

**İLİA DUVAR APLİK**

1952	Kod	Ürün Adı	Duy Tipi	Amb. Ad.	Koli Ad.	Fiyat (₺)
	22 025 000 001 01952	İlia Aplik (Beyaz)	1xE27	4	48	9.25
22 025 000 XXX 01954	İlia Aplik (Renkli)	1xE27	4	48	12.25	

**KAPALI DUVAR APLİK**

1901 1902	Kod	Ürün Adı	Duy Tipi	Amb. Ad.	Koli Ad.	Fiyat (₺)
	22 025 000 001 01901	Damla (Beyaz)	1xE27	4	48	9.25
22 025 000 001 01902	Papatya (Beyaz)	1xE27	4	48	9.25	
22 025 000 xxx 01903	Damla (Renkli)	1xE27	4	48	12.25	
22 025 000 xxx 01904	Papatya (Renkli)	1xE27	4	48	12.25	

Renk								
Kod	> 101 Meşe	> 111 Maun	> 121 Ceviz	> 131 Krom	> 141 Nikel	> 151 Altın	> 161 PMavi	> 171 Füme

Renkli ürünler için kodlama örneği : 22 025 000 XXX 01925 X değişkenleri için tercih ettiğiniz rengin kodunu belirtiniz  
Örnek: 22 025 000 101 01925 - İlia Meşe rengini belirtmiş olursunuz



## GALA KAPALI DUVAR APLİK

Kod	Ürün Adı	Duy Tipi	Amb. Ad.	Koli Ad.	Fiyat (₺)
22 025 000 001 01950	Gala (Beyaz)	1xE27	4	48	7.90
22 025 000 xxx 01951	Gala (Renkli)	1xE27	4	48	10.90

## VERA KAPALI DUVAR APLİK

Kod	Ürün Adı	Duy Tipi	Amb. Ad.	Koli Ad.	Fiyat (₺)
22 025 000 001 01921	Vera (Beyaz)	1xE27	4	48	8.25
22 025 000 xxx 01924	Vera (Renkli)	1xE27	4	48	11.25

## YARIM AY AÇIK DUVAR APLİK

Kod	Ürün Adı	Duy Tipi	Amb. Ad.	Koli Ad.	Fiyat (₺)
20 025 000 001 01911	Riva (Beyaz)	1xE27	4	48	7.50
20 025 000 001 01912	Papatya (Beyaz)	1xE27	4	48	7.50
20 025 000 xxx 01913	Riva (Renkli)	1xE27	4	48	10.50
20 025 000 xxx 01914	Papatya (Renkli)	1xE27	4	48	10.50

## AÇIK DUVAR APLİK

Kod	Ürün Adı	Duy Tipi	Amb. Ad.	Koli Ad.	Fiyat (₺)
20 025 000 001 01908	Damla (Beyaz)	1xE27	4	48	9.25
20 025 000 001 01909	Papatya (Beyaz)	1xE27	4	48	9.25
20 025 000 001 01910	IVY (Beyaz)	1xE27	4	48	9.25

## YELKEN AÇIK DUVAR APLİK

Kod	Ürün Adı	Duy Tipi	Amb. Ad.	Koli Ad.	Fiyat (₺)
20 025 000 001 01905	Yelken Ege	1xE27	2	32	9.75
20 025 000 001 01906	Yelken Bahar	1xE27	2	32	9.75
20 025 000 001 01907	Yelken Soft	1xE27	2	32	9.75

## DEKORATİF AÇIK DUVAR APLİK

Kod	Ürün Adı	Duy Tipi	Amb. Ad.	Koli Ad.	Fiyat (₺)
20 025 000 001 01919	Vista (Beyaz)	1xE27	4	48	9.75
20 025 000 xxx 01920	Vista (Renkli)	1xE27	4	48	12.75

Renk	Kod	> 101 Meşe	> 111 Maun	> 121 Ceviz	> 131 Krom	> 141 Nikel	> 151 Altın	> 161 PMavi	> 171 Füme

Renkli ürünler için kodlama örneği : 22 025 000 xxx 01925 X değişkenleri için tercih ettiğiniz rengin kodunu belirtiniz  
Örnek: 22 025 000 101 01925 - İlla Meşe rengini belirtmiş olursunuz

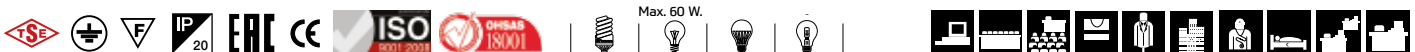

**32W VİDALI CAMLI METALİZE SİMİT ARMATÜRLER**



1263



1264

Kod	Ürün Adı	Balast	Amb. Ad.	Koli Ad.	Fiyat (₺)
22 032 002 181 01265	Trend Riva	Elektronik	1	10	54.50
22 032 003 181 01266	Trend Vizyon		1	10	54.50
22 032 003 181 01263	Trend Riva	Manyetik	1	10	45.50
22 032 003 181 01264	Trend Vizyon		1	10	45.50

**32W CAMLI METALİZE SİMİT ARMATÜRLER**

1255



1221



Kod	Ürün Adı	Balast	Amb. Ad.	Koli Ad.	Fiyat (₺)
22 032 003 181 01222	Trend Alya Soft	Elektronik	1	10	54.00
22 032 003 181 01223	Trend Alya		1	10	54.00
22 032 003 181 01259	Trend Papatya		1	10	54.00
22 032 003 181 01260	Trend Atlas		1	10	54.00
22 032 003 181 01261	Trend Damla		1	10	54.00
22 032 003 181 01262	Trend Anatolia		1	10	54.00
22 032 002 181 01220	Trend Alya Soft	Manyetik	1	10	45.00
22 032 002 181 01221	Trend Alya		1	10	45.00
22 032 002 181 01255	Trend Papatya		1	10	45.00
22 032 002 181 01256	Trend Atlas		1	10	45.00
22 032 002 181 01257	Trend Damla		1	10	45.00
22 032 002 181 01258	Trend Anatolia		1	10	45.00

**32W CAMLI METALİZE SİMİT ARMATÜRLER**

1211



1268



Kod	Ürün Adı	Balast	Amb. Ad.	Koli Ad.	Fiyat (₺)
22 032 003 181 01269	Alya Soft	Elektronik	1	10	49.50
22 032 003 181 01270	Alya		1	10	49.50
22 032 003 181 01204	Papatya		1	10	49.50
22 032 003 181 01213	Atlas		1	10	49.50
22 032 003 181 01205	Damla		1	10	49.50
22 032 002 181 01214	Anatolia		1	10	49.50
22 032 002 181 01267	Alya Soft	Manyetik	1	10	40.50
22 032 002 181 01268	Alya		1	10	40.50
22 032 002 181 01200	Papatya		1	10	40.50
22 032 002 181 01211	Atlas		1	10	40.50
22 032 002 181 01201	Damla		1	10	40.50
22 032 003 181 01212	Anatolia		1	10	40.50





**TERRA 360° SENSÖRLÜ PLASTİK TABAN VE CAM ARMATÜRLERİ**

**YENİ**

1339



1139



Kod	Ürün Adı	Duy Tipi	Amb. Ad.	Koli Ad.	Fiyat (₺)
22 050 000 001 01139	Terra Şeffaf	2xE27	1	10	44.00
22 050 000 001 01339	Terra Soft	2xE27	1	10	44.00
22 050 000 XXX 01338	Terra Şeffaf Renkli	2xE27	1	10	47.00
22 050 000 XXX 01346	Terra Soft Renkli	2xE27	1	10	47.00

**360° SENSÖRLÜ PLASTİK TABAN VE CAM ARMATÜRLERİ**

1121



1120



1128



Kod	Ürün Adı	Duy Tipi	Amb. Ad.	Koli Ad.	Fiyat (₺)
22 050 000 001 01120	Comfort Soft	2xE27	1	10	44.00
22 050 000 001 01121	Comfort Şeffaf	2xE27	1	10	44.00
22 050 000 xxx 01122	Comfort Soft (Renkli)	2xE27	1	10	47.00
22 050 000 xxx 01123	Comfort Şeffaf (Renkli)	2xE27	1	10	47.00
22 050 000 001 01128	Oval Vizyon	2xE27	1	10	46.00
22 050 000 xxx 01129	Oval Vizyon (Renkli)	2xE27	1	10	49.00

Renk



Kod > 101 Meşe > 111 Maun > 121 Ceviz > 131 Krom > 141 Nikel > 151 Altın > 161 PMavi > 171 Füme

Renkli ürünler için kodlama örneği : 22 025 000 XXX 01925 X değişkenleri için tercih ettiğiniz rengin kodunu belirtiniz  
Örnek: 22 025 000 101 01925 - İla Meşe rengini belirtmiş olursunuz



Max. 2x25 W.

**360° HAREKET SENSÖRÜ**

1000



1001



Kod	Ürün Adı	Amb. Ad.	Koli Ad.	Fiyat (₺)
22 000 000 001 01000	Sıva Üstü Hareket Sensörü	1	40	39.00
12 000 000 001 01001	Sıva Altı Hareket Sensörü	1	40	44.00



## 360° SENSÖRLÜ SAC TABAN VE CAM TAVAN ARMATÜRLERİ

1130



1145



Kod	Ürün Adı	Duy Tipi	Amb. Ad.	Koli Ad.	Fiyat (₺)
22 050 000 001 01130	Trend	2xE27	1	10	48.00
22 050 000 001 01145	Trend Şarjlı (Acilde Led)	2xE27	1	10	93.00



Max. 2x25 W.



## 360° SENSÖRLÜ SAC TABAN VE CAM FULL LED'Lİ VE ŞARJLI TAVAN ARMATÜRLERİ

1131



1132



LED

Kod	Ürün Adı	Renk	Amb. Ad.	Koli Ad.	Fiyat (₺)
22 024 000 400 01131	Trend Ledli	4000K	1	10	94.00
22 024 001 650 01131	Trend Ledli	6500K	1	10	94.00
22 024 000 400 01132	Trend Ledli / Şarjlı	4000K	1	10	123.00
22 024 001 650 01200	Trend Ledli / Şarjlı (Acilde Led)	6500K	1	10	123.00

## 360° SENSÖRLÜ SAC TABAN VE PLS. SOFT CAM FULL LED'Lİ VE ŞARJLI TAVAN ARMATÜRLERİ

YENİ

1133



1202



LED

Kod	Ürün Adı	Renk	Amb. Ad.	Koli Ad.	Fiyat (₺)
22 024 001 400 01133	Terra Ledli	4000K	1	10	86.00
22 024 001 650 01138	Terra Ledli	6500K	1	10	86.00
22 024 001 400 01202	Terra Ledli Şarjlı	4000K	1	10	113.00
22 024 001 650 01203	Terra Ledli Şarjlı	6500K	1	10	113.00



**180° İDEA E27 DUYLU SENSÖRLÜ DUVAR APLİK**



Kod	Ürün Adı	Duy Tipi	Amb. Ad.	Koli Ad.	Fiyat (₺)
22 025 000 001 01927	İdea Beyaz	1xE27	1	20	<b>45.50</b>
22 025 000 002 01929	İdea Siyah	1xE27	1	20	<b>45.50</b>
22 025 000 xxx 01928	İdea Renkli	1xE27	1	20	<b>48.50</b>



**180° İDEA FULL LED 'Lİ SENSÖRLÜ DUVAR APLİK**

**YENİ**



Kod	Ürün Adı	Renk	Amb. Ad.	Koli Ad.	Fiyat (₺)
22 025 000 001 03609	İdea Led'li Beyaz	6500K	1	20	<b>95.00</b>
22 025 000 001 03610	İdea Led'li Siyah	6500K	1	20	<b>95.00</b>

**LED 'Lİ ACIL ÇIKIŞ YÖNLENDİRME ARMATÜRLERİ**

**LED**



Kod	Ürün Adı	Renk	Amb. Ad.	Koli Ad.	Fiyat (₺)
32 008 001 650 08000	Exit acil yönlendirme tavan - duvara montaj	6500K	2	24	<b>88.00</b>
32 008 001 650 08100	Exit acil yönlendirme zincirle montaj	6500K	2	24	<b>88.00</b>
32 008 001 650 08xxx	Exit acil yönlendirme özel yön etiketli	6500K	2	24	<b>95.00</b>



3200800165008001



3200800165008003



3200800165008005



3200800165008007



3200800165008009



3200800165008002



3200800165008004



3200800165008006



3200800165008008



3200800165008010



**İŞILDAR**<sup>®</sup>  
LIGHTING SYSTEM



**İŞILDAR**<sup>®</sup>  
LIGHTING SYSTEM

Mini Vizyon Sarkı Armatürler  
Büyük Vizyon Sarkıt Armatürler  
Dantel Sarkıt Armatürler  
Rattan Sarkıt Armatürler

**SARKIT ARMATÜRLER**

**08**

**MİNİ VİZYON SARKIT ARMATÜRLER**



Kod	Ürün Adı	Duy Tipi	Amb. Ad.	Koli Ad.	Fiyat (₺)
20 040 000 001 01310	Mini Vizyon Beyaz	1xE27	4	48	17.00
20 040 000 002 01311	Mini Vizyon Siyah	1xE27	4	48	17.00
20 040 000 003 01312	Mini Vizyon Gri	1xE27	4	48	17.00

**BÜYÜK VİZYON SARKIT ARMATÜRLER**



Kod	Ürün Adı	Duy Tipi	Amb. Ad.	Koli Ad.	Fiyat (₺)
20 100 000 001 01315	Büyük Vizyon Beyaz	1xE27	4	16	22.00
20 100 000 002 01316	Büyük Vizyon Siyah	1xE27	4	16	22.00
20 100 000 003 01317	Büyük Vizyon Gri	1xE27	4	16	22.00

**DANTEL SARKIT ARMATÜRLER**



Kod	Ürün Adı	Duy Tipi	Amb. Ad.	Koli Ad.	Fiyat (₺)
20 060 000 191 01324	Dantel Sarkıt Krem	1xE27	4	16	22.00
20 060 000 201 01324	Dantel Sarkıt Pembe	1xE27	4	16	22.00
20 060 000 211 01324	Dantel Sarkıt Lila	1xE27	4	16	22.00

**RATTAN SARKIT ARMATÜRLER**



Kod	Ürün Adı	Duy Tipi	Amb. Ad.	Koli Ad.	Fiyat (₺)
20 060 000 001 01325	Rattan Sarkıt Beyaz	1xE27	4	16	22.00
20 060 000 002 01325	Rattan Sarkıt Siyah	1xE27	4	16	22.00
20 060 000 211 01325	Rattan Sarkıt Kahverengi	1xE27	4	16	22.00



**ISILDAR**  
LIGHTING SYSTEM

Plus Serisi PVC Kablo Kanalları  
Zemin Üstü PVC Kablo Kanalları  
Delikli PVC Kablo Kanalları

PVC KABLO KANALLARI

09

## PLUS SERİSİ



Kod	Kesit (mm)	Boy mt.	Ambalaj mt.	Fiyat (₺)
60 000 121 210 6000	12x12	2	320	0.83
60 000 151 010 6001	15x10	2	300	1.05
60 000 161 610 6002	16x16	2	180	1.25
60 000 201 010 6003	20x10	2	240	1.35
60 000 251 610 6004	25x16	2	154	1.70
60 000 252 510 6005	25x25	2	96	2.15
60 000 401 610 6006	40x16	2	84	2.70
60 000 402 510 6007	40x25	2	80	3.30
60 000 404 010 6008	40x40	2	72	3.90
60 000 604 010 6009	60x40	2	48	5.95
60 000 606 010 6010	60x60	2	40	7.50
60 000 804 010 6011	80x40	2	36	8.50
60 000 806 010 6012	80x60	2	32	8.95
60 000 104 010 6013	100x40	2	28	11.10
60 000 106 010 6014	100x60	2	24	11.50
60 000 126 010 6016	120x60	2	20	17.00

## PLUS SERİSİ YAPIŞKANLI



Kod	Kesit (mm)	Boy mt.	Ambalaj mt.	Fiyat (₺)
60 000 121 210 6100	12x12	2	320	1.06
60 000 151 010 6101	15x10	2	300	1.20
60 000 161 610 6102	16x16	2	180	1.50
60 000 201 010 6103	20x10	2	240	1.60
60 000 251 610 6104	25x16	2	154	2.25
60 000 252 510 6105	25x25	2	96	2.65
60 000 401 610 6106	40x16	2	84	3.50
60 000 402 510 6107	40x25	2	80	4.30
60 000 404 010 6108	40x40	2	72	4.95
60 000 604 010 6109	60x40	2	48	7.50

## DELİKLİ PANO KANALI (GRİ - MAVİ)

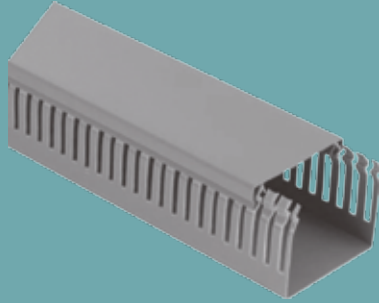

Kod	Kesit (mm)	Boy mt.	Ambalaj mt.	Fiyat (₺)
60 000 252 530 6400	25x25	2	100	4.55
60 000 254 030 6401	25x40	2	80	5.95
60 000 404 030 6403	40x40	2	72	7.40
60 000 406 030 6404	40x60	2	48	12.40
60 000 606 030 6406	60x60	2	32	14.70
60 000 608 030 6407	60x80	2	24	15.80

## DELİKLİ PANO KANALI YAPIŞKANLI (GRİ - MAVİ)

Kod	Kesit (mm)	Boy mt.	Ambalaj mt.	Fiyat (₺)
60 000 252 530 6500	25x25	2	100	5.50
60 000 254 030 6501	25x40	2	80	6.85
60 000 256 030 6502	25x60	2	72	9.15
60 000 404 030 6503	40x40	2	72	8.65

## ZEMİN ÜSTÜ (GRİ - MAVİ)

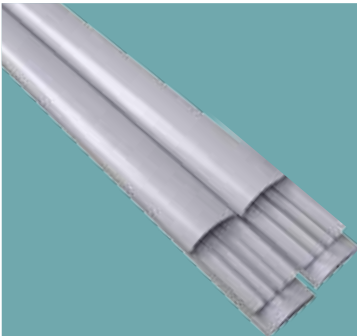

Kod	Kesit (mm)	Boy mt.	Ambalaj mt.	Fiyat (₺)
60 000 501 230 6200	50x12	2	60	5.95
60 000 702 030 6201	70x20	2	60	9.80
60 000 902 030 6202	90x20	2	24	16.05

## ZEMİN ÜSTÜ YAPIŞKANLI (GRİ - MAVİ)

Kod	Kesit (mm)	Boy mt.	Ambalaj mt.	Fiyat (₺)
60 000 501 230 6300	50x12	2	60	7.85
60 000 702 030 6301	70x20	2	60	10.95
60 000 902 030 6302	90x20	2	24	17.20





## İÇTEN KAPAKLI SİSTEM KANALI

Kod	Kesit (mm)	Boy mt.	Ambalaj mt.	Fiyat (₺)
60 000 105 010 6015	100x50	2	16	15.95

## SİSTEM KABLO KANALI EK PARÇA VE AKSESUARLARI

Kod	Cinsi	Ölçü	Ambalaj	Fiyat (₺)
60 000 000 010 6704	İç Köşe	-	12 Adet	6.35
60 000 000 010 6705	Dış Köşe	-	10 Adet	6.35
60 000 000 010 6706	T Bağlantı	900	12 Adet	7.50
60 000 000 010 6707	L Bağlantı	-	12 Adet	7.50
60 000 000 010 6708	Sonlandırma Uç Tapa	-	24 Adet	2.25
60 000 000 010 6709	Ek Parça	-	24 Adet	2.55
60 000 000 010 6710	Ara Bölme	-	120 mt	4.90
60 000 000 010 6711	Priz Montaj Seti 1'li	45x45 mm	12 Adet	4.03
60 000 000 010 6712	Priz Montaj Seti 2'li	45x45 mm	12 Adet	4.55
60 000 000 010 6713	Priz Montaj Seti 3'lü	45x45 mm	12 Adet	6.85
60 000 000 010 6714	Priz Montaj Seti 4'lü	45x45 mm	20 Adet	7.80

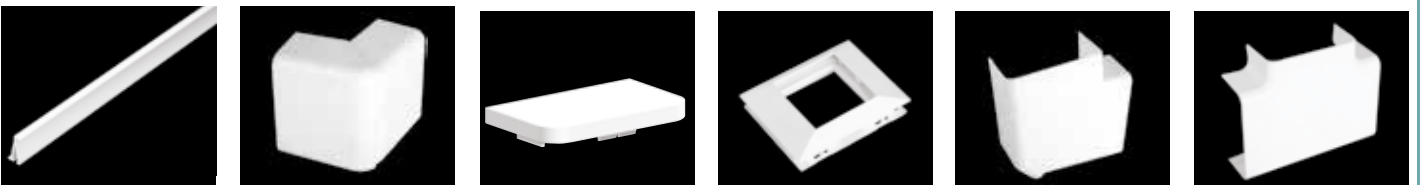



**ISILDAR**  
LIGHTING SYSTEM



**ISILDAR**  
LIGHTING SYSTEM

Sigorta Kutuları ve Klemensleri  
Kombinasyon Kutuları ve Makine Prizleri  
Polikarbon Pano ve Termoplastik Buatlar  
Sıva Üstü Antigron ve Kare Buatlar  
Plastik Dübel ve Kroşeler  
Plastik Sıra Klemensler ve Duylar

**10**

**PANOLAR - SİGORTA KUTULARI VE  
PLASTİK ELEKTRİK MALZEMELERİ**

**SİGORTA KUTULARI**



Kod	Ürün Adı	Amb. Ad.	Koli	Fiyat (₺)
14 000 000 210 2011	2'li Sıva Altı	1	48	6.90
24 000 000 210 2012	2'li Sıva Üstü	1	48	6.90
14 000 000 610 2013	2-6'lı Sıva Altı	1	36	11.80
24 000 000 610 2014	2-6'lı Sıva Üstü	1	36	11.80
14 000 000 910 2015	9'lu Sıva Altı	1	24	13.90
24 000 000 910 2016	9'lu Sıva Üstü	1	24	13.90
14 000 001 210 2017	12'li Sıva Altı	1	24	18.90
24 000 001 210 2018	12'li Sıva Üstü	1	24	18.90
14 000 001 610 2019	16'li Sıva Altı	1	12	25.90
24 000 001 610 2020	16'li Sıva Üstü	1	12	25.90
14 000 002 410 2021	24'lü Sıva Altı	1	10	31.00
24 000 002 410 2022	24'lü Sıva Üstü	1	10	31.00
14 000 001 610 2023	16'lı Sıva Altı <b>TEK SIRA</b> <b>YENİ</b>	1	16	25.90
24 000 001 610 2024	16'lı Sıva Üstü <b>TEK SIRA</b> <b>YENİ</b>	1	16	25.90

**SIVA ÜSTÜ SİGORTA KUTULARI**

Kod	Ürün Adı	Amb. Ad.	Koli	Fiyat (₺)
22 000 000 110 2000	1'li Sıva Üstü	30	360	1.35
22 000 000 210 2001	1-2'li Sıva Üstü	20	240	1.85
22 000 000 310 2002	3-4'lü Sıva Üstü	10	120	2.90

**SİGORTA KUTUSU KLEMENSLERİ**

Kod	Ürün Adı	Amb. Ad.	Koli	Fiyat (₺)
90 000 000 000 2037	4 Delikli (2-6'lı Sigorta Kutusu İçin)	30	100	1.45
90 000 000 000 2038	7 Delikli (9-16'lı Sigorta Kutusu İçin)	20	100	2.55
90 000 000 000 2039	9 Delikli (12-24'lü Sigorta Kutusu İçin)	10	100	3.70

## 120 X 205 1'Lİ KOMBİNASYON KUTULARI



2215



2214

Kod	Ürün Adı	Amb. Ad.	Koli	Fiyat (₺)
35 400 122 030 2214	120X205 1'li (Boş)	1	20	15.00
35 401 122 030 2215	1'li ( 1 Adet 3X25 A. Trifaze+ 2 Adet 1X16 A. Monofaze Priz)	1	20	45.00
35 402 122 030 2216	1'li ( 1 Adet 5X16 A. Trifaze+ 2 Adet 1X16 A. Monofaze Priz)	1	20	56.00
35 403 122 030 2217	1'li ( 1 Adet 5X32 A. Trifaze+ 2 Adet 1X16 A. Monofaze Priz)	1	20	62.00

## 180 X 270 2'Lİ KOMBİNASYON KUTULARI



2219



2218

Kod	Ürün Adı	Amb. Ad.	Koli	Fiyat (₺)
35 400 182 730 2218	180X270 2'li (Boş)	1	12	24.75
35 406 182 730 2219	2'li ( 2 Adet 3X25 A. Trifaze+ 2 Adet 1X16 A. Monofaze Priz)	1	12	66.00
35 407 182 730 2225	2'li ( 2 Adet 3X25 A. Trifaze+ 4 Adet 1X16 A. Monofaze Priz)	1	12	79.90
35 408 182 730 2220	2'li ( 2 Adet 5X16 A. Trifaze+ 2 Adet 1X16 A. Monofaze Priz)	1	12	91.00
35 403 182 730 2221	2'li ( 2 Adet 5X32 A. Trifaze+ 2 Adet 1X16 A. Monofaze Priz)	1	12	101.00
35 404 182 730 2222	2'li ( 1 Adet 3X25 A. Trifaze+ 1 Adet 5X16 A. Trifaze+ 2 Adet Monofaze Priz)	1	12	86.00

## MAKİNE PRİZLERİ



2251

2250

Kod	Ürün Adı	Amb. Ad.	Koli	Fiyat (₺)
90 000 000 000 2250	1x16 A. Monofaze Priz	1	-	6.25
90 000 000 000 2251	3x25 A. Trifaze Priz	1	-	12.50

**POLİKARBON DAĞITIM PANOLARI**



Kod	Ürün Adı	Amb. Ad.	Koli	Fiyat (₺)
45 400 223 030 2230	22x30x15 Polikarbon Etanj Pano	1	12	<b>48.00</b>
45 400 223 330 2233	22x30x15 Polikarbon Etanj Pano (Şeffaf Kapak)	1	12	<b>49.75</b>
46 500 304 030 2231	30x40x15 Polikarbon Etanj Pano	1	6	<b>78.00</b>
46 500 304 030 2232	30x40x15 Polikarbon Etanj Pano (Şeffaf Kapak)	1	6	<b>79.90</b>
46 500 355 030 2234	35x50x17 Polikarbon Etanj Pano	1	4	<b>110.00</b>
46 500 355 030 2235	35x50x17 Polikarbon Etanj Pano (Şeffaf Kapak)	1	4	<b>113.00</b>
46 500 406 030 2236	40x60x20 Polikarbon Etanj Pano	1	2	<b>122.00</b>
46 500 406 030 2237	40x60x20 Polikarbon Etanj Pano (Şeffaf Kapak)	1	2	<b>125.00</b>
46 500 507 030 2240	50x70x22 Polyester Etanj Pano	1	1	<b>359.00</b>

**TERMOPLASTİK BUATLAR**

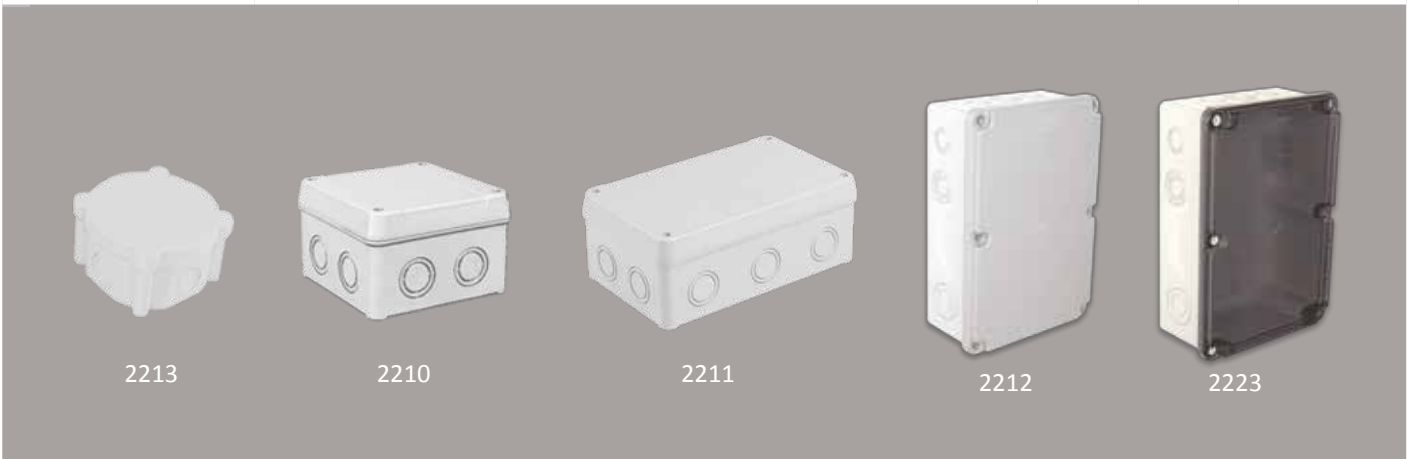

Kod	Ürün Adı	Amb. Ad.	Koli	Fiyat (₺)
55 400 111 130 2210	110x110x70 8 Çıkışlı Contalı Termoplastik Buat	10	100	<b>5.75</b>
55 400 111 830 2211	110x180x70 10 Çıkışlı Contalı Termoplastik Buat	6	60	<b>7.50</b>
55 400 182 130 2212	180x270x100 14 Çıkışlı Contalı Termoplastik Buat	2	24	<b>17.90</b>
55 400 182 130 2223	180x270x100 14 Çıkışlı Contalı Termoplastik Buat (Şeffaf Kapaklı)	2	24	<b>18.50</b>
55 400 009 030 2213	Çap 90 4 Çıkışlı Termoplastik Buat	24	240	<b>2.30</b>



## SIVA ÜSTÜ ANTİGRON VE KARE BUATLAR (GEÇMELİ KAPAK) SİYAH

Kod	Ürün Adı	Amb. Ad.	Koli	Fiyat (₺)
54 000 858 510 2201	85X85 Kare Antigron Buat ( Beyaz)	20	240	1.80
52 000 101 020 2203	10X10 Kare Buat ( Siyah)	15	180	1.90
52 000 131 320 2204	13X13 Kare Buat ( Siyah)	25	150	2.90
52 000 202 020 2205	20X20 Kare Buat ( Siyah)	10	60	6.35

## KARE BUATLAR (GEÇMELİ KAPAK) ORANJ

Kod	Ürün Adı	Amb. Ad.	Koli	Fiyat (₺)
52 000 101 040 2207	10X10 Kare Buat (Oranj)	15	180	2.30
52 000 131 340 2208	13X13 Kare Buat (Oranj)	25	150	3.50
52 000 202 040 2209	20X20 Kare Buat (Oranj)	10	60	8.10

## KASA VE BUATLAR SİYAH

Kod	Ürün Adı	Amb. Ad.	Koli	Fiyat (₺)
52 000 000 020 1802	Geçmeli Plastik Derin Kasa Kapaksız	100	1000	0.29
52 000 000 020 1801	Geçmeli Plastik Derin Kasa Kapaklı	100	1000	0.54
52 000 000 020 1805	Geçmeli Alçıpan Kasa	100	600	0.99
52 000 000 020 1816	Norm Plastik Kasa	100	1000	0.25
52 000 000 020 1808	Norm Kapaksız Buat	100	600	0.52
52 000 000 020 1807	Norm Kapaklı Buat	100	600	0.69
52 000 000 020 1818	Norm 14-18 mm Girişli Plastik Takoz	100	1000	0.36

## KASA VE BUATLAR ORANJ

Kod	Ürün Adı	Amb. Ad.	Koli	Fiyat (₺)
52 000 000 040 1804	Geçmeli Plastik Derin Kasa Kapaksız	100	1000	0.57
52 000 000 040 1803	Geçmeli Plastik Derin Kasa Kapaklı	100	1000	0.83
52 000 000 040 1806	Geçmeli Alçıpan Kasa	100	600	1.10
52 000 000 040 1817	Norm Plastik Kasa	100	1000	0.44
52 000 000 040 1810	Norm Kapaksız Buat	100	600	0.77
52 000 000 040 1809	Norm Kapaklı Buat	100	600	0.84

## LÜX BUAT KAPAKLARI

Kod	Ürün Adı	Amb. Ad.	Koli	Fiyat (₺)
52 000 000 010 2402	Çap 90 Bombeli Plastik Ayak	100	2000	0.26
52 000 000 010 2403	Çap 90 Vidalı Bombeli Plastik Ayak	100	2000	0.41
52 000 000 010 2404	Çap 120 Bombeli Plastik Ayak	100	1000	0.79

**PLASTİK DÜBELLER (POŞETLİ)**

	Kod	Ürün Adı	Amb. Ad.	Koli	Fiyat (₺)
	90 000 000 000 1501	6 mm Plastik Dübel	1000	30000	<b>0.023</b>
	90 000 000 000 1502	7 mm Plastik Dübel	1000	30000	<b>0.025</b>
	90 000 000 000 1503	8 mm Plastik Dübel	1000	30000	<b>0.033</b>
	90 000 000 001 1503	8 mm Plastik Dübel Köşeli	1000	30000	<b>0.037</b>
	90 000 000 000 1504	10 mm Plastik Dübel	500	15000	<b>0.056</b>
	90 000 000 000 1505	12 mm Plastik Dübel	500	5000	<b>0.120</b>
	90 000 000 000 1506	14 mm Plastik Dübel	500	5000	<b>0.220</b>
	90 000 000 000 1507	Plastik Kanal Dübeli	500	10000	<b>0.059</b>
	90 000 000 000 1508	Plastik Korniş Dübeli (Del-Çak)	500	10000	<b>0.071</b>
	90 000 000 000 1509	Alçıpan Dübeli (Kelebek)	500	10000	<b>0.065</b>
	90 000 000 000 1510	Alçıpan Turbolet Dübel	500	10000	<b>0.065</b>
	90 000 000 000 1513	8X60 Kasa ve Çerçeve Dübeli	500	10000	<b>0.095</b>
	90 000 000 000 1514	8X80 Kasa ve Çerçeve Dübeli	500	10000	<b>0.095</b>
	90 000 000 000 1515	8X100 Kasa ve Çerçeve Dübeli	500	10000	<b>0.095</b>
	90 000 000 000 1516	8 mm Tuğla Boşluk Dübeli	500	10000	<b>0.089</b>
	90 000 000 000 1517	10 mm Tuğla Boşluk Dübeli	500	10000	<b>0.095</b>
90 000 000 000 1518	Kablo Tutucu Dübeli	500	8000	<b>0.120</b>	

**PLASTİK DÜBELLER (100'LÜK POŞETLİ KUTULU)**

	Kod	Ürün Adı	Amb. Ad.	Koli	Fiyat (₺)
	90 000 000 000 1519	6mm 100'lük Plastik Dübel	100	30000	<b>0.028</b>
	90 000 000 000 1520	7mm 100'lük Plastik Dübel	100	30000	<b>0.029</b>
	90 000 000 000 1521	8mm 100'lük Plastik Dübel	100	30000	<b>0.037</b>
	90 000 000 000 1522	10mm 100'lük Plastik Dübel	100	15000	<b>0.063</b>

**ÇİVİLİ KROŞELER**

	Kod	Ürün Adı	Amb. Ad.	Koli	Fiyat (₺)
	90 000 000 000 1605	No.0 Çivili Kroşe	1000	20000	<b>0.029</b>
	90 000 000 000 1606	No.1 Çivili Kroşe	1000	20000	<b>0.029</b>
	90 000 000 000 1607	No.2 Çivili Kroşe	1000	20000	<b>0.029</b>
	90 000 000 000 1608	No.3 Çivili Kroşe	1000	20000	<b>0.039</b>
	90 000 000 000 1609	No.4 Çivili Kroşe	1000	20000	<b>0.039</b>
	90 000 000 000 1610	No.5 Çivili Kroşe	1000	10000	<b>0.053</b>
	90 000 000 000 1611	No.6 Çivili Kroşe	1000	10000	<b>0.053</b>
	90 000 000 000 1612	No.7 Çivili Kroşe	100	3000	<b>0.110</b>
	90 000 000 000 1613	No.8 Çivili Kroşe	100	2000	<b>0.145</b>

**PLASTİK ANTİGRON KROŞELER**

	Kod	Ürün Adı	Amb. Ad.	Koli	Fiyat (₺)
	90 000 000 000 1601	Antigrön Kroşe No.1	100	2000	<b>0.210</b>
	90 000 000 000 1602	Antigrön Kroşe No.1.5	100	2000	<b>0.220</b>
	90 000 000 000 1603	Antigrön Kroşe No.2	100	1000	<b>0.330</b>
	90 000 000 000 1604	Antigrön Kroşe No.3	50	750	<b>0.490</b>



PLASTİK SIRA KLEMENS

Kod	Ürün Adı	Amb. Ad.	Koli	Fiyat (₺)
90 000 000 000 2101	No.1 Sıra Klemens 2.5-4 mm	50	1000	2.200
90 000 000 000 2102	No.2 Sıra Klemens 4-6 mm	50	1000	2.800
90 000 000 000 2103	No.3 Sıra Klemens 10-16 mm	50	500	3.600
90 000 000 000 2104	No.4 Sıra Klemens 16-25 mm	50	500	4.300
90 000 000 000 2109	No.5 Sıra Klemens 16-25 mm	50	500	6.300

PLASTİK SIRA KLEMENS (YANMAZ)

Kod	Ürün Adı	Amb. Ad.	Koli	Fiyat (₺)
90 000 000 000 2105	No.1 Yanmaz Sıra Klemens 2.5-4 mm	50	1000	2.800
90 000 000 000 2106	No.2 Yanmaz Sıra Klemens 4-6 mm	50	1000	3.600
90 000 000 000 2107	No.3 Yanmaz Sıra Klemens 10-16 mm	50	500	4.300
90 000 000 000 2108	No.4 Yanmaz Sıra Klemens 16-25 mm	50	500	6.300
90 000 000 000 2110	No.5 Yanmaz Sıra Klemens 16-25 mm	50	500	7.300

DUYLAR VE TİJ AKSAMLARI

Kod	Ürün Adı	Amb. Ad.	Koli	Fiyat (₺)
90 000 000 000 1401	Tms Tipi Tekli Soket	50	500	2.800
90 000 000 000 1402	Tms Tipi Çiftli Soket	25	250	4.950
90 000 000 000 1403	Tms Tipi Starter Yuvası	50	500	0.680
90 000 000 000 1404	Simit Florasan Ayak	250	5000	0.077
90 000 000 000 1405	Küp Simit Soket	50	500	1.700
90 000 000 000 1406	Starter Yuvalı Simit Soket	50	500	1.700
90 000 000 000 1407	Porselen Duylu Tij Askı Takımı	35	280	2.800
90 000 000 000 1408	Duysuz Tij + Rozans Takımı	1000	1000	0.890
90 000 000 000 1409	Tij Rozans	1000	1000	0.290
90 000 000 000 1411	Starter	25	2000	1.500
90 000 000 000 1412	Fantasy Porselen Duylu Tij Askı Takımı	25	200	3.250
90 000 000 000 1414	T8 Ampul Tutucu	100	5000	0.195
90 000 000 000 1415	T5 Ampul Tutucu	100	5000	0.195
90 000 000 000 1416	T8 Reklam Duy	100	500	1.090
90 000 000 000 1418	T5 Reklam Duy	100	500	1.090
90 000 000 000 1419	T8 Florasan Duy	50	500	0.620
90 000 000 000 1420	T8 Florasan Duy ( Yaylı)	50	500	0.790
90 000 000 000 1421	T8 Florasan Duy ( Yatay)	50	500	0.690
90 000 000 000 1422	Kamçı	50	500	0.110
90 000 000 000 1423	Kablo Tutucu	50	500	0.035
90 000 000 000 1424	Mesafe Takozu	50	500	0.069

**PAPATYA - DAMLA ASKI TİJLİ ARMATÜRLER (E-27)**



Kod	Ürün Adı	Amb. Ad.	Koli Ad.	Fiyat (₺)
20 025 000 000 01302	Papatya Askı Tij Armatür (Şeffaf)	4	32	9.75
20 025 000 000 01303	Papatya Askı Tij Armatür (Parlament Mavi)	4	32	9.75
20 025 000 000 01304	Papatya Askı Tij Armatür (Yeşil)	4	32	9.75
20 025 000 000 01305	Papatya Askı Tij Armatür (Füme)	4	32	9.75
20 025 000 000 01307	Damla Askı Tij Armatür (Şeffaf)	4	32	9.75
20 025 000 000 01308	Damla Askı Tij Armatür (Mavi)	4	32	9.75
20 025 000 000 01309	Damla Askı Tij Armatür (Pembe)	4	32	9.75



# SERTİFİKALAR





**İŞILDAR**<sup>®</sup>  
LIGHTING SYSTEM

**İşıldar Plastik ve Aydınlatma A.Ş.**

İkitelli Organize Sanayi Bölgesi İpkas San Sitesi 3. Etap B Blok No: 9

İkitelli / Başakşehir / İstanbul - TURKEY

T: +90 212 549 52 93 (pbx) F: +90 212 549 53 96

[www.isildar.eu](http://www.isildar.eu) • [info@isildar.eu](mailto:info@isildar.eu)