

## FIYAT LİSTESİ: 2017 ŞUBAT



**Pelsan**

6	Slim LED Panel Ofis Armatürleri	
8	Sıva Altı Backlight Ofis Armatürleri	
11	Sıva Üstü Backlight Ofis Armatürleri	
12	Sıva Altı & Üstü Ofis Armatürleri	
14	Sıva Altı Mimari Ofis Armatürleri	
15	Steril Ortam ve Hastane Armatürleri	
16	Recta Linear Armatürler	
17	Mimari Sarkıt & Sıva Üstü Armatürler	
18	Dekoratif Sarkıt Armatürler	
20	Sıva Altı Slim LED Downlight Armatürler	
21	Sıva Altı & Sıva Üstü Slim LED Downlight Armatürler	
22	Sıva Altı Backlight LED Downlight Armatürler	
24	LED Spot Armatürler	
25	LED Ray Spotlar	

26	LED Aplikler			
27	LED Tavan Armatürleri			
28	IP66 Tavan Armatürü			
29	IP66/44 Tavan & Duvar Armatürleri			
30	Sensörler			
32	Sensörlü Armatürler			
33	Bant Armatürler			
34	Bant Armatürler			
36	Etanj Armatürler			
38	Acil Aydınlatma Armatürleri			
40	Acil Yönlendirme Armatürleri			
42	Okul Armatürleri			
43	Atölye Armatürleri			
44	Yüksek Tavan Armatürleri			

46	Benzinlik Armatürler	
47	Exproof Armatürler	
48	Wallwasherlar	
50	LED Projektörler	
54	Projektörler	
56	LED Yol Aydınlatma Armatürleri	
58	Yol Aydınlatma Armatürleri	
61	Park Bahçe Aydınlatma Armatürleri	
63	LED Park Bahçe Direkleri	
69	Park Bahçe Direkleri	
70	Takım Park Bahçe Armatürleri	
72	Çimen Armatürleri	
73	Aplık ve Set Üstü Armatürleri	

74	Duvar Gömme ve Havuz Armatürleri			
75	Yer Gömme Armatürleri			
76	Lambalar			
80	LED Şerit ve Sürücüleri			
81	LED Bar ve Sürücüleri			
82	Sabit Gerilim Sürücüleri			
83	Balast ve Konverter Kitler			
84	Komponentler			
85	Panolar			
86	Anahtar ve Prizler			
95	Grup Prizler			
98	Fırsat Ürünleri			
101	Kod İndeks	01100111 11111100 11100010 10011100 11001011 01001001 00100011 00011111 10111001 01010010 00100011 11010010	01100111 11111100 11100010 10011100 11001011 01001001 00100011 00011111 10111001 01010010 00100011 11010010	01100111 11111100 11100010 10011100 11001011 01001001 00100011 00011111 10111001 01010010 00100011 11010010

# Pelsan Slim LED Panel Ofis Armatürleri

## Mioled 36W 60x60 S.A

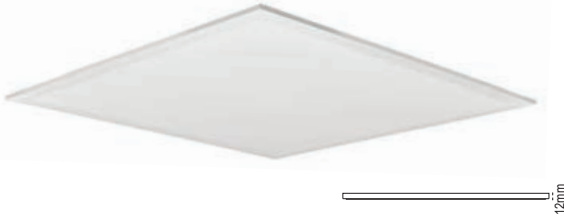

IP 40

kod no	özellikler	koli adedi	fiyat
5615 8160	Mioled 36W 60X60 4000K	5	43,40 \$
5615 8170	Mioled 36W 60X60 6500K	5	43,40 \$

## Mioled 36W 60x60 Clip-in

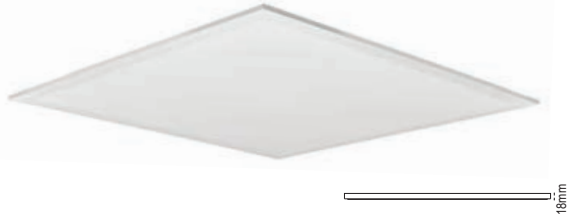

IP 40

kod no	özellikler	koli adedi	fiyat
5615 8380	Mioled 36W 60X60 4000K Clip-in	5	45,20 \$
5615 8390	Mioled 36W 60X60 6500K Clip-in	5	45,20 \$

## Mioled 20W 30x30 S.A



IP40

kod no	özellikler	koli adedi	fiyat
5615 8200	Mioled 20W 30X30 4000K	20	22,60 \$
5615 8220	Mioled 20W 30X30 6500K	20	22,60 \$

## Mioled 20W 30x30 Clip-in



IP40

kod no	özellikler	koli adedi	fiyat
5615 8450	Mioled 20W 30x30 4000K Clip-in	20	24,50 \$
5615 8460	Mioled 20W 30x30 6500K Clip-in	20	24,50 \$

## Mioled 36W 30x60 S.A

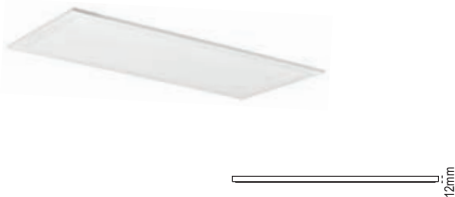

IP 40

kod no	özellikler	koli adedi	fiyat
5615 8190	Mioled 30W 30X60 4000K	10	45,25 \$
5615 8240	Mioled 30W 30X60 6500K	10	45,25 \$

## Mioled 40W 30x120 S.A

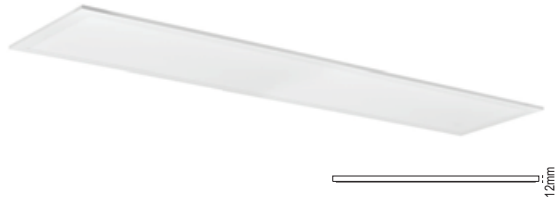

IP 40

kod no	özellikler	koli adedi	fiyat
5615 8180	Mioled 40W 30X120 4000K	10	69,75 \$
5615 8260	Mioled 40W 30X120 6500K	10	69,75 \$

## Panel Acil Aydınlatma Kiti



kod no	özellikler	fiyat
5913 1470	Panel Acil Ayd. Kiti (Tüm Paneller ile uyumlu)	52,60 \$

## Panel Aparatları



kod no	özellikler	koli adedi	fiyat
5985 5710	Askı Aksesuarı ( 4 Adet)	1	5,20 \$
5985 5730	Alçıpan Aksesuar Takımı( 4 adet)	1	3,00 \$

## Mioled Performans

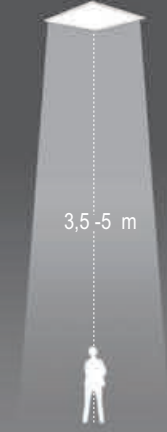

**110 lm/W**

### Yüksek Tavanlar için

- Mioled Performans, 3.50- 5.50 metre arasındaki tavan yüksekliğine sahip yapılarda gereken aydınlık düzeyini veren ideal bir çözümdür.
- 110 lm/W'ı aşan etkinlik faktörü ile yüksek performans sunar.

IP40

kod no	özellikler	koli adedi	fiyat
5615 9950	Mioled Performans 36W 60X60 4000K	5	85,00 \$
5615 9960	Mioled Performans 36W 60X60 6500K	5	85,00 \$

## Mioled Konfor

**UGR<19**



12mm

### Yüksek Göz Konforu için

- Mioled Konfor, özel difüzör ve LED çipleri sayesinde kamaşmayı engelleyerek işinize odaklanmanızı sağlar.

IP 40

kod no	özellikler	koli adedi	fiyat
5615 9980	Mioled Konfor 36W 60X60 4000K	5	85,00 \$
5615 9990	Mioled Konfor 36W 60X60 6500K	5	85,00 \$

## Slim Panel

### S.Ü Çerçeve Aparatı



kod no	özellikler	koli adedi	fiyat
4201 085	60X60 Slim Panel S.U. Çerçeve Aparatı	5	10,90 \$
4201 086	30X30 Slim Panel S.U. Çerçeve Aparatı	5	6,60 \$
4201 087	30X60 Slim Panel S.U. Çerçeve Aparatı	5	7,70 \$
4201 088	30X120 Slim Panel S.U.Çerçeve Aparatı	5	10,90 \$

# Pelsan Sıva Altı Backlight Ofis Armatürleri

## Isoled

**Hem Hesaplı, Hem Tasarruflu**



Pelsan 33W 60X60 backlight LED teknolojisi ile 4x18 parabolik'e eşdeğer aydınlatma

Üstelik 3 saate kadar acil aydınlatma ünite opsiyonlu



Kredi Yurtlar Kurumu ile hastane şartnamelerine uygun



Özel projeler için özel çözüm



Clip-in uygulaması ve acil aydınlatma ünite opsiyonlu



90 lm/W'ı aşan etkinlik faktörü



Avrupa driver opsiyonlu



1-10V dim ve dali seçenekleri

## Isoled Ambiyans



- Isoled Ambiyans, özel difüzörü sayesinde farklı açılardan farklı ışık hareleri sunar. Bu özel ışık hareleri sayesinde ofisinize dinamizm katar.



Kamaşma kontrollü özel difüzör



100 lm/W'ı aşan verimlilik



Dali, 1-10V dim ve acil aydınlatma kit opsiyonu



Clip-in opsiyonu



Avrupa driver opsiyonu

**Farklı Açılardan  
Farklı Işık Hareleri  
Sunar**



IP 40 ☺

kod no	özellikler	koli adedi	fiyat
5615 2901	Isoled Ambiyans 12W 30X30 S.A. 4000 / 6500K	5	81,00 \$
5615 2921	Isoled Ambiyans 17W 30X60 S.A. 4000 / 6500K	4	98,00 \$
5615 2931	Isoled Ambiyans 33W 60X60 S.A. 4000 / 6500K	5	104,00 \$
5615 2951	Isoled Ambiyans 42W 60X60 S.A. 4000 / 6500K	5	150,00 \$
5615 2971	Isoled Ambiyans 42W 30X120 S.A. 4000 / 6500K	4	218,00 \$



**Isoled 42w**  
60x60 S.A



IP 40 



kod no	özellikler	koli adedi	fiyat
5615 8770	Isoled 42W 60X60 S.A. 4000/6500K	5	75,00 \$

**Isoled 42w**  
60x60 Clip-in



IP 40 



kod no	özellikler	koli adedi	fiyat
5615 8870	Isoled 42W 60X60 Clip-in 4000/6500K	5	76,90 \$

**Isoled 33w**  
60x60 S.A



IP 40 



kod no	özellikler	koli adedi	fiyat
5615 3011	Isoled 33W 60x60 S.A. 4000/6500K	5	52,00 \$

**Isoled 33w**  
60x60 Clip-in



IP 40 



kod no	özellikler	koli adedi	fiyat
5615 3021	Isoled 33W 60x60 S.A. Clip-in 4000/6500K	5	53,90 \$

**Isoled 12w**  
30x30 S.A



IP 40 



kod no	özellikler	koli adedi	fiyat
5615 8750	Isoled 12W 30X30 S.A. 4000/6500K	5	40,50 \$

**Isoled 12w**  
30x30 Clip-in



IP 40 



kod no	özellikler	koli adedi	fiyat
5615 8880	Isoled 12W 30X30 S.A. Clip-in 4000/6500K	5	42,40 \$

**Isoled 24w**  
30x60 S.A





IP 40 



kod no	özellikler	koli adedi	fiyat
5615 8760	Isoled 24W 30X60 S.A. 4000/6500K	4	49,00 \$

**Isoled 42w**  
30x120 S.A



IP 40 



kod no	özellikler	koli adedi	fiyat
5615 8780	Isoled 42W 30X120 S.A. 4000/6500K	4	109,00 \$

## Isoled Aksesuarı & Acil. Ayd. Kiti

kod no	özellikler	koli adedi	fiyat
3180 197	Isoled Alçıpan Yayı (4 adet)	1	3,00 \$
5913 1470	Isoled Acil Ayd. Kiti (Tüm Paneller ile uyumlu)	1	52,60 \$

# Pelsan Sıva Altı Backlight Ofis Armatürleri

## Fioled2 33w 60x60 S.A. / Clip-in



IP 40



47mm

kod no	özellikler	koli adedi	fiyat
5616 6541	Fioled2 33W 60X60 S.A.. 4000/6500K	4	75,60 \$
5616 6561	Fioled2 33W 60X60 Clip-in 4000/6500K	4	81,90 \$

## Seoled2 30w 60x60 S.A. / Clip-in



IP 40

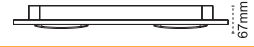

67mm

kod no	özellikler	koli adedi	fiyat
5616 6051	Seoled2 33W 60X60 S.A.. 4000/6500K	4	79,40 \$
5616 6071	Seoled2 33W 60X60 Clip-in 4000/6500K	4	85,70 \$

## Fioled3 33w 60x60 S.A. / Clip-in



IP 40

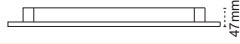

47mm

kod no	özellikler	koli adedi	fiyat
5616 6581	Fioled3 33W 60X60 S.A.. 4000/6500K	4	65,00 \$
5616 6601	Fioled3 33W 60X60 Clip-in 4000/6500K	4	74,50 \$

## Seoled3 30w 60x60 S.A. / Clip-in



IP 40



67mm

kod no	özellikler	koli adedi	fiyat
5616 6091	Seoled3 30W 60X60 S.A.. 4000/6500K	4	72,00 \$
5616 6111	Seoled3 30W 60X60 Clip-in 4000/6500K	4	78,30 \$

## Fioled1 8w 30x30 S.A. / Clip-in



IP 40



47mm

kod no	özellikler	koli adedi	fiyat
5616 6621	Fioled1 8W 30X30 S.A.. 4000/6500K	4	56,70 \$
5616 6641	Fioled1 8W 30X30 Clip-in 4000/6500K	4	63,00 \$

## Seoled1 8w 30x30 S.A. / Clip-in



IP 40



67mm

kod no	özellikler	koli adedi	fiyat
5616 6131	Seoled1 8W 30X30 S.A.. 4000/6500K	4	58,80 \$
5616 6151	Seoled1 8W 30X30 Clip-in 4000/6500K	4	65,10 \$

## Opsiyon Farkları

kod no	özellikler	koli adedi	fiyat
3180 197	Alçıpan yayı (4 adet)	1	3,00\$

kod no	özellikler	koli adedi	fiyat
5913 1470	Seoled-Fioled Acil Ayd. Kiti	1	52,60\$

# Sıva Üstü Backlight Ofis Armatürleri

## Dekaled



axbxcm  
 .....12W:330x330x53  
 .....17W:630x330x53  
 .....33/42W:630x630x53  
 .....33W:1230x330x53



kod no	özellikler	koli adedi	fiyat
5615 3191	Dekaled 12W 30X30 S.U. 4000/6500K	4	55,50 \$
5615 3171	Dekaled 17W 30X60 S.U. 4000/6500K	4	59,90 \$
5615 3111	Dekaled 33W 60X60 S.U. 4000/6500K	5	65,60 \$
5615 3131	Dekaled 42W 60X60 S.U. 4000/6500K	5	92,90 \$
5615 3141	Dekaled 33W 30X120 S.U. 4000/6500K	4	83,90 \$

## Dekoled



IP 40



kod no	özellikler	koli adedi	fiyat
5615 8650	Dekoled 12W 30X30 S.U. 4000/6500K	5	46,20 \$
5615 8660	Dekoled 24W 30X60 S.U. 4000/6500K	5	49,90 \$
5615 8670	Dekoled 33W 60X60 S.U. 4000/6500K	5	54,70 \$
5615 8641	Dekoled 42W 60X60 S.U. 4000/6500K	5	77,30 \$
5615 8680	Dekoled 42W 30X120 S.U. 4000/6500K	4	77,30 \$

## Fioled 3

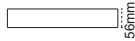

P 40

kod no	özellikler	koli adedi	fiyat
5616 6591	Fioled3 33W 60X60 S.U. 4000/6500K	4	77,70 \$

## Seoled 3



P 40

kod no	özellikler	koli adedi	fiyat
5616 6101	Seoled3 30W 60X60 S.U. 4000/6500K	4	81,50 \$

## Fioled 1

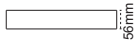

P 40

kod no	özellikler	koli adedi	fiyat
5616 6631	Fioled1 8W 30X30 S.U. 4000/6500K	4	61,90 \$
5616 6671	Fioled1 17W 30X60 S.U. 4000/6500K	4	66,10 \$
5616 6511	Fioled1 33W 60X60 S.U. 4000/6500K	4	94,50 \$
5616 6711	Fioled1 30W 30X120 S.U. 4000/6500K	4	124,00 \$

## Seoled 1



P 40

kod no	özellikler	koli adedi	fiyat
5616 6141	Seoled1 8W 30X30 S.U. 4000/6500K	4	64,00 \$
5616 6181	Seoled1 17W 30X60 S.U. 4000/6500K	4	68,20 \$
5616 6021	Seoled1 33W 60X60 S.U. 4000/6500K	4	98,30 \$
5616 6221	Seoled1 30W 30X120 S.U. 4000/6500K	4	127,70 \$

## Opsiyon Farkları

kod no	özellikler	koli adedi	fiyat
5913 1470	Sıva Üstü Panel Acil Aydınlatma Kiti	1	52,60 \$

### 7 Lamel Çift Parabolik



IP 20

özellikler	koli adedi	mek. bal. kod no	fiyat	elk. bal. kod no	fiyat
2X18W TLD	4	5014 4761	72,70 ₺	5014 4762	112,20 ₺
4X18W TLD	4	5014 4771	103,55 ₺	5014 4772	127,55 ₺
2X36W TLD	4	5014 4781	103,55 ₺	5014 4782	127,55 ₺
4X36W TLD	2	5014 4791	223,45 ₺	5014 4792	305,70 ₺

### Isolamp T8



IP 20

özellikler	koli adedi	mek. bal. kod no	fiyat	elk. bal. kod no	fiyat
2X18W TLD	4	5014 4711	78,15 ₺	5014 4712	126,55 ₺
4X18W TLD	4	5014 4741	116,15 ₺	5014 4742	140,40 ₺
2X36W TLD	4	5014 4731	116,15 ₺	5014 4732	140,40 ₺
4X36W TLD	2	5014 4751	255,75 ₺	5014 4752	334,10 ₺

### Prizmatik Lensli

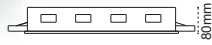

IP 40

özellikler	koli adedi	mek. bal. kod no	fiyat	elk. bal. kod no	fiyat
2X18W TLD	4	5014 1911	75,25 ₺	5014 1912	112,20 ₺
4X18W TLD	4	5014 1921	108,80 ₺	5014 1922	127,55 ₺
2X36W TLD	4	5014 1931	108,80 ₺	5014 1932	127,55 ₺
4X36W TLD	2	5014 1941	230,10 ₺	5014 1942	305,70 ₺

### Opal Lensli

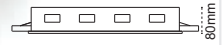

IP 40

özellikler	koli adedi	mek. bal. kod no	fiyat	elk. bal. kod no	fiyat
2X18W TLD	4	5014 6011	80,40 ₺	5014 6012	117,35 ₺
4X18W TLD	4	5014 6021	121,25 ₺	5014 6022	140,40 ₺
2X36W TLD	4	5014 6031	121,25 ₺	5014 6032	140,40 ₺
4X36W TLD	2	5014 6041	262,75 ₺	5014 6042	338,10 ₺

### Isolamp T5



IP 20

kod no	özellikler	koli adedi	fiyat
5014 4022	2X14W T5 Elk. Bal. S.A.	6	125,20 ₺
5014 4032	3X14W T5 Elk. Bal. S.A.	6	145,40 ₺
5014 4042	4X14W T5 Elk. Bal. S.A.	6	145,40 ₺
5014 4212	2X28W T5 Elk. Bal. S.A.	4	145,40 ₺
5014 4222	3X28W T5 Elk. Bal. S.A.	2	383,95 ₺
5014 4232	4X28W T5 Elk. Bal. S.A.	2	383,95 ₺

### Luxlamp T5



IP 20

kod no	özellikler	koli adedi	fiyat
5011 1462	2X14W T5 Elk. Bal. S.A.	6	140,20 ₺
5011 1482	4X14W T5 Elk. Bal. S.A.	6	152,85 ₺
5011 1432	2X28W T5 Elk. Bal. S.A.	4	152,85 ₺

### Endirekt 1XPerfore

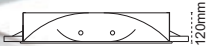

IP 20

kod no	özellikler	koli adedi	fiyat
5011 1452	4X28W T5 Elk. Bal. S.A.	3	355,55 ₺
5014 8532	2X24W T5 Elk. Bal. S.A.	3	191,90 ₺

### Isolamp T5 Clip-in



IP 20

kod no	özellikler	koli adedi	fiyat
5014 6612	2X14W T5 Elk. Bal. Clip-in	6	129,00 ₺
5014 6502	4X14W T5 Elk. Bal. Clip-in	6	153,10 ₺

## Dekolamp



IP 20 ☺



50mm

kod no	özellikler	koli adedi	fiyat
5014 7252	2X18W TLD Elk. Bal. S.U.	6	114,20 ₺
5014 7262	4X18W TLD Elk. Bal. S.U.	6	129,25 ₺
5014 7272	2X36W TLD Elk. Bal. S.U.	4	129,25 ₺
5014 7282	4X36W TLD Elk. Bal. S.U.	2	308,65 ₺

## Dekolamp Endirekt Perfore



IP 20 ☺

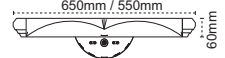

60mm

kod no	özellikler	koli adedi	fiyat
5014 9882	2X24W T5 Elk. Bal. S.U.	3	214,30 ₺
5014 9892	3X24W T5 Elk. Bal. S.U.	3	228,35 ₺

## Dekolamp Prizmatik Lensli



IP 40 ☺



50mm

kod no	özellikler	koli adedi	fiyat
5014 4552	2X18W TLD Elk. Bal. S.U.	6	114,20 ₺
5014 4562	4X18W TLD Elk. Bal. S.U.	6	141,90 ₺
5014 4572	2X36W TLD Elk. Bal. S.U.	4	141,90 ₺
5014 4582	4X36W TLD Elk. Bal. S.U.	2	310,00 ₺

## Dekolamp Opal Lensli



IP 40 ☺



50mm

kod no	özellikler	koli adedi	fiyat
5014 7382	2X18W TLD Elk. Bal. S.U.	6	118,15 ₺
5014 7392	4X18W TLD Elk. Bal. S.U.	6	137,05 ₺
5014 7402	2X36W TLD Elk. Bal. S.U.	4	137,05 ₺
5014 7412	4X36W TLD Elk. Bal. S.U.	2	323,85 ₺

## Dekolamp1 T5



IP 20 ☺



50mm

kod no	özellikler	koli adedi	fiyat
5014 5562	2X14W T5 Elk. Bal. S.U.	6	126,85 ₺
5014 5582	4X14W T5 Elk. Bal. S.U.	6	147,10 ₺
5014 5602	2X28W T5 Elk. Bal. S.U.	4	147,10 ₺
5014 5622	4X28W T5 Elk. Bal. S.U.	2	387,40 ₺

## Luxlamp T5



IP 20 ☺



35mm

kod no	özellikler	koli adedi	fiyat
5011 1522	2X14W T5 Elk. Bal. S.U.	6	141,00 ₺
5011 1492	4X14W T5 Elk. Bal. S.U.	6	155,10 ₺
5011 1532	2X28W T5 Elk. Bal. S.U.	4	155,10 ₺
5011 1502	4X28W T5 Elk. Bal. S.U.	2	387,00 ₺

## Dekolamp-2



IP 20 ☺



50mm

kod no	özellikler	koli adedi	fiyat
5014 4182	2X28W T5 Elk. Bal. S.U.	4	211,40 ₺
5014 9982	2X35W T5 Elk. Bal. S.U.	4	253,65 ₺
3220 335	Askı Takımı 150cm (4adet)	1	13,60 \$

## Birlamp



IP 20 ☺



35mm

kod no	özellikler	koli adedi	fiyat
5014 8852	2X14W T5 Elk. Bal. S.U.	6	176,20 ₺
5014 8872	2X28W T5 Elk. Bal. S.U.	6	211,40 ₺
5014 8892	2X35W T5 Elk. Bal. S.U.	6	281,80 ₺
3220 326	Askı Takımı 100cm (4adet)	1	10,60 \$

**Halley LED**  
60x60 S.A

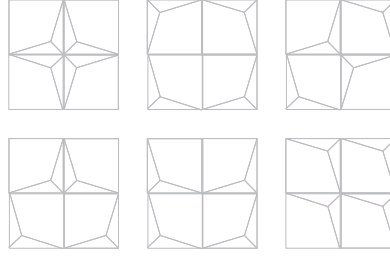

4'li kullanım önerisi



IP 40 ☺

kod no özellikler  
5615 9241 Halley 4X33W 60x60 S.A. 4000/6500K (4'lü set)

koli adedi fiyat  
4 462,00 \$

**Galaxy LED**  
60x60 S.A

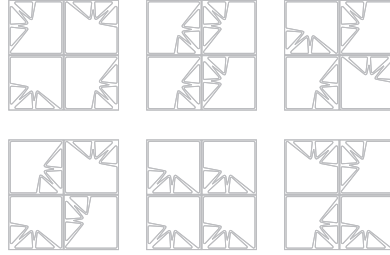

4'li kullanım önerisi

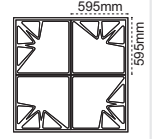

IP 40 ☺

kod no özellikler  
5615 9261 Galaxy 4X33W 60x60 S.A. 4000/6500K (4'lü set)

koli adedi fiyat  
4 420,00 \$

**Cion LED**  
60x60 S.A

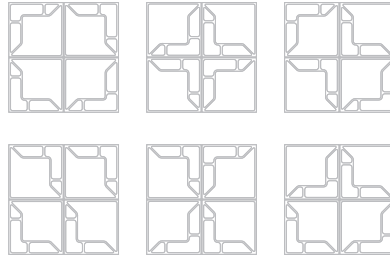

4'li kullanım önerisi

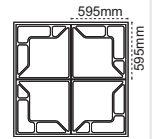

IP 40 ☺

kod no özellikler  
5615 9251 Cion 4X33W 60x60 S.A. 4000/6500K (4'lü set)

koli adedi fiyat  
4 420,00 \$

**Gupur LED**  
60x60 S.A

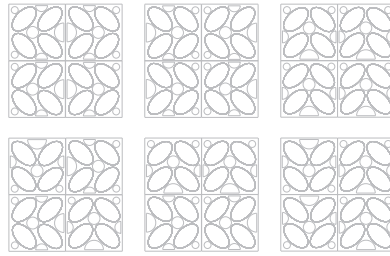
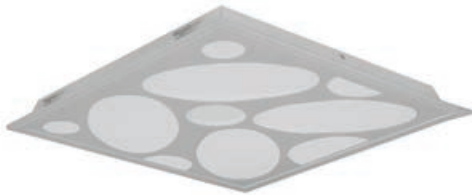

4'li kullanım önerisi

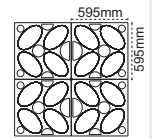

IP 40 ☺

kod no özellikler  
5615 9141 Gupur 33W 60x60 S.A. 4000/6500K

koli adedi fiyat  
4 105,00 \$

## IP65 LED Steril S.A.



IP 65

kod no	özellikler	koli adedi	fiyat
5615 8811	LED Steril IP65 33W 60x60 S.A. 4000/6500K	4	550,80 ₺

## IP65 LED Steril S.U.



IP 65

kod no	özellikler	koli adedi	fiyat
5615 8001	LED Steril IP65 33W 60x60 S.U. 4000/6500K	4	576,40 ₺

## IP65 Steril S.A Temperli kumlu camlı



IP 65

kod no	özellikler	koli adedi	fiyat
5014 2912	2X18W TLD Elk. Bal. S.A.	4	230,60 ₺
5014 2922	4X18W TLD Elk. Bal. S.A.	3	275,40 ₺
5014 2932	2X36W TLD Elk. Bal. S.A.	3	288,20 ₺
5011 1002	2X14W T5 Elk. Bal. S.A.	4	234,40 ₺
5011 0842	4X14W T5 Elk. Bal. S.A.	3	279,30 ₺
5011 0832	2X28W T5 Elk. Bal. S.A.	3	292,10 ₺

## IP65 Steril S.Ü Temperli kumlu camlı



IP 65

kod no	özellikler	koli adedi	fiyat
5014 2812	2X18W TLD Elk. Bal. S.U.	4	249,70 ₺
5014 2822	4X18W TLD Elk. Bal. S.U.	4	301,00 ₺
5014 2832	2X36W TLD Elk. Bal. S.U.	4	313,80 ₺
5014 2862	2X14W T5 Elk. Bal. S.U.	4	253,70 ₺
5014 5342	4X14W T5 Elk. Bal. S.U.	4	304,90 ₺
5014 5142	2X28W T5 Elk. Bal. S.U.	4	317,80 ₺

## IP65 Steril S.A. Temperli Camlı



IP 65

kod no	özellikler	koli adedi	fiyat
5014 5162	2X18W TLD Elk. Bal. S.A.	4	249,70 ₺
5014 5132	4X18W TLD Elk. Bal. S.A.	3	307,50 ₺
5014 5172	2X36W TLD Elk. Bal. S.A.	3	320,30 ₺

## IP65 Steril S.U. Temperli Camlı



IP 65

kod no	özellikler	koli adedi	fiyat
5014 4402	2X18W TLD Elk. Bal. S.U.	4	269,10 ₺
5014 4412	4X18W TLD Elk. Bal. S.U.	4	333,10 ₺
5014 4422	2X36W TLD Elk. Bal. S.U.	4	345,90 ₺

## Mikrop Kırıcı



IP 20

kod no	özellikler	koli adedi	fiyat
5014 4482	1X15W TLD Elk. Bal. S.U.	1	125,00 ₺
5014 4492	1X30W TLD Elk. Bal. S.U.	1	140,00 ₺

## Negatoskop



IP 40

kod no	özellikler	koli adedi	fiyat
5615 8540	Negatoskop 42W LED 60X60	1	152,30 \$
5615 8550	Negatoskop 84W LED 60X120	1	210,10 \$
5014 7202	Negatoskop 2X14W T5 Elk. Bal.	1	245,00 ₺
5014 7222	Negatoskop 4X18W TLD Elk. Bal.	1	255,00 ₺

**3 Metreye Kadar  
Kesintisiz Gövde  
Seçeneği**

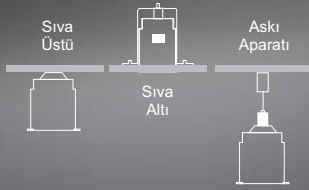
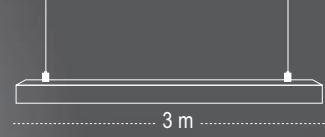

### Recta LED Sıva Üstü



IP 40

kod no	özellikler	a x b x c	koli adedi	fiyat
5615 9301	20W 4000/6500K	600X58X76 mm	1	56,50 \$
5615 9311	36.5W 4000/6500K	900X58X76 mm	1	85,00 \$
5615 9321	48W 4000/6500K	1200X58X76 mm	1	94,50 \$
5615 9331	61W 4000/6500K	1500X58X76 mm	1	122,50 \$
3220 326	Dekoratif Askı Aparatı 100cm		1	10,60 \$

### Recta LED Sıva Üstü



IP 40

kod no	özellikler	a x b x c	koli adedi	fiyat
5615 9491	20W 4000/6500K	600X85X76	1	56,50 \$
5615 9501	36.5W 4000/6500K	900X85X76	1	85,00 \$
5615 9511	48W 4000/6500K	1200X85X76	1	94,50 \$
5615 9521	61W 4000/6500K	1500X85X76	1	122,50 \$
3220 335	Dekoratif Askı Aparatı 150cm		1	13,50 \$

### Recta LED Sıva Altı



IP 40

kod no	özellikler	a x b x c	□ (mm)	koli adedi	fiyat
5615 9411	36.5W 4000/6500K	916X76X76	902x60	1	85,00 \$
5615 9421	48W 4000/6500K	1236X76X76	1222x60	1	94,50 \$
5615 9431	61W 4000/6500K	1526X76X76	1512x60	1	122,50 \$

### Recta LED Sıva Altı



IP 40

kod no	özellikler	a x b x c	□ (mm)	koli adedi	fiyat
5615 9601	36.5W 4000/6500K	916X108X76	902x87	1	85,00 \$
5615 9611	48W 4000/6500K	1236X108X76	1222x87	1	94,50 \$
5615 9621	61W 4000/6500K	1526X108X76	1512x87	1	122,50 \$





### Quad LED

IP 40 

kod no	özellikler	koli adedi	fiyat
5615 9291	20W 4000/6500K	1	180,00 \$
5615 9341	75W 4000/6500K	1	245,00 \$
5615 9391	100W 4000/6500K	1	300,00 \$

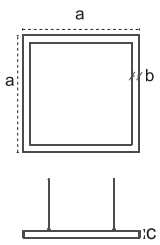

	axbxcmm
20W	400x57x100
75W	600x57x100
100W	900x57x100

### Polaris LED

IP 40 

kod no	özellikler	koli adedi	fiyat
5615 6171	20W 4000/6500K	1	200,00 \$
5615 6181	75W 4000/6500K	1	265,00 \$
5615 9391	100W 4000/6500K	1	365,00 \$

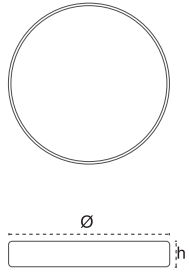

	Øxhmm
20W	400x100
75W	600x100
100W	900x100

### Circa LED

IP 40 

kod no	özellikler	koli adedi	fiyat
5615 6221	75W 4000/6500K	1	365,00 \$
5615 6131	100W 4000/6500K	1	495,00 \$

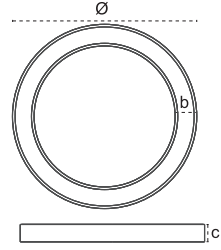

	Øxbxcmm
20W	400x74x100
75W	600x74x100
100W	900x74x100

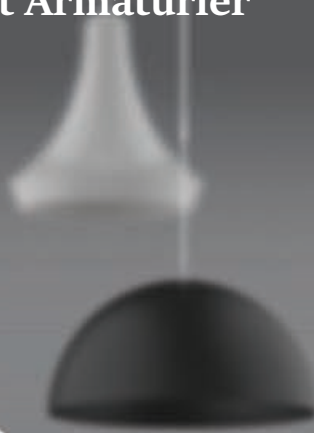

### Volga



IP 40

kod no	özellikler	koli adedi	fiyat
5616 4751	Volga 50W LED Gümüş	6	75,40 \$
5616 4741	Volga 50W LED Beyaz	6	75,40 \$
5616 4791	Volga 50W LED Altın	6	75,40 \$
5212 4011	Volga E27 Gümüş	6	37,80 \$
5212 4021	Volga E27 Beyaz	6	37,80 \$
5212 4061	Volga E27 Altın	6	37,80 \$

### Rodos



IP 20

kod no	özellikler	koli adedi	fiyat
5118 4221	Rodos E27 Siyah	4	28,30 \$
5118 4211	Rodos E27 Beyaz	4	28,30 \$
5118 4241	Rodos E27 Bakır Oksit	4	28,30 \$
5118 4231	Rodos E27 Altın Oksit	4	28,30 \$

### Pico

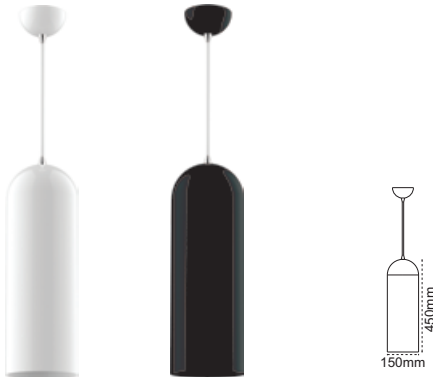

IP 20

kod no	özellikler	koli adedi	fiyat
5118 4621	Pico E27 Siyah	4	28,30 \$
5118 4611	Pico E27 Beyaz	4	28,30 \$

### Avsha



IP 20

kod no	özellikler	koli adedi	fiyat
5118 4011	Avsha E27 Siyah	4	28,30 \$
5118 4021	Avsha E27 Gri	4	28,30 \$



## LED Lambalar



kod no	özellikler	koli adedi	fiyat
5982 2050	4W 3000K E27	100	3,40 \$
5982 2090	6W E27 3000K (G125)	20	9,00 \$
5982 2070	6W E27 3000K (G64)	40	6,25 \$
5982 2080	6W E27 3000K (G95)	20	7,50 \$

## Simi

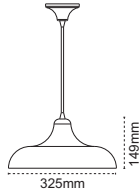

IP 20

kod no	özellikler	koli adedi	fiyat
5118 4411	Simi E27 Gri	4	28,30 \$

## Tuna / Sana

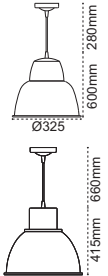

IP 20

kod no	özellikler	koli adedi	fiyat
5213 5010	Tuna E27 Q33	4	22,50 \$
5213 5110	Sana E27 Q44	4	37,00 \$

## Metal Sarkıt

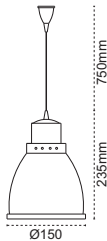

IP 20

kod no	özellikler	koli adedi	fiyat
5118 2000	Dekoratif Sarkıt E27 Q15	1	25,25 \$

## Metal Sarkıt

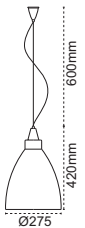

IP 20

kod no	özellikler	koli adedi	fiyat
5118 2020	Dekoratif Sarkıt E27 Q28	1	33,25 \$

# Pelsan Sıva Altı Slim LED Downlight Armatürleri



7 Farklı Güç, 7 Fark Boyut,  
Şimdi Çok Özel Fiyatlara.

Üstelik TSE Belgesi!

- 1W=1W çeker
- Pelsan Slim LED Downlightlar beyan ettiği güç ve lümeni verir.
- Alüminyum gövde, alüminyum çerçeve
- 3 saate kadar acil aydınlatma opsiyonu



Ø280

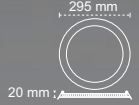

## Sırma 24W

kod no	özellikler	koli adedi	fiyat
5616 2271	24W 3000K	10	18,85 \$
5616 2261	24W 4000K	10	18,85 \$
5616 2251	24W 6500K	10	18,85 \$

## Sırma 18W



kod no	özellikler	koli adedi	fiyat
5616 2171	18W 3000K	20	8,30 \$
5616 2151	18W 4000K	20	8,30 \$
5616 2161	18W 6500K	20	8,30 \$
5616 2231	20W 6500K	20	11,20 \$

## Sırma 15W



kod no	özellikler	koli adedi	fiyat
5616 2121	15W 3000K	20	7,90 \$
5616 2141	15W 4000K	20	7,90 \$
5616 2131	15W 6500K	20	7,90 \$

## Sırma 12W



kod no	özellikler	koli adedi	fiyat
5616 2091	12W 3000K	40	6,60 \$
5616 2071	12W 4000K	40	6,60 \$
5616 2081	12W 6500K	40	6,60 \$

## Sırma 9W



kod no	özellikler	koli adedi	fiyat
5616 2101	9W 3000K	30	4,75 \$
5616 2051	9W 4000K	30	4,75 \$
5616 2061	9W 6500K	30	4,75 \$

## Sırma 6W



kod no	özellikler	koli adedi	fiyat
5616 2021	6W 3000K	100	3,80 \$
5616 2041	6W 4000K	100	3,80 \$
5616 2031	6W 6500K	100	3,80 \$

## Sırma 3W



kod no	özellikler	koli adedi	fiyat
5616 1991	3W 3000K	100	2,65 \$
5616 2001	3W 4000K	100	2,65 \$
5616 2011	3W 6500K	100	2,65 \$

## Opsiyon Farkları

kod no	özellikler	koli adedi	fiyat
5913 1470	Slim Downlight Acil Ayd. Kiti	1	52,60 \$

kod no	özellikler	koli adedi	fiyat
5918 1847	Triac DIM Driver (12W Slim Downlight için)	1	18,90 \$
5918 1848	Triac DIM Driver (15W Slim Downlight için)	1	18,90 \$
5918 1849	Triac DIM Driver (18W Slim Downlight için)	1	20,90 \$



## Sirma Çift Renkli

IP 40

Øxhmm  
3+2W: 102x29 85mm  
6+3W: 146x29 120mm

kod no	özellikler	koli adedi	fiyat
5616 1571	3+2W 6500K + mavi S.A.	20	7,00 \$
5616 1551	6+3W 6500K + mavi S.A.	20	8,50 \$



## Sirma Çift Renkli

IP 40

Øxhmm  
12+4W: 195x29 165mm  
12+4W: 195x29 -

kod no	özellikler	koli adedi	fiyat
5616 1581	12+4W 6500K + mavi S.A.	20	10,40 \$
5616 1561	12+4W 6500K + mavi S.U.	20	14,10 \$



1. kademe



2. kademe



3. kademe

## Sirma S.U. Downlight



IP 40

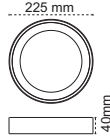

kod no	özellikler	koli adedi	fiyat
5616 1441	18W 4000K	20	16,90 \$
5616 1451	18W 6500K	20	16,90 \$

## Sirma S.U. Downlight

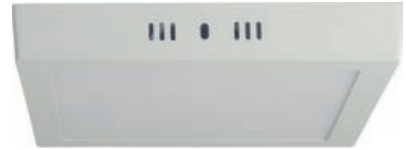

IP 40

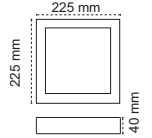

kod no	özellikler	koli adedi	fiyat
5616 1461	18W 4000K	20	16,90 \$
5616 1471	18W 6500K	20	16,90 \$

## Orion S.A.



IP 40

Øxhmm  
6W: 75 6W: 100x40  
12W: 125 12W: 160x40  
18W: 170 18W: 200x40



kod no	özellikler	koli adedi	fiyat
5616 2901	6W 6500K	20	6,70 \$
5616 2911	12W 6500K	20	11,70 \$
5616 2921	18W 6500K	20	16,70 \$

## Elektra S.A.



IP 40

axbxcmm  
6W: 75x75 6W: 100x100x40  
12W: 120x120 12W: 160x160x40  
18W: 160x160 18W: 200x200x40

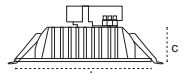

kod no	özellikler	koli adedi	fiyat
5616 2601	6W 6500K	20	6,70 \$
5616 2611	12W 6500K	20	11,70 \$
5616 2621	18W 6500K	20	16,70 \$

# Pelsan Sıva Altı Backlight LED Downlight Armatürleri

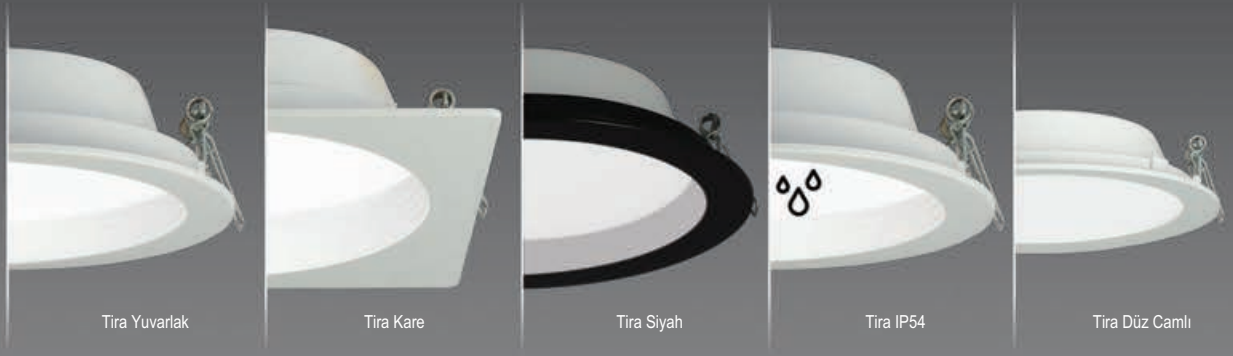

**Ofis, İş Yeri, Mağaza ve Binanıza Uygun Bir Tira Armatür Mutlaka Vardır!**

- 15-20-23,5 cm gövde çapı seçeneği
- Her gövde seçeneği için 3 çeşit güç opsiyonu
- İstenilen renk sıcaklığı uygulama opsiyonu
- Mat siyah ve beyaz çerçeve renk seçeneği
- Avrupa LED chip ve driver
- Üstelik 3 saate kadar acil aydınlatma ünite opsiyonu

## Tira Yuvarlak İçten Camlı

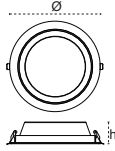

Øxhmm
7W : 148x56,5
10W : 148x56,5
15W : 197x56,5
20W : 197x56,5
25W : 233x56,5
35W : 233x56,5

IP40 ☺

kod no	özellikler	□(mm)	koli adedi	fiyat
5616 7521	7W 3000/4000K/6500K	132	20	25,50 \$
5616 7531	10W 3000/4000K/6500K	132	20	26,35 \$
5616 7551	15W 3000/4000K/6500K	185	15	33,00 \$
5616 7561	20W 3000/4000K/6500K	185	15	33,90 \$
5616 7581	25W 3000/4000K/6500K	220	10	55,80 \$
5616 7591	35W 3000/4000K/6500K	220	10	59,90 \$

## Tira Kare İçten Camlı

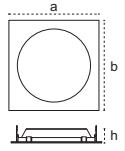

a,bxhmm
7W : 148x148x56,5
10W : 148x148x56,5
15W : 197x197x56,5
20W : 197x197x56,5
25W : 233x233x56,5
35W : 233x233x56,5

IP40 ☺

kod no	özellikler	□(mm)	koli adedi	fiyat
5616 7621	7W 3000/4000K/6500K	132	20	25,50 \$
5616 7631	10W 3000/4000K/6500K	132	20	26,35 \$
5616 7651	15W 3000/4000K/6500K	185	15	33,00 \$
5616 7661	20W 3000/4000K/6500K	185	15	33,90 \$
5616 7681	25W 3000/4000K/6500K	220	10	55,80 \$
5616 7691	35W 3000/4000K/6500K	220	10	59,90 \$

## Tira Yuvarlak Düz Camlı



Øxhmm
7W : 190x50
10W : 190x50
15W : 190x50
20W : 240x50
25W : 240x50
35W : 240x50

IP40 ☺

kod no	özellikler	□(mm)	koli adedi	fiyat
5616 8141	10W 3000/4000K/6500K	185	15	30,10 \$
5616 8151	15W 3000/4000K/6500K	185	15	31,10 \$
5616 8161	20W 3000/4000K/6500K	185	15	32,00 \$
5616 8171	20W 3000/4000K/6500K	225	10	47,80 \$
5616 8181	25W 3000/4000K/6500K	225	10	53,90 \$
5616 8191	35W 3000/4000K/6500K	225	10	58,00 \$

## Tira Yuvarlak İçten Camlı IP54

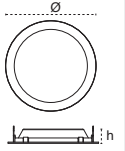

Øxhmm
7W : 148x56,5
10W : 148x56,5
15W : 197x56,5
20W : 197x56,5
25W : 233x56,5
35W : 233x56,5

IP54 ☺

kod no	özellikler	□(mm)	koli adedi	fiyat
5616 8011	7W IP54 148 x 56,5 132	132	20	31,10 \$
5616 8021	10W IP54 148 x 56,5 132	132	20	32,00 \$
5616 8031	15W IP54 148 x 56,5 132	185	15	44,30 \$
5616 8041	20W IP54 148 x 56,5 132	185	15	45,70 \$
5616 8051	25W IP54 148 x 56,5 132	220	10	66,90 \$
5616 8061	35W IP54 148 x 56,5 132	220	10	68,80 \$

## Opsiyon Farkları

kod no	özellikler	koli adedi	fiyat
5913 1470	Tira Acil Aydınlatma Kiti	1	52,60 \$

## Tira 150mm Yuvarlak İçten Camlı

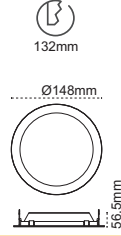

IP 40

kod no	özellikler	koli adedi	fiyat
5616 7111	5W 3000/4000/6500K	20	22,60 \$
5616 7121	7W 3000/4000/6500K	20	23,60 \$
5616 7131	10W 3000/4000/6500K	20	24,45 \$

## Tira 150mm Kare İçten Camlı

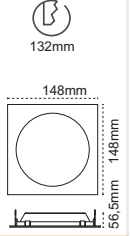

IP 40

kod no	özellikler	koli adedi	fiyat
5616 7211	5W 3000/4000/6500K	20	22,60 \$
5616 7221	7W 3000/4000/6500K	20	23,60 \$
5616 7231	10W 3000/4000/6500K	20	24,45 \$

## Tira 200mm Yuvarlak İçten Camlı

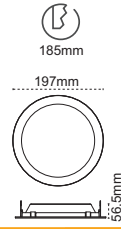

IP 40

kod no	özellikler	koli adedi	fiyat
5616 7141	10W 3000/4000/6500K	15	30,10 \$
5616 7151	15W 3000/4000/6500K	15	31,10 \$
5616 7161	20W 3000/4000/6500K	15	32,00 \$

## Tira 200mm Kare İçten Camlı

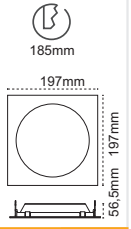

IP 40

kod no	özellikler	koli adedi	fiyat
5616 7241	10W 3000/4000/6500K	15	30,10 \$
5616 7251	15W 3000/4000/6500K	15	31,10 \$
5616 7261	20W 3000/4000/6500K	15	32,10 \$

## Tira 230mm Yuvarlak İçten Camlı

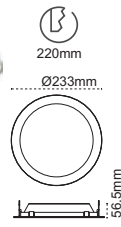

IP 40

kod no	özellikler	koli adedi	fiyat
5616 7171	20W 3000/4000/6500K	10	47,80 \$
5616 7181	25W 3000/4000/6500K	10	53,90 \$
5616 7191	35W 3000/4000/6500K	10	58,00 \$

## Tira 230mm Kare İçten Camlı

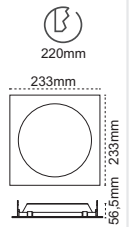

IP 40

kod no	özellikler	koli adedi	fiyat
5616 7271	20W 3000/4000/6500K	10	47,80 \$
5616 7281	25W 3000/4000/6500K	10	53,90 \$
5616 7291	35W 3000/4000/6500K	10	58,00 \$

## Opsiyon Farkları

kod no	özellikler	koli adedi	fiyat
5913 1470	TiraAcil Aydınlatma Kiti	1	52,60 \$

### Plüton Spot

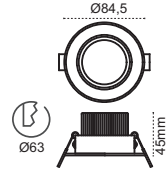

IP 40

kod no	özellikler	koli adedi	fiyat
5616 1921	5W COB LED Beyaz 6500K	100	3,80 \$
5616 1971	5W COB LED Beyaz 3000K	100	3,80 \$
5616 1981	5W COB LED Satin 6500K	100	3,80 \$
5616 1901	5W COB LED Satin 3000K	100	3,80 \$
5616 1941	5W COB LED Krom 6500K	100	3,80 \$
5616 1961	5W COB LED Krom 3000K	100	3,80 \$
5616 1891	5W COB LED Antrasit 6500K	100	3,80 \$
5616 1871	5W COB LED Antrasit 3000K	100	3,80 \$

### Sirius Galaxy Spot

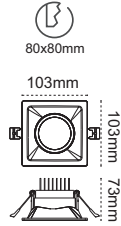

IP 40

kod no	özellikler	koli adedi	fiyat
5616 1641	8W COB LED 4000K	50	6,20 \$

### Sirius Galaxy Spot

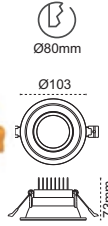

IP 40

kod no	özellikler	koli adedi	fiyat
5616 1631	8W COB LED 4000K	50	5,20 \$

### Sirius Asimetrik Spot



IP 40

kod no	özellikler	koli adedi	fiyat
5616 1661	3W COB LED 4000K	50	18,20 \$

### Sirius Star

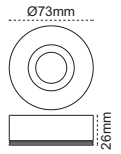

IP 40

kod no	özellikler	koli adedi	fiyat
5616 1681	5W COB LED 4000K	50	7,90 \$

### Sirius Star

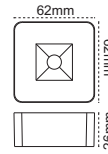

IP 40

kod no	özellikler	koli adedi	fiyat
5616 1691	5W COB LED 4000K	50	7,90 \$

### Sirius Mini

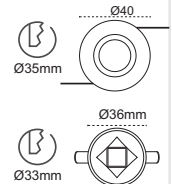

IP 40

kod no	özellikler	koli adedi	fiyat
5616 1651	3W COB LED Simetrik 4000K	50	6,70 \$
5616 1671	2W COB LED Kristal 4000K	50	7,60 \$

### Cora 5W



IP 40

kod no	özellikler	koli adedi	fiyat
5616 1711	5W COB LED 3000K	20	9,00 \$

### Cora 2x5W

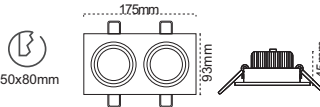

IP 40

kod no	özellikler	koli adedi	fiyat
5616 1721	2x5W COB LED 3000K	20	17,5 \$

### Cora 3x5W

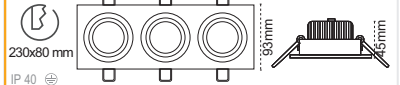

IP 40

kod no	özellikler	koli adedi	fiyat
5616 1731	3x5W COB LED 3000K	12	24,90 \$





## Lampda

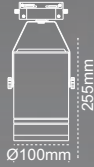

IP 20 ☺

kod no	özellikler	koli adedi	fiyat
5816 5110	20W COB LED 4000K	24	35,00 \$
5816 5120	30W COB LED 4000K	24	40,00 \$



## Theta



IP 40 ☺

kod no	özellikler	koli adedi	fiyat
5816 5210	20W COB LED 4000K	15	35,00 \$
5816 5220	30W COB LED 4000K	15	40,00 \$



## Vita

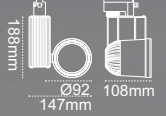

IP 40 ☺

kod no	özellikler	koli adedi	fiyat
5816 2611	20W COB LED 4000K	10	45,00 \$

## Theta



IP 40 ☺

kod no	özellikler	koli adedi	fiyat
5616 2451	23W COB LED 4000K	1	45,00 \$

## Omega



IP 40 ☺

kod no	özellikler	koli adedi	fiyat
5816 2511	10W COB LED 4000K	20	20,00 \$

## Nira



IP 40 ☺

kod no	özellikler	koli adedi	fiyat
5616 2401	30W COB LED 4000K	6	65,00 \$

## Cora 19 20W

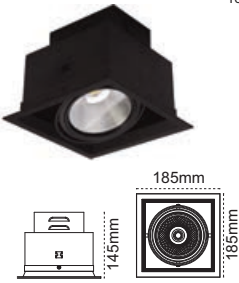

IP 40 ☺

kod no	özellikler	koli adedi	fiyat
5816 5310	20W COB LED 4000K	8	40,00 \$

## Cora 19 2X20W

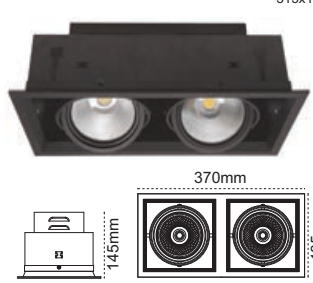

IP 40 ☺

kod no	özellikler	koli adedi	fiyat
5816 5320	2X20W COB LED 4000K	4	77,00 \$

## Cora 19 3X20W

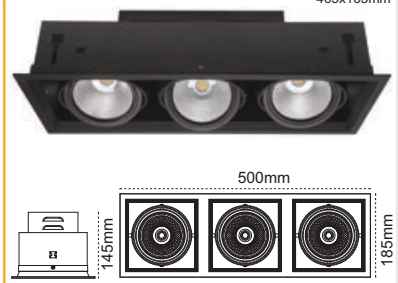

IP 40 ☺

kod no	özellikler	koli adedi	fiyat
5816 5330	3X20W COB LED 4000K	4	103,00 \$

## Ray ve Aksesuarları (Monofaze)

IP 40 ☺

3110 361

kod no	özellikler	koli adedi	fiyat	kod no	özellikler	koli adedi	fiyat	kod no	özellikler	koli adedi	fiyat
3110 356	I Birleşim Beyaz	1	2,50 \$	3110 355	T Birleşim Beyaz	1	4,25 \$	3110 351	Monofaze Ray Beyaz 1m	1	7,50 \$
3110 339	I Birleşim Siyah	1	2,50 \$	3110 365	T Birleşim Siyah	1	4,25 \$	3110 352	Monofaze Ray Beyaz 2m	1	17,00 \$
3110 354	L Birleşim Beyaz	1	3,50 \$	3110 312	Ray Adaptörü Beyaz	1	2,25 \$	3110 353	Monofaze Ray Beyaz 3m	1	23,00 \$
3110 364	L Birleşim Siyah	1	3,50 \$	3110 310	Ray Adaptörü Siyah	1	2,25 \$	3110 361	Monofaze Ray Siyah 1m	1	7,50 \$
								3110 362	Monofaze Ray Siyah 2m	1	17,00 \$
								3110 335	Monofaze Ray Siyah 3m	1	23,00 \$

**Işığı sanat için yönlendir!**



- 30.000 saat ömür
- Krom kaplı, paslanmaz gövde
- Oynar Başlık

**Guardi**  
Çift Kademeli Anahtarlı

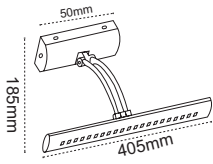

IP 20

kod no	özellikler	koli adedi	fiyat
5732 6020	7W Tablo Apliği 4000K	10	22,60 \$

**Da Vinci**

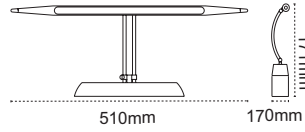

IP 20

kod no	özellikler	koli adedi	fiyat
5812 3120	5W Tablo Apliği 4000K	10	26,40 \$

**Maris**

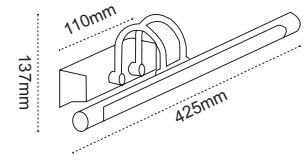

IP 20

kod no	özellikler	koli adedi	fiyat
5732 6010	5W Tablo Apliği 4000K	10	26,40 \$

**Dali**  
Anahtarlı

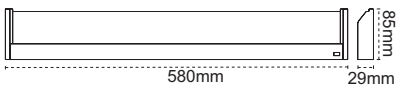

IP 20

kod no	özellikler	koli adedi	fiyat
5812 3420	6W Duvar Apliği 4000K	10	23,60 \$

**Vien**  
Anahtarlı

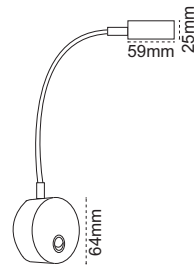

IP 20

kod no	özellikler	koli adedi	fiyat
5812 6420	3W 4000K	30	11,30 \$

**Viteri**  
Anahtarlı

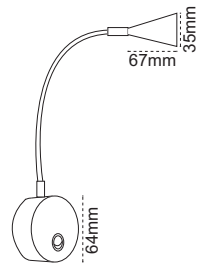

IP 20

kod no	özellikler	koli adedi	fiyat
5812 6410	3W 4000K	30	11,30 \$

## Opal 35cm



IP 40 ⊕

kod no	özellikler	koli adedi	fiyat
5613 1100	Opal LED 23W 6500K	16	24,50 \$

## Opal 35x35cm



IP 40 ⊕

kod no	özellikler	koli adedi	fiyat
5613 1251	Opal LED 23W 6500K	16	24,50 \$

## Pio1 25cm



IP 40 ⊕

kod no	özellikler	koli adedi	fiyat
5613 1361	PIO 1 LED 12W 6500K	10	15,00 \$

## Pio1 25x25cm



IP 40 ⊕

kod no	özellikler	koli adedi	fiyat
5613 1311	PIO 1 LED 12W 6500K	10	15,00 \$

## Pio2 25cm



IP 40 ⊕

kod no	özellikler	koli adedi	fiyat
5613 1371	PIO 2 LED 12W 6500K	10	15,00 \$

## Pio2 25X25cm



IP 40 ⊕

kod no	özellikler	koli adedi	fiyat
5613 1321	PIO 2 LED 12W 6500K	10	15,00 \$

## Cemre



IP 40 ⊕

kod no	özellikler	koli adedi	fiyat
5613 1011	Cemre LED 23W 6500K	10	18,90 \$

## İlkbahar



IP 40 ⊕

kod no	özellikler	koli adedi	fiyat
5612 1101	İlkbahar LED 23W 6500K	10	18,90 \$

## Planet



IP 40 ⊕

kod no	özellikler	koli adedi	fiyat
5610 3011	Planet LED 23W 6500K	6	47,00 \$

## Popart

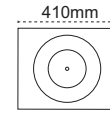
IP 40 ⊕

kod no	özellikler	koli adedi	fiyat
5610 4011	Popart LED 23W 6500K	6	47,00 \$

## Sipahi

IP 40 ⊕

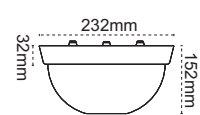
kod no	özellikler	koli adedi	fiyat
5413 1030	Sipahi E27	24	3,20 \$

## Samsun



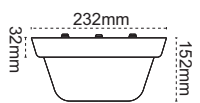

IP 40 ⊕

kod no	özellikler	koli adedi	fiyat
5413 1100	Samsun E27	24	3,50 \$
5413 1251	Samsun LED 12W 6500K	24	13,10 \$

# Pelsan IP66/44 Tavan & Duvar Armatürleri

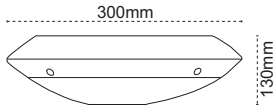
## IP66 Armada



IP 66

kod no	özellikler	koli adedi	fiyat
5812 6710	Armada Gri E27	8	13,10 \$

## IP44 Oval Kafes 21 Alüminyum Enjeksiyon

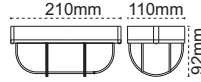

IP 44

kod no	özellikler	koli adedi	fiyat
5730 6050	Oval Kafes 21 Gri E27	18	7,00 \$

## IP44 Oval Kafes 28 Alüminyum Enjeksiyon

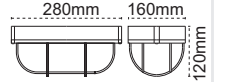

IP 44

kod no	özellikler	koli adedi	fiyat
5730 6120	Oval Kafes 28 Gri E27	12	12,60 \$

## IP44 Oval Kep Alüminyum Enjeksiyon

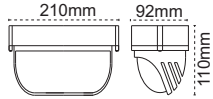

IP 44

kod no	özellikler	koli adedi	fiyat
5730 6060	Oval Kep Gri E27	18	7,00 \$

## IP44 Oval Glas Alüminyum Enjeksiyon

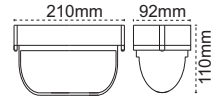

IP 44

kod no	özellikler	koli adedi	fiyat
5730 6040	Oval Glas Gri E27	18	7,00 \$

## IP44 Polo2 Alüminyum Enjeksiyon

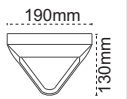

IP 44

kod no	özellikler	koli adedi	fiyat
5730 5510	Polo 2 Gri E27	8	18,90 \$

## IP44 Yaka 20 Alüminyum Enjeksiyon

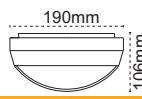

IP 44

kod no	özellikler	koli adedi	fiyat
5730 5130	Yaka 20 Gri E27	16	10,80 \$

## IP44 Yaka 26 Alüminyum Enjeksiyon

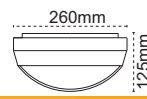

IP 44

kod no	özellikler	koli adedi	fiyat
5730 5180	Yaka 26 Gri E27	6	15,75 \$

## IP44 Polo4 Alüminyum Enjeksiyon

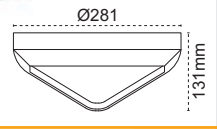

IP 44

kod no	özellikler	koli adedi	fiyat
5730 5550	Polo 4 Gri E27	8	18,90 \$

# IP66 Tavan Armatürü

## Toz ve Su Almaz

### Havana IP66

- Pelsan Havana Tavan Armatürü IP 66 koruma sınıfı ile çevre şartlarından etkilenmez.
- Darbe dayanımı yüksektir. Kırılmaz.
- E27, LED, LED Radar sensörlü, LED acil ayd. kitli.
- Paslanmaz vida ve UV ışınları ile sararmaz opal cam.



### Havana IP66 Gri

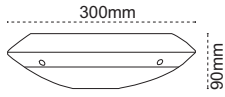

kod no	özellikler	koli adedi	fiyat
5610 6610	E27 max 23W	8	13,10 \$
5610 6620	15W LED	8	28,30 \$
5610 6630	15W LED Radar Sens.	8	47,10 \$
5610 6624	15W LED Acil Ayd. Kitli	8	56,60 \$

### Havana IP66 Siyah

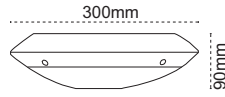

kod no	özellikler	koli adedi	fiyat
5610 6612	E27 max 23W	8	13,10 \$
5610 6621	15W LED	8	28,30 \$
5610 6631	15W LED Radar Sens.	8	47,10 \$
5610 6625	15W LED Acil Ayd. Kitli	8	56,60 \$

### Havana IP66 Beyaz

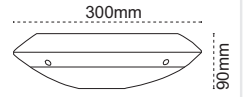

kod no	özellikler	koli adedi	fiyat
5610 6611	E27 max 23W	8	13,10 \$
5610 6622	15W LED	8	28,30 \$
5610 6632	15W LED Radar Sens.	8	47,10 \$
5610 6626	15W LED Acil Ayd. Kitli	8	56,60 \$

## Renk Opsiyonları



### Gri / Kırmızı

kod no	özellikler	koli adedi	fiyat
5610 6613	E27 max 23W	8	15,00 \$



### Gri / Turuncu

kod no	özellikler	koli adedi	fiyat
5610 6614	E27 max 23W	8	15,00 \$



### Gri / Mavi

kod no	özellikler	koli adedi	fiyat
5610 6615	E27 max 23W	8	15,00 \$

### 360° Hareket Sensörü

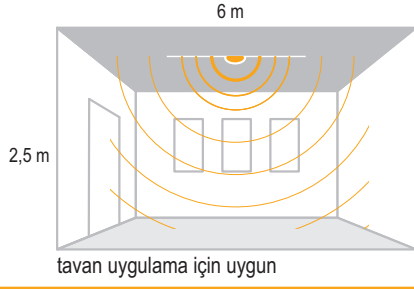

IP 20

kod no	özellikler	koli adedi	fiyat
5513 5110	360 Derece	50	7,85 \$

### 180° Hareket Sensörü

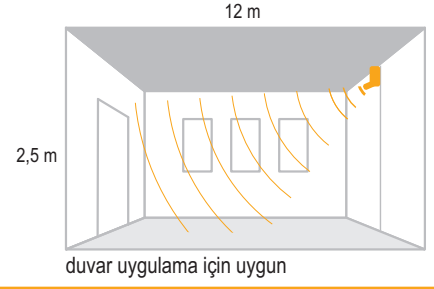

IP 20

kod no	özellikler	koli adedi	fiyat
5513 5010	180 Derece Hareket Sensörü	50	7,35 \$

### Mini Hareket Sensörü

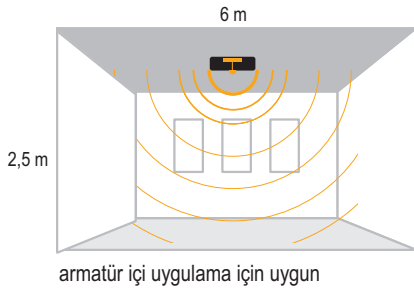

IP 20

kod no	özellikler	koli adedi	fiyat
5513 5340	Mini Hareket Sensörü	100	7,35 \$

### Radar Sensör

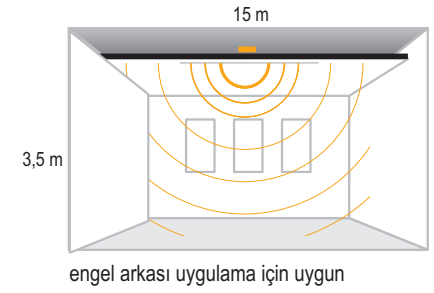

IP 20

kod no	özellikler	koli adedi	fiyat
5513 5220	Radar Sensör	100	12,25 \$

### Sıva Altı Tavan Sensör

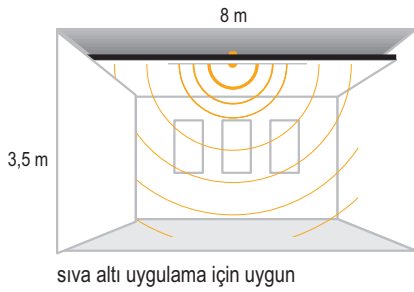

IP 20

kod no	özellikler	koli adedi	fiyat
5513 5230	Sıva Altı Tavan Sensör	50	8,90 \$

### Sıva Altı Tavan Sensör Küçük

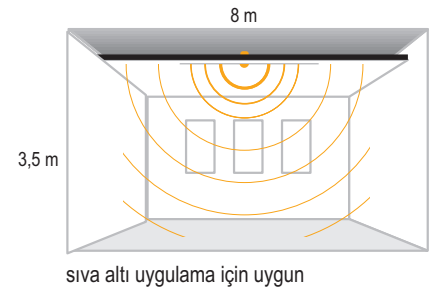

IP 20

kod no	özellikler	koli adedi	fiyat
5513 5330	Sıva Altı Tavan Sensör Küçük	100	8,90 \$

### Ip65 Sensör Kutusu



IP 20

kod no	özellikler	koli adedi	fiyat
5513 5390	Ip65 Sensör Kutusu	50	9,00 \$

### Fotosel

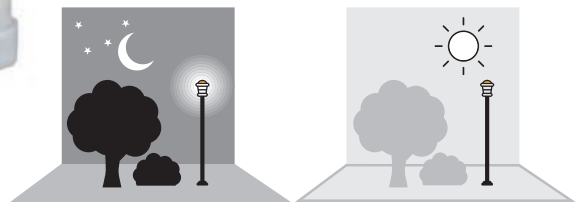

IP 20

kod no	özellikler	koli adedi	fiyat
5513 5550	Fotosel	100	4,70 \$

### Varlık Sensörü

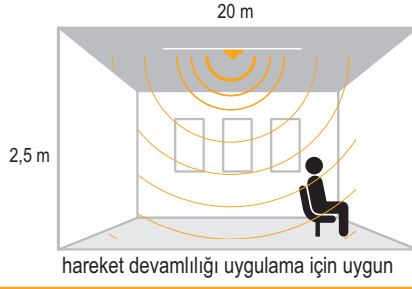

IP 20 ☺

kod no	özellikler	koli adedi	fiyat
5513 5350	Varlık Sensörü	50	20,00 \$

### Dört Yönlü Hareket Sensörü

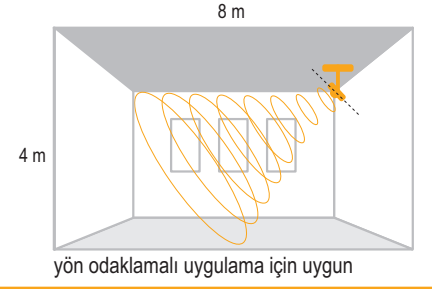

IP 20 ☺

kod no	özellikler	koli adedi	fiyat
5513 5310	Dört Yönlü Hareket Sensörü	100	12,00 \$

### İç Sensör

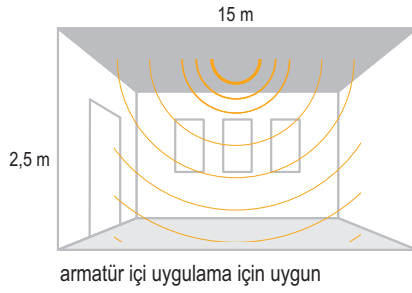

IP 20 ☺

kod no	özellikler	koli adedi	fiyat
5513 5210	İç Sensör	100	9,30 \$

### Yüksek Tavan Sensörü

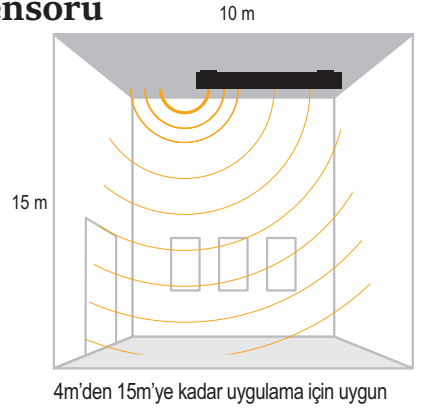

IP 20 ☺

kod no	özellikler	koli adedi	fiyat
5513 5320	Yüksek Tavan Sensörü	50	28,5 \$

### Duyulu Hareket Sensörü

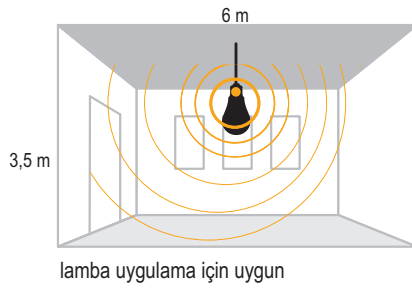

IP 20 ☺

kod no	özellikler	koli adedi	fiyat
5513 5150	Duyulu Hareket Sensörü	50	9,25 \$

### Anahtar Sensör

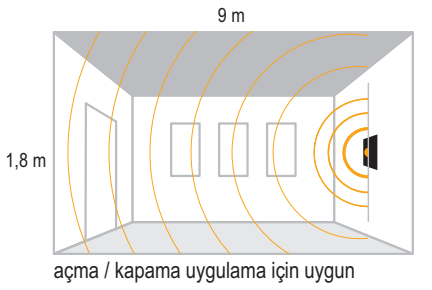

IP 20 ☺

kod no	özellikler	koli adedi	fiyat
5513 5170	Anahtar Sensör	50	8,90 \$

### İç Sensör + Led Driver (15W)

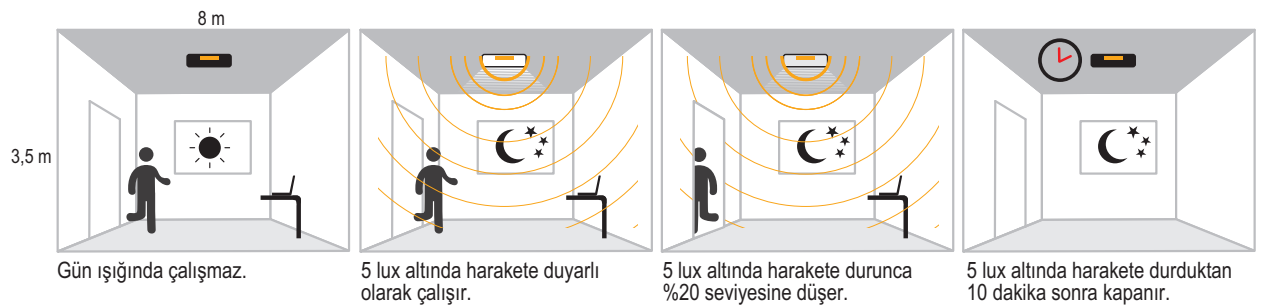

IP 20 ☺

kod no	özellikler	koli adedi	fiyat
5513 5420	Radar Sensörlü Dim Driver 27w (30-51V /DC 300 mA)	50	28,00 \$
5513 5410	Radar Sensörlü Dim Driver 15w (30-45V /DC 600 mA)	50	25,00 \$

# Pelsan Sensörlü Armatürler



## Işık Tam Zamanında Yansın!

- Time butonu ile lambanın ne kadar süreyle yanacağı,
- Sens butonu ile lambanın ne kadar mesafeden hareketi algılayıp yanacağı ayarlanabilir.
- (-) işareti yükün yalnızca gece (+) işareti gündüz ve gece açık olacağını belirtir.
- Max.montaj yüksekliği 4.5m'dir.

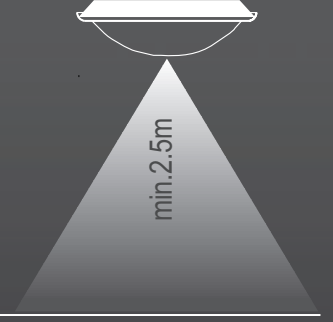

## Sense Sensörlü

IP240

kod no	özellikler	koli adedi	fiyat
5413 2011	2xE27 Sensörlü	8	11,70 \$

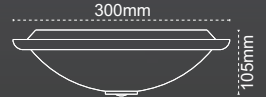

## Sense Acil Sensörlü

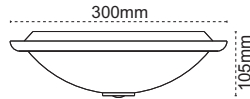

IP 20

kod no	özellikler	koli adedi	fiyat
5413 2113	2xE27 Sensörlü + Acil Ayd.	8	25,40 \$

## Senseled Sensörlü

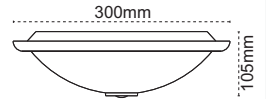

IP 20

kod no	özellikler	koli adedi	fiyat
5413 2014	6W LED Sensörlü	8	20,55 \$

## Senseled Acil Sensörlü

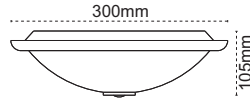

IP 20

kod no	özellikler	koli adedi	fiyat
5413 2114	8W LED Sensörlü + Acil Ayd.	8	28,30 \$

## IP66 Havana Radar Sensörlü

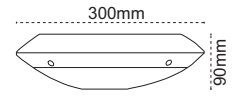

IP 66

kod no	özellikler	koli adedi	fiyat
5610 6630	15W LED Radar Sensörlü	8	47,10 \$

## Dekoled Radar Sensörlü



IP 40

kod no	özellikler	koli adedi	fiyat
5615 8655	12W LED 35X35 Radar Sens.	5	62,50 \$
5615 8653	12W LED 35X35 Radar Sens. + Acil Ayd.	5	118,90 \$

## Sense

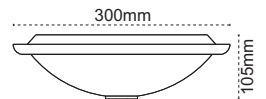

IP 20

kod no	özellikler	koli adedi	fiyat
5413 2010	2xE27	8	9,00 \$



## Işığa hareket kazandırır

### ► Multiline LED Lineer Armatür

Multiline lineer armatür, mağaza, market, ofis ve depolarda ışığın istenen yönde iletilmesini sağlayan hareketli sistemi, modern endüstriyel tasarımı ile yönlendirilebilir lineer aydınlatma sağlar.

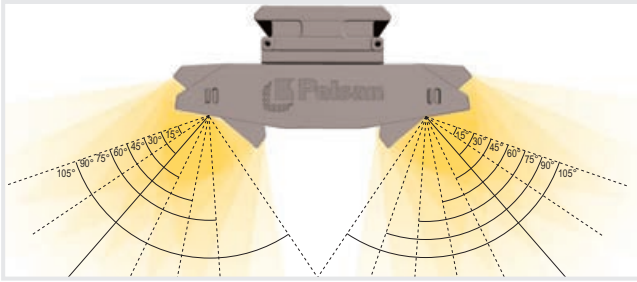
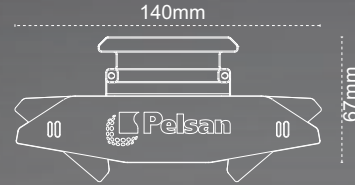

#### Işığı İsteddiğiniz Noktaya Yönlendirir

7 kademeli ayarlanabilir ışık açısı ile pratik bir şekilde istediğiniz yere ışığı yönlendirilebilir. (15° - 105°)



Pa menşei LED çip ve driver



lm/W verimlilik



Alüminyum gövde ile dayanıklı, estetik ve hafif



Üstü veya sarkıt uygulaması



Yağışma engelleyici özel diffüzörlü

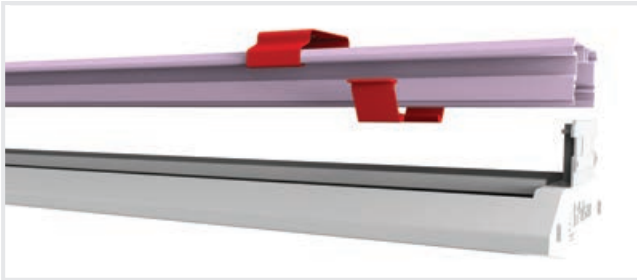

#### Kurulum Kolaylığı Sağlar

Multiline 2 parça halinde kolay ve güvenli şekilde monte edilir.

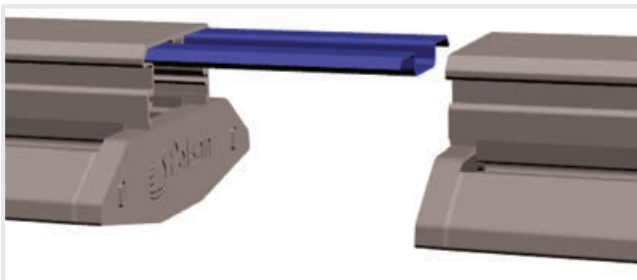

#### Sürekli Lineer Aydınlatma Olşturur

Lineer bağlantı için tasarlanmış yan kapaklar ve bağlantı aparatı ile kesintisiz ışık imkanı verir.

#### Opsiyonlar

- Acil aydınlatma kiti (1-3 saat)
- DALI 1-10V Dim
- 120cm / 150cm boy
- 3000K-4000K-6500K
- Buzlu ve şeffaf cam

## Multiline LED Lineer Armatür



IP 40

kod no	özellikler	koli adedi	fiyat
5612 6151	Multiline LED Lineer Arm. 35W 150cm	4	125,00 \$
5612 6161	Multiline LED Lineer Arm. 50W 150cm	4	145,00 \$



Aparatlar fiyata dahildir.  
Enerji kablosu, 15 cm esnek bağlantı aparatı, mini bağlantı aparatı  
zemin montajı için gerekli klipsler, bitiş kapağı

## Linear, sürekli, homojen ışık

- Alüminyum gövde
- Anahtarlı ve eklenebilir form
- Sürekli ve homojen ışık
- Bitiş kapağı sayesinde güvenli kurulum
- İç mekan ve endüstriyel alanlarda kullanıma uygun

### Linea LED



IP 40

kod no	özellikler	koli adedi	fiyat
5951 6260	Linea LED 4W 6500K 30cm	30	6,30 \$
5951 6270	Linea LED 8W 6500K 60cm	30	7,60 \$
5951 6280	Linea LED 16W 6500K 117.3 cm	30	16,20 \$

## Linea Large LED

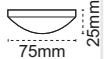

IP 40

kod no	özellikler	koli adedi	fiyat
5610 2130	Linea Large LED 18W 4000K 60cm	20	13,00 \$
5610 2110	Linea Large LED 18W 6500K 60cm	20	13,00 \$
5610 2140	Linea Large LED 36W 4000K 120cm	20	19,50 \$
5610 2120	Linea Large LED 36W 6500K 120cm	20	19,50 \$

## TMS LED Tube



IP 20

kod no	özellikler	koli adedi	fiyat	kod no	özellikler	koli adedi	fiyat
5012 9420	LED Tube TMS Tekli 60cm	12	5,10 \$	5012 9040	LED Tube TMS İkili 60cm	6	5,60 \$
5012 9430	LED Tube TMS Tekli 120cm	12	5,30 \$	5012 9530	LED Tube TMS İkili 120cm	6	6,80 \$
5012 9440	LED Tube TMS Tekli 150cm	12	8,50 \$	5012 9300	LED Tube TMS İkili 150cm	6	9,00 \$

## Etanj Duyulu Sac Bant LED Tube



IP 20

kod no	özellikler	koli adedi	fiyat	kod no	özellikler	koli adedi	fiyat
5024 1210	Etanj Duyulu Sac Bant Tekli 60cm	6	8,25 \$	5024 1230	Etanj Duyulu Sac Bant İkili 60cm	6	10,40 \$
5024 1220	Etanj Duyulu Sac Bant Tekli 120cm	6	9,80 \$	5024 1240	Etanj Duyulu Sac Bant İkili 120cm	6	11,40 \$
5024 6150	Etanj Duyulu Sac Bant Tekli 150cm	6	11,8 \$	5024 6140	Etanj Duyulu Sac Bant İkili 150cm	6	12,40 \$

## Market Armatürü LED Tube

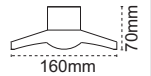

IP 20

kod no	özellikler	koli adedi	fiyat
5612 2511	T8 Market Arm. LED Tube 1x18W 120 cm	5	34,90 \$
5612 2521	T8 Market Arm. LED Tube 1x24W 150 cm	5	38,90 \$



## T8 TMS Floresan



IP 20

özellikler	koli adedi	Mek. Bal. kod no	fiyat	özellikler	koli adedi	Elek. Bal. kod no	fiyat
1x18W TMS T8 Floresan	6	5012 9031	29,70 ₺	1x18W TMS T8 Floresan	6	5012 9032	57,85 ₺
2x18W TMS T8 Floresan	6	5012 9041	31,15 ₺	2x18W TMS T8 Floresan	6	5012 9042	59,30 ₺
1x15W TMS T8 Floresan	6			1x15W TMS T8 Floresan	6	5012 9012	57,85 ₺
1x30W TMS T8 Floresan	6			1x30W TMS T8 Floresan	6	5012 9062	60,70 ₺
1x36W TMS T8 Floresan	6	5012 9081	32,90 ₺	1x36W TMS T8 Floresan	6	5012 9082	60,70 ₺
2x36W TMS T8 Floresan	6	5012 9091	50,80 ₺	2x36W TMS T8 Floresan	6	5012 9092	76,25 ₺
1x58W TMS T8 Floresan	6			1x58W TMS T8 Floresan	6	5012 9292	81,85 ₺
2x58W TMS T8 Floresan	6			2x58W TMS T8 Floresan	6	5012 9302	93,20 ₺

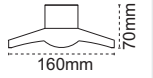

## T5 Market Armatürü



IP 20

özellikler	koli adedi	tekli kod no	fiyat	özellikler	koli adedi	çiftli kod no	fiyat
1x28W Elek. Bal. TL5	1	5612 2812	139,15 ₺	2x28W Elek. Bal. TL5	1	5612 2822	151,70 ₺
1x35W Elek. Bal. TL5	1	5612 2832	151,70 ₺	2x35W Elek. Bal. TL5	1	5612 2842	164,25 ₺
1x54W Elek. Bal. TL5	1	5612 2852	139,15 ₺	2x54W Elek. Bal. TL5	1	5612 2862	151,70 ₺
1x80W Elek. Bal. TL5	1	5612 2872	202,95 ₺	2x80W Elek. Bal. TL5	1	5612 2882	215,50 ₺

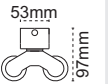

## T8 Etanj Duylu Sac Bant



IP 20

özellikler	koli adedi	mek. bal. kod no	fiyat	özellikler	koli adedi	elek. bal. kod no	fiyat
1x18W T8 Etanj Duylu Sac Bant	8	5024 1211	45,20 ₺	1x18W T8 Etanj Duylu Sac Bant	8	5024 1212	73,40 ₺
2x18W T8 Etanj Duylu Sac Bant	6	5024 1231	46,55 ₺	2x18W T8 Etanj Duylu Sac Bant	6	5024 1232	80,10 ₺
1x36W T8 Etanj Duylu Sac Bant	6	5024 1221	48,10 ₺	1x36W T8 Etanj Duylu Sac Bant	6	5024 1222	76,25 ₺
2x36W T8 Etanj Duylu Sac Bant	6	5024 1241	76,25 ₺	2x36W T8 Etanj Duylu Sac Bant	6	5024 1242	101,10 ₺
1x58W T8 Etanj Duylu Sac Bant	8			1x58W T8 Etanj Duylu Sac Bant	8	5024 6152	97,25 ₺
2x58W T8 Etanj Duylu Sac Bant	8			2x58W T8 Etanj Duylu Sac Bant	8	5024 6142	110,00 ₺



## T8 Etanj Duylu Polyester Bant



IP 65

özellikler	koli adedi	mek. bal. kod no	fiyat	özellikler	koli adedi	elek. bal. kod no	fiyat
1x36W T8 Polyester Bant	6	5024 1021	58,50 ₺	1x36W T8 Polyester Bant	6	5024 1022	86,40 ₺
2x36W T8 Polyester Bant	6	5024 1031	86,40 ₺	2x36W T8 Polyester Bant	6	5024 1032	111,60 ₺
1x58W T8 Polyester Bant	6			1x58W T8 Polyester Bant	6	5024 6042	125,20 ₺
2x58W T8 Polyester Bant	6			2x58W T8 Polyester Bant	6	5024 6052	146,50 ₺

## Yedek Parçalar

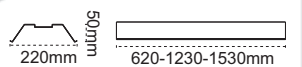
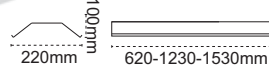

kod no	özellikler	koli adedi	fiyat	kod no	özellikler	koli adedi	fiyat	kod no	özellikler	koli adedi	fiyat
4201 815	Standart TMS 18W Ref.	10	17,05 ₺	4201 806	Geçmeli Bant 18W Ref.	10	19,60 ₺	4201 810	Etanj Duylu Sac Bant 18W Ref.	10	17,05 ₺
4201 816	Standart TMS 36W Ref.	10	19,75 ₺	4201 807	Geçmeli Bant 36W Ref.	10	26,95 ₺	4201 811	Etanj Duylu Sac Bant 36W Ref.	10	19,90 ₺
4201 817	Standart TMS 58W Ref.	10	25,75 ₺	4201 808	Geçmeli Bant 58W Ref.	10	32,45 ₺	4201 812	Etanj Duylu Sac Bant 58W Ref.	10	25,50 ₺
								4201 821	Etanj Duylu Poly. Bant 36W Ref.	10	26,85 ₺
								4201 822	Etanj Duylu Poly. Bant 58W Ref.	10	33,85 ₺

**Opsiyonlar**

- Dim (Dali 1-10V)
- Acil aydınlatma kiti
- Harici sensör
- Koridor fonksiyonu

Elektronik balastlı armatürlere göre %55 enerji tasarrufu

- Floresana göre 2 kat daha uzun ömür
- Toz ve su almaz, IP65
- Kaliteli komponentler ile ömrü boyunca yüksek verimli ışık çıkışı 3000K / 4000K / 6500K

**Largo LED**



kod no	özellikler	koli adedi	fiyat
5615 3511	Largo LED 36W 120 cm	6	37,00 \$
5615 3561	Largo LED 20W 60cm	6	28,00 \$
5615 3521	Largo LED 20W 120cm	6	30,00 \$
5615 3514	Largo LED 36W 120 cm acil ayd. kit	6	123,50 \$

**Largo LED Lux**



IP 65

kod no	özellikler	koli adedi	fiyat
5615 6361	Largo LED lux 21W 60cm	6	49,00 \$
5615 6371	Largo LED lux 42W 120 cm	6	57,00 \$
5615 6387	Largo LED lux 63W 150cm	6	95,00 \$

**Largo LED Frozen**



• Soğuk hava depoları ve donuk ürün depoları kullanımı için uygundur.

kod no	özellikler	koli adedi	fiyat
5615 6364	Largo LED Frozen 21W 60cm (-25° C)	6	119,00 \$
5615 6374	Largo LED Frozen 42W 120cm (-40° C)	6	229,00 \$
5615 6389	Largo LED Frozen 63W 150cm (-40° C)	6	339,00 \$

**Largo LED Radar Sensörlü**



IP 65

kod no	özellikler	koli adedi	fiyat
5615 3531	Largo LED 36W 120cm Radar Sensörlü	6	55,00 \$

**Largo LED Radar Sensörlü ve Acil Aydınlatma Kitli**



IP 65

kod no	özellikler	koli adedi	fiyat
5615 3534	Largo LED 36W 120cm Radar Sensörlü ve Kitli	6	141,50 \$

**Largo LED Tube Tekli Şeffaf Cam**



IP 65

• Acil aydınlatma kiti uygulanabilir (9-18W)

kod no	özellikler	koli adedi	fiyat
5021 8220	Largo LED Tube Tekli 60cm	6	12,30 \$
5021 8260	Largo LED Tube Tekli 120cm	6	15,90 \$
5021 8450	Largo LED Tube Tekli 150cm	6	22,50 \$
5913 1460	9-18W LED tube konv. kit	100	52,60 \$

**Largo LED Tube İkili Şeffaf Cam**



IP 65

• Acil aydınlatma kiti uygulanabilir (9-18W)

kod no	özellikler	koli adedi	fiyat
5021 8240	Largo LED Tube İkili 60cm	6	13,60 \$
5021 8280	Largo LED Tube İkili 120cm	6	17,90 \$
5021 8460	Largo LED Tube İkili 150cm	6	25,90 \$
5913 1460	9-18W LED tube konv. kit	100	52,60 \$

## 1,5 yıl geri ödeme süresi

- 100 lm/W'ı aşan verimlilik
- Avrupa LED çip
- Avrupa LED driver
- Alüminyum gövde
- Su ve toz almaz IP65
- Kamaşma kontrollü opal difüzör



## Solida

### IP 65 LED Etanj

IP65

kod no	özellikler	koli adedi	fiyat
5614 2113	Solida 23W 60cm	6	66,00 \$
5614 2133	Solida 35W 90cm	6	85,00 \$
5614 2153	Solida 45W 120cm	6	113,00 \$
5614 2163	Solida 65W 120cm	6	150,00 \$

### Opsiyonlar

- Dali driver
- Acil aydınlatma kiti
- Harici sensör uygulaması

## Inovaled

### IP 65 LED Etanj

- Alüminyum Gövde



IP 65

kod no	özellikler	koli adedi	fiyat
5614 1671	Inovaled 21W 60 cm	6	68,00 \$
5614 1531	Inovaled 42W 120 cm	6	102,00 \$
5614 1501	Inovaled 63W 150 cm	6	132,50 \$

## Prota

### IP 65 LED Etanj

- Alüminyum Gövde



IP 65

kod no	özellikler	koli adedi	fiyat
5614 2213	Prota 23W 60cm	6	56,50 \$
5614 2233	Prota 35W 90cm	6	75,50 \$
5614 2253	Prota 45W 120cm	6	103,50 \$
5614 2263	Prota 65W 120cm	6	141,50 \$

## Largo T8

### IP65 Etanj

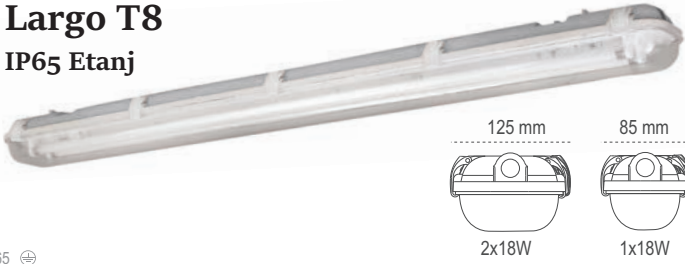

IP 65

kod no	özellikler	koli adedi	fiyat
5021 8222	Largo 1x18W Elek. Bal. TLD	6	77,90 ₺
5021 8242	Largo 2x18W Elek. Bal. TLD	6	81,90 ₺
5021 8262	Largo 1x36W Elek. Bal. TLD	6	93,70 ₺
5021 8282	Largo 2x36W Elek. Bal. TLD	6	103,30 ₺
5021 8452	Largo 1x58W Elek. Bal. TLD	6	122,10 ₺
5021 8462	Largo 2x58W Elek. Bal. TLD	6	141,80 ₺

## Solta T8

### IP65 Etanj



IP 65

- PC Gövde PC Camlı

kod no	özellikler	koli adedi	fiyat
5021 9562	Solta 1X18W Elek. Bal. TLD	6	101,90 ₺
5021 9572	Solta 2X18W Elek. Bal. TLD	6	102,50 ₺
5021 9582	Solta 1X36W Elek. Bal. TLD	6	120,50 ₺
5021 9592	Solta 2X36W Elek. Bal. TLD	6	142,00 ₺

## Mar Etanj



IP 65

kod no	özellikler	koli adedi	fiyat
5021 1532	Mar 3x18 Elek. Bal. TLD	4	136,60 ₺
5021 1542	Mar 4x18 Elek. Bal. TLD	4	141,00 ₺
5021 1552	Mar 3x36 Elek. Bal. TLD	4	204,40 ₺
5021 1562	Mar 4x36 Elek. Bal. TLD	4	208,70 ₺
5021 1572	Mar 3x58 Elek. Bal. TLD	4	279,10 ₺
5021 1582	Mar 4x58 Elek. Bal. TLD	4	281,80 ₺

## Emergency

### IP65 30 LED'li AC/DC



IP 65

kod no	özellikler	koli adedi	fiyat
5514 1060	30 LED'li 5W 35cm	12	38,80 \$

# Pelsan ACil Aydınlatma Armatürleri

## 2x10W LED'li 6 Saat

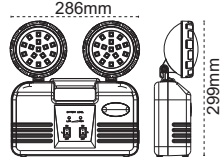

IP 40

kod no	özellikler	koli adedi	fiyat
5514 1130	2x10W LED'li 6 Saat	8	103,70 \$

## 2x5W LED'li 4 Saat

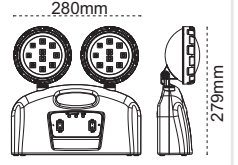

IP 40

kod no	özellikler	koli adedi	fiyat
5514 1120	2x5W LED'li 4 Saat	8	37,70 \$

## 2x20W DC 3 Saat

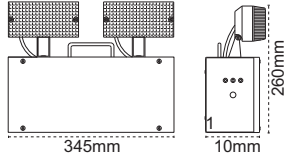

IP 40

kod no	özellikler	koli adedi	fiyat
5514 1010	2x20W DC 3 Saat	12	105,00 \$

## 2x50W DC 1 Saat

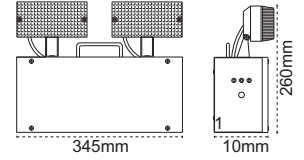

IP 40

kod no	özellikler	koli adedi	fiyat
5514 1030	2x50W DC 1 Saat	12	111,20 \$

## 2x3W LED'li 5 Saat

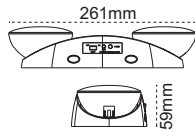

IP 40

kod no	özellikler	koli adedi	fiyat
5514 1110	2x3W LED'li 5 Saat	10	29,00 \$

## IP65 30 LED'li AC/DC Emergency

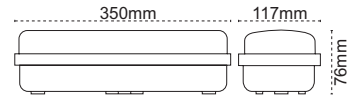

IP 65

kod no	özellikler	koli adedi	fiyat
5514 1060	5W 30 LED'li	12	38,80 \$

## 72 LED'li Işıldak

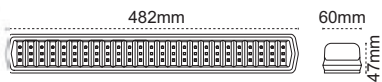

IP 40

kod no	özellikler	koli adedi	fiyat
5061 1240	72 LED'li Işıldak	24	14,60 \$

## 24 LED'li AC/DC Emergency

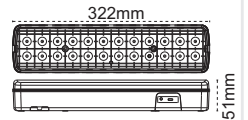

IP 40

kod no	özellikler	koli adedi	fiyat
5514 1140	24 LED'li AC/DC	20	15,50 \$

## 18 LED'li El Feneri

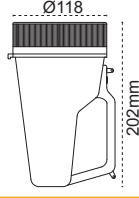

IP 20

kod no	özellikler	koli adedi	fiyat
5061 1180	18 LED'li El Feneri	30	6,60 \$

## 16 LED'li El Feneri

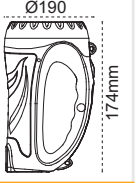

IP 20

kod no	özellikler	koli adedi	fiyat
5061 1110	16 LED'li El Feneri	30	11,80 \$

## 24 LED'li Kamp Feneri Kırmızı

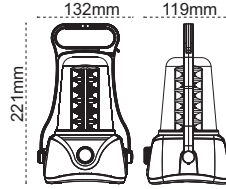

IP 20

kod no	özellikler	koli adedi	fiyat
5061 1330	24 LED'li Kamp Feneri Kırmızı	10	12,70 \$

## 24 LED'li Kamp Feneri Beyaz

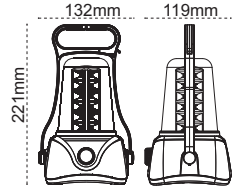

IP 20

kod no	özellikler	koli adedi	fiyat
5061 1390	24 LED'li Kamp Feneri Beyaz	10	12,70 \$

## 24+6 LED'li Işıldak

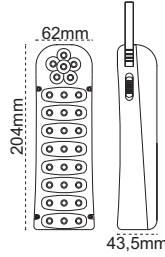

IP 20

kod no	özellikler	koli adedi	fiyat
5061 1170	24+6 LED'li Işıldak	60	7,60 \$

## 18+5 LED'li Işıldak

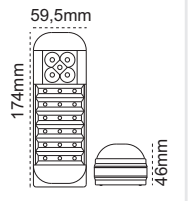

IP 20

kod no	özellikler	koli adedi	fiyat
5061 1070	18+5 LED'li Işıldak	80	6,70 \$

## 9 LED'li El Feneri

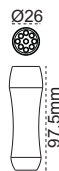

IP 20

kod no	özellikler	koli adedi	fiyat
5061 1200	9 LED'li El Fener Gümüş	128	2,55 \$
5061 1210	9 LED'li El Fener Bordo	128	2,55 \$
5061 1220	9 LED'li El Fener Krom	128	2,55 \$
5601 1230	9 LED'li El Fener Siyah	128	2,55 \$

## 4+1 LED'li Çakılı El Feneri



IP 20

kod no	özellikler	koli adedi	fiyat
5061 1310	4+1 LED'li Çakılı El Feneri	50	4,50 \$



**200  
Çeşit  
Etiket  
Opsiyonlu!**



**S.A Exiled Exit  
Etiket Opsiyonlu**

kod no	özellikler	koli adedi	fiyat
5513 1741	S.A Tek Yön Opsiyonlu Exiled	10	16,90 \$
5513 1751	S.A Çift Yön Opsiyonlu Exiled	10	21,70 \$

- Ürün Kodu ile birlikte etiket seçiminizi bildiriniz.
- 200 çeşit etiket opsiyonu 5513 1741, 5513 1751, 5513 1522, 5513 1512 kodları için geçerlidir.

**Exiled Exit  
Etiket Opsiyonlu**

kod no	özellikler	koli adedi	fiyat
5513 1522	Tek Yön Opsiyonu Exiled	10	12,25 \$
5513 1512	Çift Yön Opsiyonlu Exiled	10	17,00 \$



farklı seçenekler için  
[www.pelsan.com.tr](http://www.pelsan.com.tr)

**Exiled Exit  
Tek Yön**

sabit etiketli

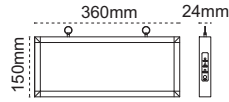

kod no	özellikler	koli adedi	fiyat
5513 1521	Tek Yön 3W 3 Saat	10	7,50 \$

**Exiled Exit  
Çift Yön**

sabit etiketli

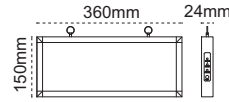

kod no	özellikler	koli adedi	fiyat
5513 1511	Çift Yön 3W 3 Saat	10	7,50 \$

**Exiled Exit  
Çift Yön**

sabit etiketli

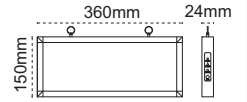

kod no	özellikler	koli adedi	fiyat
5513 1410	Çift Yön 3W 3 Saat	10	7,50 \$

**Exiled Exit  
Çift Yön**

sabit etiketli

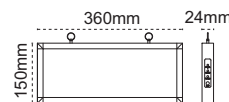

kod no	özellikler	koli adedi	fiyat
5513 1430	Çift Yön 3W 3 Saat	10	7,50 \$

**Exiled Exit  
Çift Yön**

sabit etiketli

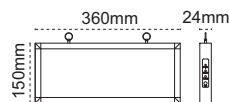

kod no	özellikler	koli adedi	fiyat
5513 1440	Çift Yön 3W 3 Saat	10	7,50 \$

**Exiled Exit  
Çift Yön**

sabit etiketli

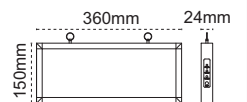

kod no	özellikler	koli adedi	fiyat
5513 1420	Çift Yön 3W 3 Saat	10	7,50 \$



## Vialed Sarkıt

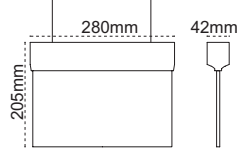

IP 20

kod no	özellikler	koli adedi	fiyat
5513 4210	Tek Yön Sarkıt 3W	1	30,10 \$
5513 4220	Çift Yön Sarkıt 3W	1	33,30 \$

## S.Ü.Vialed

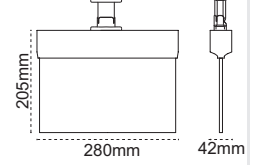

IP 20

kod no	özellikler	koli adedi	fiyat
5513 4010	Mafsallı Tek Yön Exit 3W	1	30,10 \$
5513 4020	Mafsallı Çift Yön Exit 3W	1	33,10 \$

## S.A Vialed

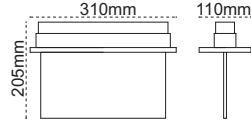

IP 20

kod no	özellikler	koli adedi	fiyat
5513 4110	S.A Tek Yön 3W	1	37,70 \$
5513 4120	S.A Çift Yön 3W	1	41,00 \$

## S.Ü.Vialed 55 CM

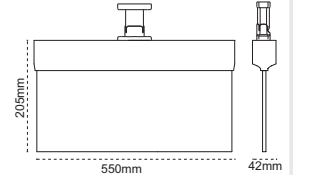

IP 20

kod no	özellikler	koli adedi	fiyat
5513 4030	Mafsallı Tek Yön Exit	1	62,10 \$
5513 4040	Mafsallı Çift Yön Exit	1	65,90 \$
5513 4230	Sarkıt Tek Yön Exit	1	62,10 \$
5513 4240	Sarkıt Çift Yön Exit	1	65,90 \$

## Profil Zincir

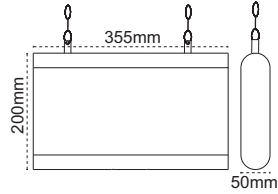

IP 20

kod no	özellikler	koli adedi	fiyat
5513 2471	Profil Zincir Tek Yön 3 SAAT	1	51,40 \$
5513 2441	Profil Zincir çift Yön 3 SAAT	1	54,60 \$

## Profil Tavan

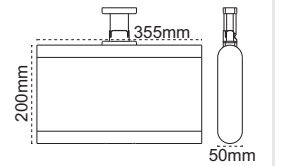

IP 20

kod no	özellikler	koli adedi	fiyat
5513 3341	Profil Tavan Tek Yön 3 SAAT	1	51,40 \$
5513 3381	Profil Tavan çift Yön 3 SAAT	1	54,60 \$

## Profil Duvar

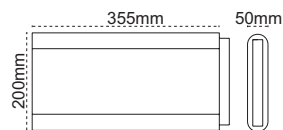

IP 20

kod no	özellikler	koli adedi	fiyat
5513 2261	Profil Duvar Tek Yön 3 SAAT	1	51,40 \$
5513 2281	Profil Duvar çift Yön 3 SAAT	1	54,60 \$

## Profil 220v

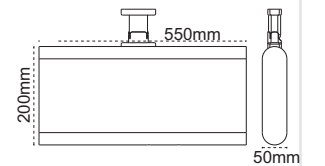

IP 20

kod no	özellikler	koli adedi	fiyat
5513 1721	Profil 220V	1	47,30 \$

## Clear

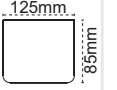

IP 40

kod no	özellikler	koli adedi	fiyat
5615 3211	Clear LED 36W 120 CM	1	41,50 \$
5017 9002	T1 Clear 1X18W T8 Arm. Elek. Bal.	1	81,70 ₺
5017 9012	T1 Clear 2X18W T8 Arm. Elek. Bal.	1	98,90 ₺
5017 9022	T1 Clear 1X36W T8 Arm. Elek. Bal.	1	102,00 ₺
5017 9032	T1 Clear 2X36W T8 Arm. Elek. Bal.	1	122,60 ₺

## Şeffaf-Opal

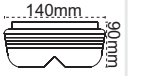

IP 40

kod no	özellikler	koli adedi	fiyat
5017 2012	T1 Şeffaf 1X18W T8 Elek. Bal.	1	85,40 ₺
5017 2022	T1 Şeffaf 2X18W T8 Elek. Bal.	1	103,30 ₺
5017 2112	T1 Şeffaf 1X36W T8 Elek. Bal.	1	106,70 ₺
5017 1542	T1 Şeffaf 2X36W T8 Elek. Bal.	1	131,00 ₺
5016 2012	T1 Opal 1X18W T8 Elek. Bal.	1	85,40 ₺
5016 2022	T1 Opal 2X18W T8 Elek. Bal.	1	103,20 ₺
5016 2112	T1 Opal 1X36W T8 Elek. Bal.	1	106,70 ₺
5016 1542	T1 Opal 2X36W T8 Elek. Bal.	1	131,00 ₺

## Plex



IP 40

kod no	özellikler	koli adedi	fiyat
5019 5212	Opal 2x18W Elek. Bal. TLD	1	101,80 ₺
5019 5222	Opal 2x36W Elek. Bal. TLD	1	126,10 ₺
5019 5272	Prizmatik Lensli 2x18W Elek. Bal. TLD	1	101,80 ₺
5019 5282	Prizmatik Lensli 2x36W Elek. Bal. TLD	1	126,10 ₺

## Linea Large LED

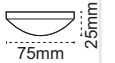

IP 40

- Alüminyum gövde
- Homojen ışık
- İç mekan ve endüstriyel alanlarda kullanıma uygun

kod no	özellikler	koli adedi	fiyat
5610 2110	Linea Large LED 18W 6500K 60cm	20	13,00 \$
5610 2120	Linea Large LED 36W 6500K 120cm	20	19,50 \$
5610 2130	Linea Large LED 18W 4000K 60cm	20	13,00 \$
5610 2140	Linea Large LED 36W 4000K 120cm	20	19,50 \$

## Linea LED



IP 40

- Alüminyum gövde
- Anahtarlı ve eklenebilir form
- Sürekli ve homojen ışık
- Bitiş kapağı sayesinde güvenli kurulum
- İç mekan ve endüstriyel alanlarda kullanıma uygun

Aparatlar fiyata dahildir.  
Enerji kablosu, 15 cm esnek bağlantı aparatı, mini bağlantı aparatı  
zemin montajı için gerekli klipsler, bitiş kapağı

kod no	özellikler	koli adedi	fiyat
5951 6260	Linea LED 4W 6500K 30cm	30	6,30 \$
5951 6270	Linea LED 8W 6500K 60cm	30	7,60 \$
5951 6280	Linea LED 16W 6500K 117,3	30	16,20 \$

# Atölye Armatürleri Pelsan

Modern yapısı ile atölye gibi endüstriyel ortamlarda, ofis- mağaza -marketler gibi tasarımın önemli olduğu mekanlarda kullanıma uygundur.



## Volga

- E27 Duyulu
- 30W ve 40W Pelsan LED lambalar ile kullanıma uygun

## Volga LED

- 50W
- 50.000 saat uzun ömür
- Renksel geriverim >80

## Volga



IP40

kod no	özellikler	koli adedi	fiyat
5616 4741	Volga 50W LED Silver Atölye Arm.	6	75,40 \$
5616 4751	Volga 50W LED White Atölye Arm.	6	75,40 \$
5212 4011	Volga E27 Silver Atölye Arm.	6	37,80 \$
5212 4021	Volga E27 White Atölye Arm.	6	37,80 \$

## Gediz



Øxaxbmm  
160W/420x260x175  
250W/420x310x175  
500W/500x322x143

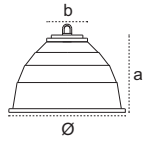

IP 40

kod no	özellikler	koli adedi	fiyat
5212 1010	Gediz 160W E27 Alm. Atölye Arm Boş.	10	66,30 ₺
4080 701	Q402mm Cam+Conta+Klips	10	39,00 ₺
4101 521	Q420mm Tel Kafes	1	28,40 ₺
5212 1090	Gediz Boş E40	1	87,00 ₺
4080 702	Q482mm Cam+Conta+Klips	1	47,00 ₺
4101 522	Q500mm Tel Kafes	1	37,40 ₺

## Ceyhan PC IP65/IP20

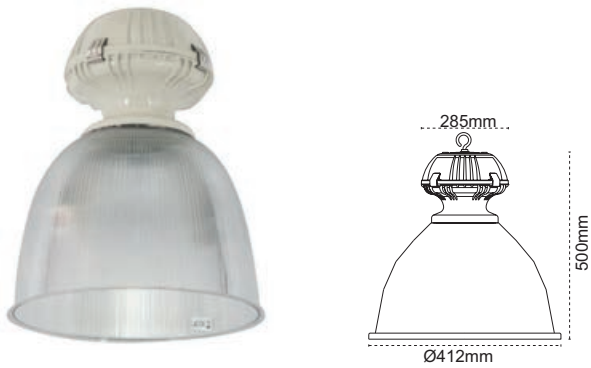

IP 65/20

kod no	özellikler	koli adedi	fiyat
5213 3310	Ceyhan Atölye Arm. Boş E27	4	156,30 ₺
5213 3320	Ceyhan Atölye Arm. Boş E40	4	153,80 ₺
5213 3331	Ceyhan 250W PC MH/SB Atölye Arm.	4	234,20 ₺

## Fırat

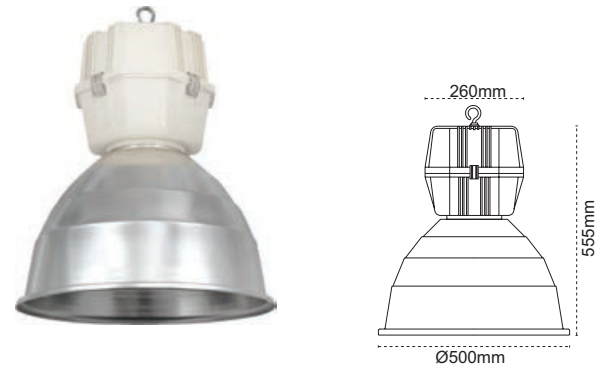

IP 65/20

kod no	özellikler	koli adedi	fiyat
5212 1121	Fırat 250W E40 MH/SB Poly. Atölye Arm.	4	220,60 ₺
5212 1191	FIRAT 400W E40 MH Poly. Atölye Arm.	4	243,80 ₺
5212 1201	FIRAT 400W E40 SB Poly. Atölye Arm.	4	268,00 ₺
4080 702	Atölye Camı (482X4mm) + Conta ve Mandal	1	47,00 ₺
4101 522	400W Atölye Tel Kafes	1	36,40 ₺

## Karpat LED Performans

### IP65 Yüksek Tavan Armatürü

130 lm/W verimlilik

- Temperli ve filmli cam
- Yüksek ve alçak tavan uygulamaları için uyumlu

#### Opsiyonlar

- Acil aydınlatma kiti
- Harici sensör uygulaması
- Dim edilebilme
- Busbar askı takımı
- Koridor fonksiyonu



axbxcmm  
40W :1210x90x73  
75W :1210x168x73  
110W:1210x325x73  
150W:1210x325x73

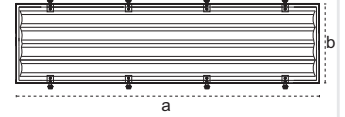
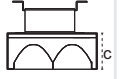

IP 65

kod no	özellikler	koli adedi	fiyat
5615 6461	Karpat LED Performans 40W 4000/6500K	1	122,50 \$
5615 6471	Karpat LED Performans 75W 4000/6500K	1	160,50 \$
5615 6481	Karpat LED Performans 110W 4000/6500K	1	245,50 \$
5615 6491	Karpat LED Performans 150W 4000/6500K	1	282,50 \$

## Karpat LED Standart

### IP65 Yüksek Tavan Armatürü

110 lm/W verimlilik

- Temperli ve filmli cam
- Yüksek ve alçak tavan uygulamaları için uyumlu

#### Opsiyonlar

- Acil aydınlatma kiti
- Harici sensör uygulaması
- Dim edilebilme
- Busbar askı takımı
- Koridor fonksiyonu



axbxcmm  
42W :1210x90x73  
82W :1210x168x73  
120W:1210x325x73  
164W:1210x325x73

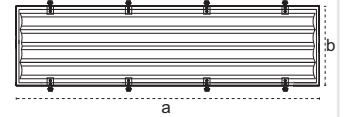
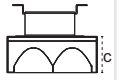

IP 65

kod no	özellikler	koli adedi	fiyat
5615 6261	Karpat LED Standart 42W 4000/6500K	1	103,00 \$
5615 6241	Karpat LED Standart 82W 4000/6500K	1	141,00 \$
5615 6281	Karpat LED Standart 120W 4000/6500K	1	192,00 \$
5615 6251	Karpat LED Standart 164W 4000/6500K	1	236,00 \$

## Karpat LED Frozen

### IP65 Yüksek Tavan Armatürü

-40°C dereceye kadar düşük sıcaklıkta yüksek verimle çalışma

- Soğuk hava depoları ve donuk ürün depoları için uygun
- Temperli ve filmli cam

#### Opsiyonlar

- Acil aydınlatma kiti
- Harici sensör uygulaması
- Dim edilebilme
- Busbar askı takımı
- Koridor fonksiyonu



axbxcmm  
42W :1210x90x73  
82W :1210x168x73  
164W:1210x325x73

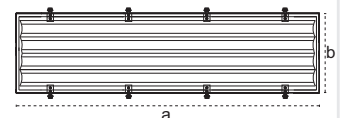
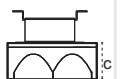

IP 65

kod no	özellikler	koli adedi	fiyat
5615 6262	Karpat LED Frozen 42W 4000/6500K	1	240,00 \$
5615 6242	Karpat LED Frozen 82W 4000/6500K	1	465,00 \$
5615 6252	Karpat LED Frozen 164W 4000/6500K	1	620,00 \$

## Karpat T5

### IP65 Yüksek Tavan Armatürü

HID lambalara göre daha yüksek enerji tasarrufu

- Temperli ve filmli cam
- Yüksek ve alçak tavan uygulamaları için uyumlu

#### Opsiyonlar

- Acil aydınlatma kiti
- Harici sensör uygulaması
- Dim edilebilme
- Busbar askı takımı



axbxcmm  
2x54W:1210x190x82  
4x54W:1210x345x82  
2x80W:1510x190x82  
4x80W:1510x345x82

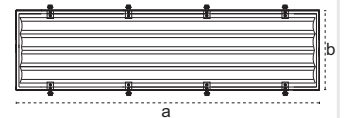
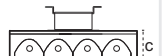

IP 65

kod no	özellikler	koli adedi	fiyat
5014 2972	Karpat 2X54W T5	1	80,00 \$
5014 4882	Karpat 4X54W T5	1	145,00 \$
5014 2992	Karpat 2X80W T5	1	100,00 \$
5014 4962	Karpat 4X80W T5	1	175,00 \$

## Sia

### IP65 LED Yüksek Tavan Armatürü

#### Opsiyonlar

- Dar, geniş, asimetrik lens seçenekleri
- Dali dim
- Siyah, beyaz, gri renk opsiyonu



- Power LED 100.000 saati aşan ömür
- Alüminyum enjeksiyon gövde
- 125 lümen /W 'a varan verimlilik
- 1-10V dim standart 2-Step dim standart
- 15-25 metre yüksek tavan uygulaması
- Temperli cam ile güvenli

axbxcmm
75W 342x342x123
100W 342x342x123
125W 342x342x123

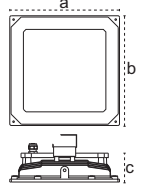

IP 65 ☺

kod no	özellikler	koli adedi	fiyat
5616 4421	Sia 75W 4000/6500K	1	255,00 \$
5616 4431	Sia 100W 4000/6500K	1	295,00 \$
5616 4441	Sia 125W 4000/6500K	1	340,00 \$

## Castor

### IP65 LED Yüksek Tavan Armatürü



- Alüminyum enjeksiyon gövde
- Hafif gövdesi ile kolay montaj ve kurulum
- >90 lm/W
- 3 farklı boy seçeneği
- PC hammaddeli, kamaşma yapmayan optik difüzör
- 30cm zincir aparatı ile sarkıtılabilir

axbxcmm
100W 295x295x90
150W 345x345x95
200W 395x395x105



IP 40 ☺

kod no	özellikler	koli adedi	fiyat
5616 2810	Castor 100W 5000K	1	95,00 \$
5616 2820	Castor 150W 5000K	1	150,00 \$
5616 2830	Castor 200W 5000K	1	199,00 \$

## Logan

### IP44 Yüksek Tavan Armatürü



- Gıda tesisleri için uygun çözüm
- PC Cam lambalara %60
- HID göre daha yüksek enerji tasarrufu
- Basbar askı takımı opsiyonu

axbxcmm
2x54W:1210x190x82
4x54W:1510x190x82
2x80W:1210x190x82
4x80W:1510x190x82

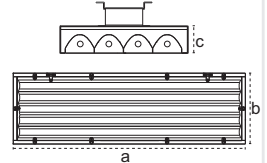

IP 44 ☺

kod no	özellikler	koli adedi	fiyat
5055 7272	Logan 2X54W T5	1	70,50 \$
5055 7262	Logan 2X80W T5	1	85,25 \$
5055 7322	Logan 4X54W T5	1	87,00 \$
5055 7312	Logan 4X80W T5	1	136,00 \$

## Oriza

### IP65 Yüksek Tavan Armatürü

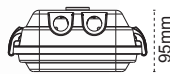

IP 65 ☺ • Basbar askı takımı opsiyonu

kod no	özellikler	koli adedi	fiyat
5615 3311	Oriza 2X54W T5 Elek. Bal. 1285x180x95	1	73,00 \$
5055 7352	Oriza 2X80W T5 Elek. Bal. 1595x180x95	1	89,00 \$
5055 7362	Oriza LED 82W 4000/6500K 1285x180x95	1	103,00 \$

## Busbar Askı Takımı

Karpat ve Oriza yüksek tavan armatürlerinin her varyasyonu için uygundur.



axbmm
Busbar: 35x55
Busbar: 23x45
Busbar: 28x62

kod no	özellikler	koli adedi	fiyat
4001 449	Busbar Askı Takımı 35x55	1	4,50 \$
4001 468	Busbar Askı Takımı 23x45	1	4,50 \$
4001 469	Busbar Askı Takımı 28x62	1	4,50 \$



**Yüksek performanslı  
Pelsan benzinlik armatürleri**

- Hafif gövdesi ile kolay montaj ve kurulum
- İnce alüminyum yapısı ile dayanıklı ve modern görünüm
- Yüksek verimli komponentleri ile ömrü boyunca yüksek ışık çıkışı
- Enerji tasarrufu ve bakım gerektirmeyen yapısı ile ekonomik çözüm
- Temperli cam ile güvenlik sağlar

**Piroliz**

**IP65 LED Kanopi Armatür**



- 125 lümen /W 'a varan verimlilik
- Alüminyum gövde
- Temperli cam

**Opsiyonlar**

- 1-10V dim
- 2-Step dim
- Farklı açılarda lens uygulama

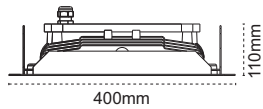

**Okta**

**IP65 LED Kanopi Armatür**



- 100 lümen /W 'a varan verimlilik
- Alüminyum gövde
- Temperli cam

**Opsiyonlar**

- Dar, geniş, asimetric lens seçenekleri
- Dali, 1-10V dim opsiyonu
- Siyah, beyaz ve gri renk opsiyonu

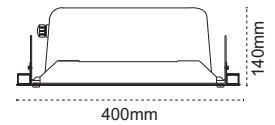

IP 65

kod no	özellikler	koli adedi	fiyat
5616 4061	Piroliz 75W 4000 / 6500K	1	255,00 \$
5616 4071	Piroliz 100W 4000 / 6500K	1	295,00 \$
5616 4081	Piroliz 125W 4000 / 6500K	1	340,00 \$

IP 65

kod no	özellikler	koli adedi	fiyat
5616 4341	Okta LED 80W 4000 / 6500K	1	199,00 \$

## ATEX Belgeli

- **Gaz Patlama Koruması: Zone 2**  
II 3G Ex nR IIC T5 Gc
- **Toz Patlama Koruması: Zone 22**  
II 3D Ex tc IIIC (T95 C) Dc
- **Standartlar**  
EN 60079-0: 2012, EN 60079-15: 2010,  
EN 60079-31:2009
- **Sertifika Numarası**  
IEP 16 ATEX 0468
- **Zone Sınıfı**  
Zone 2  
Zone 22

Exproof armatürler, tehlikeli gaz ve toz maddelerinin bulunduğu, patlama riski yüksek olan ortamlarda kullanılan armatürlerdir.

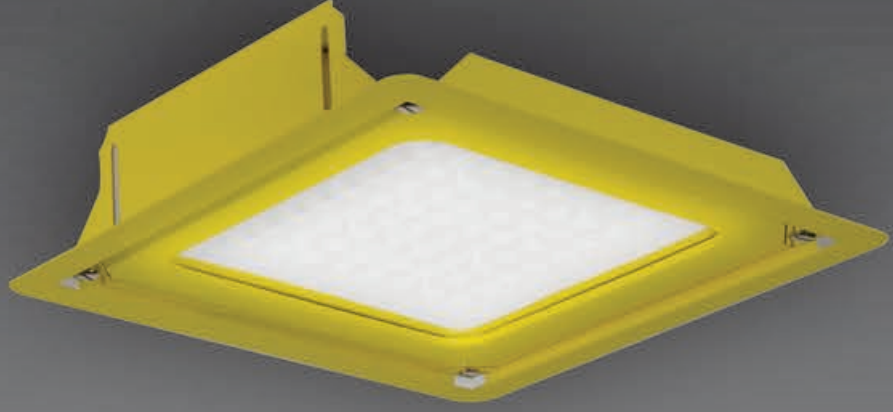

Petrol depolama, dolum boşaltım tesisleri, kimya ve boya tesisleri, endüstriyel üretim tesisleri, madenler gibi patlayıcı maddelerin bulunduğu alanlarda kullanılır.

### Piroliz – Exproof IP66 LED Kanopi Armatür

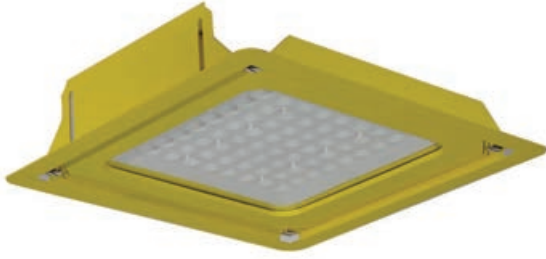

- **Gaz Patlama Koruması:**  II 3G Ex nR IIC T5 Gc
- **Toz Patlama Koruması:**  II 3D Ex tc IIIC (T95 C) Dc

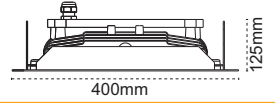

kod no	özellikler	koli adedi	fiyat
5616 4011	Piroliz Ex 50W 4000 / 6500K	1	575,00 \$
5616 4021	Piroliz Ex 75W 4000 / 6500K	1	650,00 \$
5616 4031	Piroliz Ex 100W 4000 / 6500K	1	725,00 \$
5616 4041	Piroliz Ex 125W 4000 / 6500K	1	800,00 \$

### Sia – Exproof IP66 LED Yüksek Tavan Armatür



- **Gaz Patlama Koruması:**  II 3G Ex nR IIC T5 Gc
- **Toz Patlama Koruması:**  II 3D Ex tc IIIC (T95 C) Dc

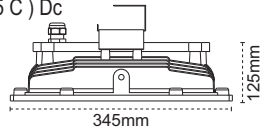

kod no	özellikler	koli adedi	fiyat
5616 4251	Sia Ex 50W 4000 / 6500K	1	575,00 \$
5616 4261	Sia Ex 75W 4000 / 6500K	1	650,00 \$
5616 4271	Sia Ex 100W 4000 / 6500K	1	725,00 \$
5616 4281	Sia Ex 125W 4000 / 6500K	1	800,00 \$

### Nairo – Exproof IP66 LED Projektör



- **Gaz Patlama Koruması:**  II 3G Ex nR IIC T5 Gc
- **Toz Patlama Koruması:**  II 3D Ex tc IIIC (T95 C) Dc

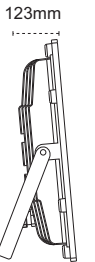

kod no	özellikler	koli adedi	fiyat
5616 3611	Nairo Ex 50W 4000 / 6500K	1	575,00 \$
5616 3621	Nairo Ex 75W 4000 / 6500K	1	650,00 \$
5616 3631	Nairo Ex 100W 4000 / 6500K	1	725,00 \$
5616 3641	Nairo Ex 125W 4000 / 6500K	1	800,00 \$



**Yüksek Binalar için  
IP65 Inoaled  
Wallwasher Çözümünüz!**

**S.Ü. Wallwasher  
Inoaled Projektör**

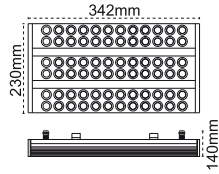

IP 65

kod no	özellikler	koli adedi	fiyat
5614 1211	60W 3000 / 4000 / 6500K	1	126,00 \$
5614 1231	90W 3000 / 4000 / 6500K	1	195,00 \$

**S.A. Wallwasher 50 cm  
IP65**

Konfigurasyon	Renk Seçenekleri
K154	3000K
K155	4000K
K156	6500K

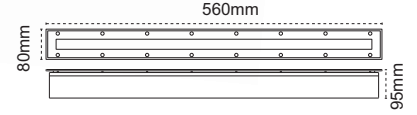

IP 65

kod no	özellikler	koli adedi	fiyat
5614 0651	18 Led'li 56 cm 4000K	1	85,00 \$

**S.A. Wallwasher 100 cm  
IP65**

Konfigurasyon	Renk Seçenekleri
K154	3000K
K155	4000K
K156	6500K

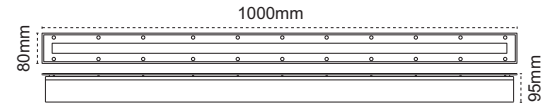

IP 65

kod no	özellikler	koli adedi	fiyat
5614 0641	36 Led'li 100 cm 4000K	1	133,00 \$



## Uzun Ömürlü, Yüksek Verimli Pelsan IP65 Wallwasher

- Çevre şartlarından etkilenmeyen IP65 alüminyum gövde
- Darbe dayanıklı, UV katkılı su geçirmez difüzör
- Ömrü boyunca sararmayan PMMA Avrupa lens
- Avrupa LED Çip
- Pelsan sabit akım driver
- Elektronik komponent ömrünü koruyan hava ventilli rakor



### S.Ü. Wallwasher IP65 Inoaled 30 cm 12 LED'li



Konfig	Renk	Fiyat
K172	Mavi	+7,35 \$
K170	Yeşil	+7,35 \$
K171	Kırmızı	+7,35 \$
K42	Amber	+7,35 \$
K69	RGB	+56,60 \$

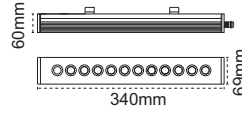

IP 65

kod no	özellikler	3000 / 4000 / 6500K	koli adedi	fiyat
5614 1011	15W 15 Derece	3000 / 4000 / 6500K	1	47,10 \$
5614 1041	15W 30 Derece	3000 / 4000 / 6500K	1	47,10 \$
5614 1071	15W 45+20 Derece	3000 / 4000 / 6500K	1	47,10 \$

### S.Ü. Wallwasher IP65 Inoaled 60 cm 24 LED'li



Konfig	Renk	Fiyat
K172	Mavi	+14,70\$
K170	Yeşil	+14,70\$
K171	Kırmızı	+14,70\$
K42	Amber	+14,70\$
K69	RGB	+64,90\$

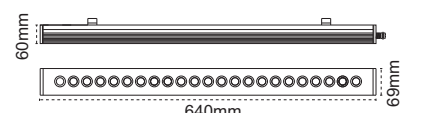

IP 65

kod no	özellikler	3000 / 4000 / 6500K	koli adedi	fiyat
5614 1021	30W 15 Derece	3000 / 4000 / 6500K	1	75,40 \$
5614 1051	30W 30 Derece	3000 / 4000 / 6500K	1	75,40 \$
5614 1081	30W 45+20 Derece	3000 / 4000 / 6500K	1	75,40 \$

### S.Ü. Wallwasher IP65 Inoaled 90 cm 36 LED'li



Konfig	Renk	Fiyat
K172	Mavi	+22,00 \$
K170	Yeşil	+22,00 \$
K171	Kırmızı	+22,00 \$
K42	Amber	+22,00 \$
K69	RGB	+88,90 \$

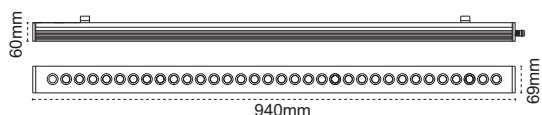

kod no	özellikler	3000 / 4000 / 6500K	koli adedi	fiyat
5614 1031	45W 15 Derece	3000 / 4000 / 6500K	1	113,10 \$
5614 1061	45W 30 Derece	3000 / 4000 / 6500K	1	113,10 \$
5614 1091	45W 45+20 Derece	3000 / 4000 / 6500K	1	113,10 \$

### S.Ü. Wallwasher IP65 Inoaled Performans



axbxcmm  
30W : 340x60x69  
60W : 640x60x69  
90W : 940x60x69

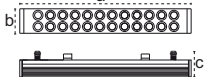

kod no	özellikler	3000 / 4000 / 6500K	koli adedi	fiyat
5614 1151	Çift Modül 30W 24 Led'li	3000 / 4000 / 6500K	1	59,00 \$
5614 1161	Çift Modül 60W 48 Led'li	3000 / 4000 / 6500K	1	109,00 \$
5614 1171	Çift Modül 90W 72 Led'li	3000 / 4000 / 6500K	1	139,00 \$



**Ria IP66 LED Projektör**

- 100lm/W'ın üzerinde verimlilik
- Avrupa LED Çip
- Simetrik ve asimetric ışık dağılımı
- 50.000 saat ömür
- Açılı ayarlanabilir konsol



Rio IP66 LED Projektör, müşterilerimizin isteğine göre kendini gecenin belirli bir saatinden sonra dimleyebilir. Bu özelliği ile LED'in sağladığı tasarrufa ekstra bir tasarruf sağlayarak enerji sarfiyatını minimuma düşürür.

**Ria IP66 Power**

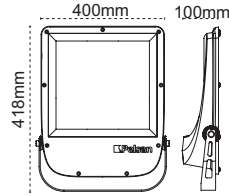

IP 66

kod no	özellikler	koli adedi	fiyat
5617 1701	100W Simetrik 4000K/6500K	1	151,00 \$
5617 1711	150W Simetrik 4000K/6500K	1	179,00 \$

**Ria IP66 Power**

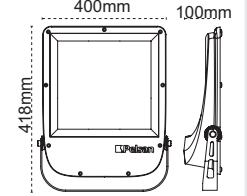

IP 66

kod no	özellikler	koli adedi	fiyat
5617 1752	100W Simetrik 4000K/6500K	1	187,00 \$
5617 1762	125W Simetrik 4000K/6500K	1	205,00 \$
5617 1772	150W Simetrik 4000K/6500K	1	224,00 \$



- Avrupa Driver

**Ria IP66 Simetrik**

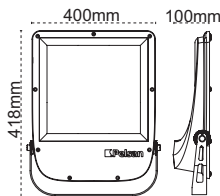

IP 66

kod no	özellikler	koli adedi	fiyat
5617 1881	180W Simetrik 4000K/6500K	1	264,00 \$
5617 1891	200W Simetrik 4000K/6500K	1	302,00 \$
5617 1731	240W Simetrik 4000K/6500K	1	377,00 \$

**Ria IP66 Asimetrik**

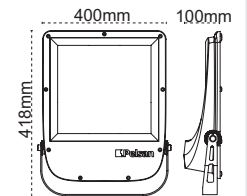

IP 66

kod no	özellikler	koli adedi	fiyat
5617 1831	180W Asimetrik 4000K/6500K	1	264,00 \$
5617 1841	200W Asimetrik 4000K/6500K	1	302,00 \$
5617 1721	240W Asimetrik 4000K/6500K	1	377,00 \$

**Ria IP66 Power Lux**

- Avrupa Driver

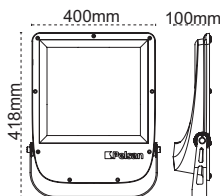

IP 66

kod no	özellikler	koli adedi	fiyat
5616 3571	140W Simetrik 4000K/6500K	1	392,00 \$

**Ria IP66 Power Lux**

- Avrupa Driver

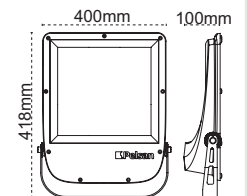

IP 66

kod no	özellikler	koli adedi	fiyat
5616 3581	215W Simetrik 4000K/6500K	1	447,00 \$

## Liya

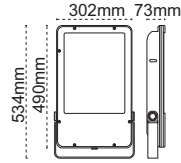

IP 65

kod no	özellikler	koli adedi	fiyat
5615 6731	103W Simetrik 4000K/6500K	1	357,00 \$
5615 6732	154W Simetrik 4000K/6500K	1	394,00 \$
5615 6733	180W Simetrik 4000K/6500K	1	451,00 \$

## Inoaled Projektör

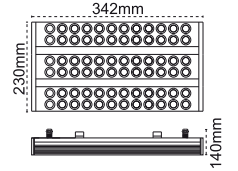

IP 65

kod no	özellikler	koli adedi	fiyat
5614 1221	60W	1	126,00 \$
5614 1241	90W	1	195,00 \$

## Forino

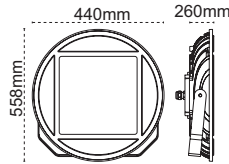

IP 65

kod no	özellikler	koli adedi	fiyat
5616 3961	103W 64 Led'li 4000K/6500K	1	330,00 \$

## Forino Med



5616 3972



5616 3981

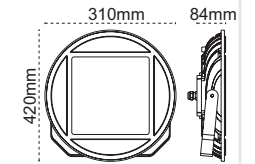

IP 65

kod no	özellikler	koli adedi	fiyat
5616 3972	59W 4000K/6500K	1	196,00 \$
5616 3981	65W 4000K/6500K (Prizmatik Camlı)	1	170,00 \$

## Nairo

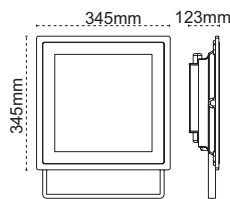

IP 65

kod no	özellikler	koli adedi	fiyat
5616 3671	75W 4000K/6500K	1	255,00 \$
5616 3681	100W 4000K/6500K	1	295,00 \$
5616 3791	125W 4000K/6500K	1	340,00 \$

## Yağmur Altı

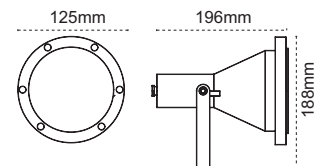

IP 65

kod no	özellikler	koli adedi	fiyat
5615 4001	12x1W 4000 / 6500 K	20	67,00 \$

## Franko 100W

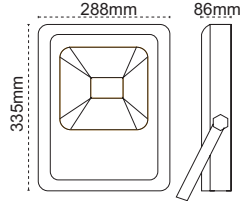

IP 65

kod no	özellikler	koli adedi	fiyat
5617 1091	100W 6500K	4	75,40 \$

## Franko 70W

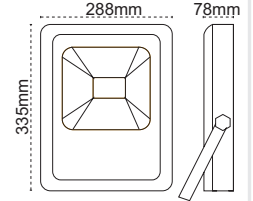

IP 65

kod no	özellikler	koli adedi	fiyat
5617 1081	70W 6500K	4	54,60 \$

## Franko 50-30W



axbxcmm  
30W/223x85x50  
50W/285x230x65

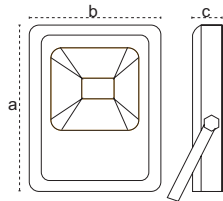

IP 65

kod no	özellikler	koli adedi	fiyat
5617 1071	50W 6500K	6	33,95 \$
5617 1051	30W 6500K	10	24,50 \$
5615 6790	30W Yeşil COB LED	10	28,30 \$

## Franko 20-10W



axbxcmm  
10W/110x84x38  
20W/180x140x45

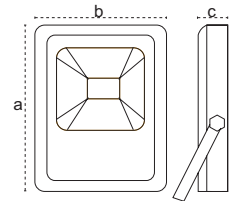

IP 65

kod no	özellikler	koli adedi	fiyat
5617 1041	20W 6500K	20	18,90 \$
5617 1031	10W 6500K	40	11,35 \$

## Franko 30-20W Sensörlü



axbxcmm  
20W/255x140x45  
30W/305x190x50

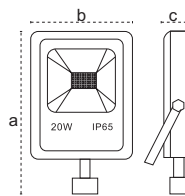

IP 65

kod no	özellikler	koli adedi	fiyat
5617 1621	20W Sensörlü 6500K	10	28,30 \$
5617 1631	30W Sensörlü 6500K	20	35,90 \$

## Franko Seyyar - Projektör Ayağı

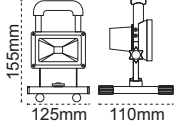

IP 65 10W, 20W, 30W ve 50 W projektör için uygundur.

kod no	özellikler	koli adedi	fiyat
5617 1671	10W Şarj Edilebilir Franko 6500K	10	33,00 \$
5617 1110	Projektör Tripot	4	28,30 \$

## Beyan Ettiği Güç ve Lümeni Verir!

### Franko Projektör

- Ömrü boyunca aynı lümen çıktısı
- 88 lm/W'ın üzerinde etkinlik faktörü
- 30.000 saat ömür
- Alüminyum gövde
- Ayarlanabilir konsol
- Toz ve su almaz, IP65



### Franko 400W

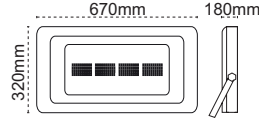

IP 65

kod no	özellikler	koli adedi	fiyat
5617 1411	400W 5000K	1	452,00 \$
4065 527	400W Tel Kafes	1	13,00 \$

### Franko 300-250W

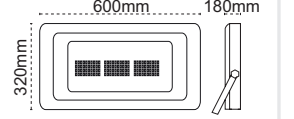

IP 65

kod no	özellikler	koli adedi	fiyat
5617 1401	300W 5000K	1	340,00 \$
5617 1391	250W 5000K	1	255,00 \$
4065 526	300W-250W Tel Kafes	1	13,00 \$

### Franko 200W

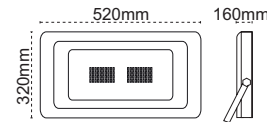

IP 65

kod no	özellikler	koli adedi	fiyat
5617 1381	200W 5000K	1	177,00 \$
4065 525	200W Tel Kafes	1	13,00 \$

### Franko 150W

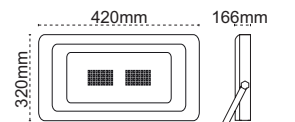

IP 65

kod no	özellikler	koli adedi	fiyat
5617 1371	150W 5000K	2	132,00 \$
4065 524	150W Tel Kafes	1	13,00 \$

**Olimpiad 1000W-400w**  
Simetrik  
Fiberglass

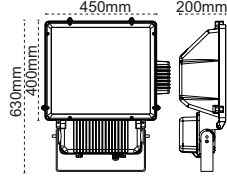

IP 65

kod no	özellikler	koli adedi	fiyat
5611 1081	1000W Metal, MH/SB	1	569,00 ₺
5612 1062	400W Metal MH	1	285,00 ₺

**Euro 1000W Simetrik**  
Alüminyum Enjeksiyon

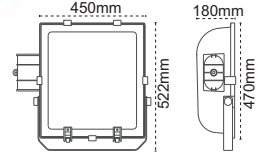

IP 65

kod no	özellikler	koli adedi	fiyat
5611 2701	1000 W Metal, HPI-T	1	378,00 \$

**Stad 1000-2000W Simetrik**  
Alüminyum Enjeksiyon

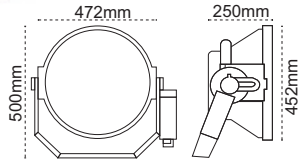

IP 65

kod no	özellikler	koli adedi	fiyat
5611 4201	1000W/230 V MH	1	651,00 \$
5611 4202	2000W/380 V MH	1	661,00 \$

**Marco 1000-2000W Simetrik**  
Alüminyum Enjeksiyon

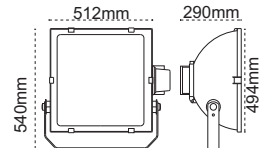
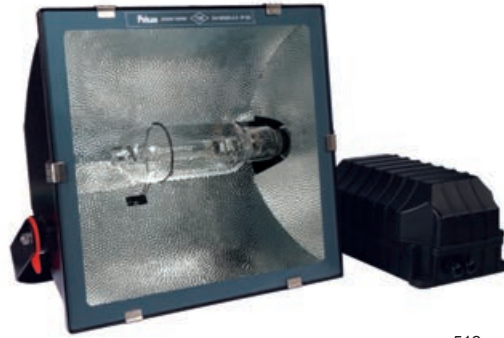

IP 66

kod no	özellikler	koli adedi	fiyat
5611 2801	1000W MH/SB E40	1	540,00 \$
5611 2802	2000W / 380 V Metal E40	1	551,00 \$

**Bolivo 1000-2000W Asimetrik**  
Alüminyum Enjeksiyon

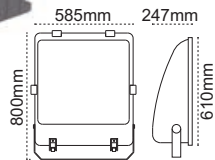

IP 65

kod no	özellikler	koli adedi	fiyat
5611 2511	1000W Asimetrik E40	1	446,00 \$
5611 2512	2000W Asimetrik MHN-LA	1	456,00 \$

**Davos Asimetrik**  
Fiberglass

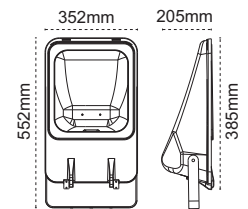

IP 65

kod no	özellikler	koli adedi	fiyat
5611 4512	150W RX7S	1	60,00 \$

### Yeno 250-400W Simetrik Fiberglass

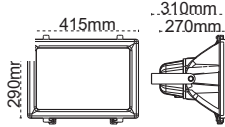

IP 65

kod no	özellikler	koli adedi	fiyat
5611 1611	250W MH/SB HPI-T	2	208,50 ₺
5611 1613	400W SB SON-T	2	228,50 ₺
5611 1612	400W MH HPI-T	2	214,50 ₺

### Levo Alüminyum Enjeksiyon

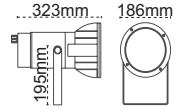

IP 65

kod no	özellikler	koli adedi	fiyat
5321 1711	70W Metal CDM-T	4	58,75 \$
5321 1712	150W Metal CDM-T	4	62,75 \$
5999 5071	25W Levo LED	4	108,00 \$

### Elit Semiad 70-150W Asimetrik Fiberglass

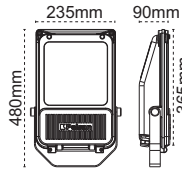

IP 65

kod no	özellikler	koli adedi	fiyat
5321 1801	70W MH/SB MHN-TD	4	34,00 \$
5321 1802	150W MH/SB MHN-TD	4	37,60 \$

### Elit Lirad 70-150W Simetrik Fiberglass

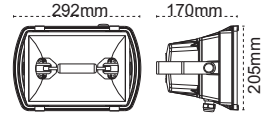

IP 65

kod no	özellikler	koli adedi	fiyat
5321 1901	70W MH/SB MHN-TD	6	34,00 \$
5321 1902	150W MH/SB MHN-TD	6	37,60 \$

### Elit Pesato 250-400W Asimetrik Fiberglass

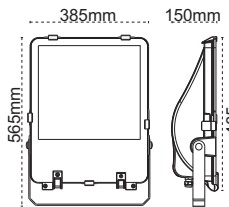

IP 65

kod no	özellikler	koli adedi	fiyat
5611 1801	250W MH/SB HPI-T	1	66,60 \$
5611 1802	400W MH HPI-T	1	68,00 \$
5611 1803	400W SB SON-T	1	71,80 \$

### Tünel 250-400W Alüminyum Enjeksiyon

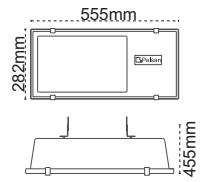

IP 65

kod no	özellikler	koli adedi	fiyat
5322 1011	250W MH/SB E40	1	147,00 \$
5322 1012	400W SB E40	1	153,00 \$

### Lima

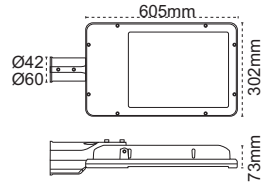

IP 65

kod no	özellikler	koli adedi	fiyat
5615 6781	103W 4000 / 6500K	1	375,00 \$
5615 6782	154W 4000 / 6500K	1	431,00 \$
5615 6783	180W 4000 / 6500K	1	489,00 \$

### Tokyo

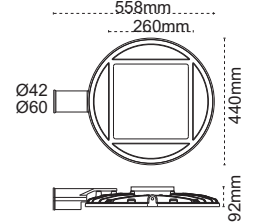

IP 65

kod no	özellikler	koli adedi	fiyat
5616 3841	77W 4000 / 6500K	1	281,00 \$
5616 3861	103W 4000 / 6500K	1	356,00 \$

### Bari

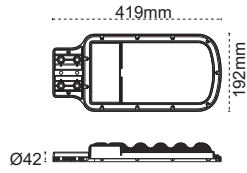

IP 65

kod no	özellikler	koli adedi	fiyat
5615 5811	42W 4000K	2	82,50 \$

### Tokyo Med

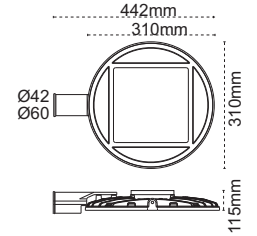

IP 65

kod no	özellikler	koli adedi	fiyat
5616 3871	39W 4000 / 6500K	1	187,00 \$
5616 3872	59W 4000 / 6500K	1	196,00 \$

### Seul LED

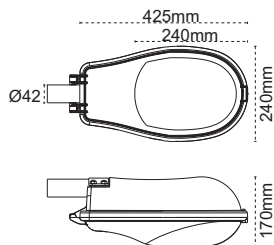

IP 65

kod no	özellikler	koli adedi	fiyat
5615 6801	30W 4000K	1	60,90 \$

### Katener Armatürler

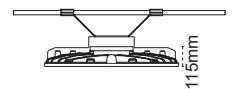

IP 65

kod no	özellikler	koli adedi	fiyat
5616 3873	Katener Tokyo Med 39W 4000 / 6500K	1	189,00 \$
5616 3874	Katener Tokyo Med 59W 4000 / 6500K	1	199,00 \$
5616 3881	Katener Tokyo 103W 4000 / 6500K	1	359,00 \$



**TEDAŞ  
Şartnamelerine  
Uygun**



## Rio Yol Aydınlatma Armatürü

M1 - M2 - M3 - M4 - M5 yol sınıflarına uygun.

Otomatik dim programlama opsiyonu ile ayarlanabilir ışık seviyesi

- Avrupa LED çip ve Avrupa driver
- 120 lm/W Etkinlik Faktörü
- 45W'dan 240W'a kadar güç seçeneği
- 0° - 5° - 10° - 15° ayarlanabilir konsol
- -40 / +50 °C ortam koşulunda çalışır
- Toz ve su almaz, IP66 koruma sınıfı
- Darbelere dayanıklı IK09 koruma sınıfı

### Rio IP66 120 LED'li

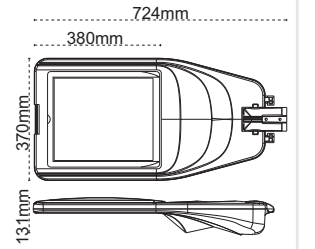

IP 66

kod no	özellikler	koli adedi	fiyat
5616 5791	200W 120 LED'li 4000 / 6500K	1	449,00 \$
5616 5721	240W 120 LED'li 4000 / 6500K	1	489,00 \$

### Rio IP66 80 LED'li

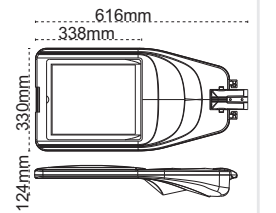

IP 66

kod no	özellikler	koli adedi	fiyat
5616 5751	100W 80 LED'li 4000 / 6500K	1	299,00 \$
5616 5741	140W 80 LED'li 4000 / 6500K	1	339,00 \$

### Rio IP66 36 LED'li

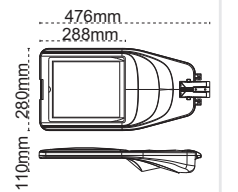

IP 66

kod no	özellikler	koli adedi	fiyat
5616 5611	45W 36 LED'li 4000 / 6500K	1	189,00 \$
5616 5621	65W 36 LED'li 4000 / 6500K	1	209,00 \$

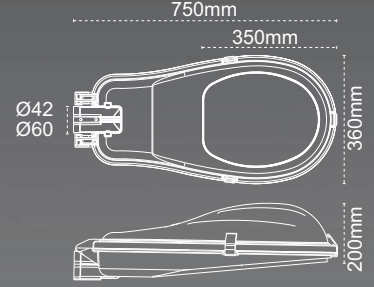

**Roma IP66**  
Polimer Enjeksiyon

IP 66

kod no	özellikler	koli adedi	fiyat
5211 6313	250W SB SON-T	1	297,50 ₺
5211 6314	400W SB SON-T	1	326,50 ₺

**Riga-Sofia**  
Polimer Enjeksiyon

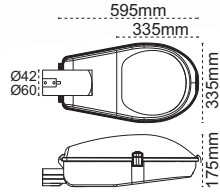

IP 65

kod no	özellikler	koli adedi	fiyat
5211 6011	Riga 50 W Sodyum SON-T	2	157,50 ₺
5211 6012	Riga 70 W Sodyum SON-T	2	167,50 ₺
5211 6211	Sofia 100 W Sodyum SON-T	2	179,00 ₺
5211 6212	Sofia 150 W Sodyum SON-T	2	209,50 ₺

**Seul**  
Polimer Enjeksiyon

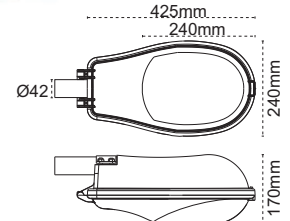

IP 65

kod no	özellikler	koli adedi	fiyat
5211 6411	65W Boş PLE	5	44,00 ₺

**Ibiza**  
Fiberglass

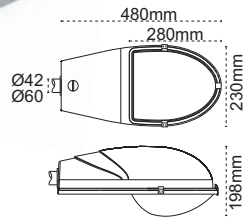

IP 54 / 43

kod no	özellikler	koli adedi	fiyat
5211 3242	85 W Boş PLE	5	63,00 ₺
5211 3240	160 W Boş ML	5	63,00 ₺
5211 3241	125 W Civa HPL-N	5	103,00 ₺
5211 3244	70 W Sodyum SON-T	5	132,50 ₺

**Corfu**  
Fiberglass

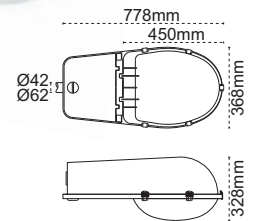

IP 54 / 43

kod no	özellikler	koli adedi	fiyat
5211 1110	250W Boş ML	1	142,00 ₺
5211 1116	250W Civa HPL-N	1	196,00 ₺
5211 1115	250W Sodyum SON-T	1	240,00 ₺
5211 1118	400W Sodyum SON-T	1	275,00 ₺

## Lyon Alüminyum Enjeksiyon

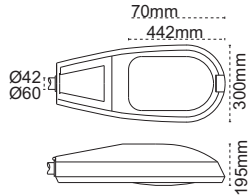

IP 65 / 43

kod no	özellikler	koli adedi	fiyat
5211 5011	100 W Sodyum SON-T	1	433,50 ₺
5211 5012	150 W Sodyum SON-T	1	447,50 ₺
5211 5013	250 W Sodyum SON-T	1	462,50 ₺
5211 5014	400 W Sodyum SON-T	1	476,00 ₺

## Parma Alüminyum

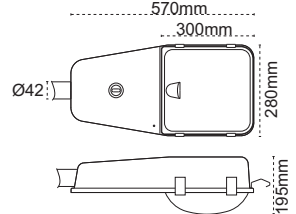

IP 54 / 43

kod no	özellikler	koli adedi	fiyat
5211 1010	160W Bo_ML	5	122,50 ₺
5211 1013	125W Civa HPL-N	5	145,50 ₺
5211 1014	150W Sodyum SON-T	5	222,00 ₺

## Bakü Temperli Camlı Alüminyum

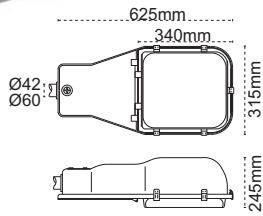

IP 65 / 43

kod no	özellikler	koli adedi	fiyat
5211 1613	150W Sodyum SON-T	1	284,50 ₺
5211 1614	250W Sodyum SON-T	1	313,00 ₺
5211 1616	400W Sodyum SON-T	1	327,00 ₺

## Como - Kiev Alüminyum

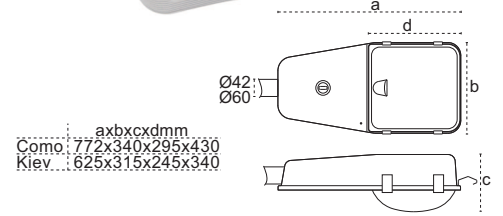

IP 54

kod no	özellikler	koli adedi	fiyat
5211 1131	Como 250W MH/SB	1	301,50 ₺
5211 1135	Como 400W Sodyum E40	1	314,00 ₺
5211 1133	Como 400W MH	1	301,50 ₺
5211 3010	Kiev 250W Boş E40	1	164,00 ₺
5211 3014	Kiev 250W Sodyum E40	1	273,50 ₺

## Davos Fiberglass

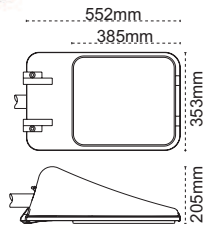

IP 65

kod no	özellikler	koli adedi	fiyat
5211 3314	150W SON E40	1	60,00 \$
5211 3316	150W MH R7S	1	60,00 \$
5211 3319	70W MH RX7S	1	56,25 \$
4101 586	A1 Konsol	1	11,50 ₺
4101 587	A2 Konsol	1	16,50 ₺

## Konsollar

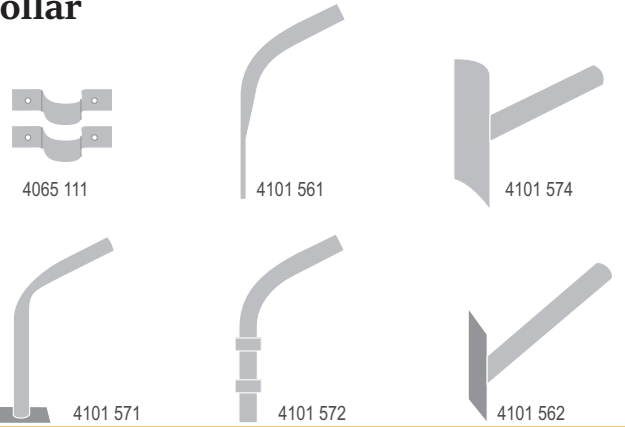

IP 40

kod no	özellikler	koli adedi	fiyat
4101 551	Konsol Boru 60cm	25	16,50 ₺
4101 561	Duvar Tipi Konsol Boru 60cm Ø42	25	25,00 ₺
4101 574	Ø60 Direk Tipi Konsol Boru	1	25,00 ₺
4101 571	Set Üstü Konsol 60cm	1	25,00 ₺
4101 572	Kelepçeli Konsol	1	25,00 ₺
4101 562	Duvar Tipi Konsol Boru 30cm Ø42	1	25,00 ₺
3035 451	60/42 Konsol Adaptörü	1	33,00 ₺
4065 111	Boru Kelepçe	1	6,60 ₺

## Doğadan Gelen Güç!

### Rio Solar

- Enerji hatlarının bulunmadığı mekanlara ekonomik çözüm
- Gün içinde depoladığı enerji ile 2 gün aydınlatma
- Komple sistem çözümü

### Rio Solar

IP 65

kod no	özellikler	koli adedi	fiyat
5616 5651	20W 36 Led'li Sokak Armatürü	1	209,00 \$
5616 5661	40W 36 Led'li Sokak Armatürü	1	229,00 \$

### Rio Solar Armatür

- ▶ Avrupa LED Çip
- ▶ Yüksek verimli driver
- ▶ Avrupa lens
- ▶ 100 lm/W üzeri verimlilik

### Rio Solar Sistem

kod no	özellikler	koli adedi	fiyat
5514 5011	20W Solar Komple Sistem (Armatür-Sistem-4m Direk)	1	1078,00 \$
5514 5021	40W Solar Komple Sistem (Armatür-Sistem-4m Direk)	1	1778,00 \$

### Solar Panel

- ▶ Yüksek verimli monokristal panel
- ▶ Çevre şartlarına dayanımlı IP65 terminal kutusu
- ▶ Güneşi toplayan özel yüzey
- ▶ Kendisini temizleyen, kir tutmayan panel dokusu
- ▶ Yaşlanmaya karşı EVA film koruma

### Batarya

- ▶ Uzun ömürlü, bakım gerektirmeyen JEL batarya
- ▶ Düşük iç direnci sayesinde yüksek performans
- ▶ Çevre şartlarına dayanımlı yapı

### Solar Şarj Cihazı

- ▶ Özel yazılımı ile en ideal şarj modunu seçer.
- ▶ Voltaj - Akım kontrolü sağlar, sistem ömrünü uzatır.
- ▶ Solar panelden gelen akımı kontrol eder.
- ▶ Akü ömrünü uzatır.



Park Bahçe  
Yönetmeliğine  
Uygun

## Soho

- Gece 2'den sonra otomatik %50 dim opsiyonu
- Avrupa LED Çip , Avrupa driver
- Modüler Tasarım

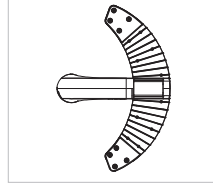

**Soho 1**  
Tekli Modül Montaj

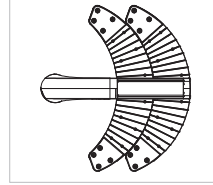

**Soho 2**  
İkili Modül Montaj

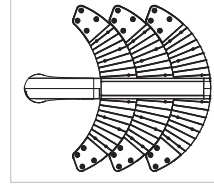

**Soho 3**  
Üçlü Modül Montaj

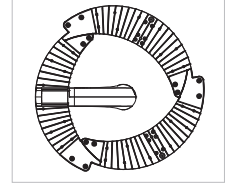

**Soho 4**  
Üçlü Modül Montaj

IP Sınıfı	IP 65
Gövde	Alüminyum
Önerilen Uygulama Yüksekliği	4 - 6 m
LED Çip	Avrupa LED Çip
LED Driver	Avrupa Driver
Konsol Çapı	76 mm

## Zaman Ayarı Opsiyonu

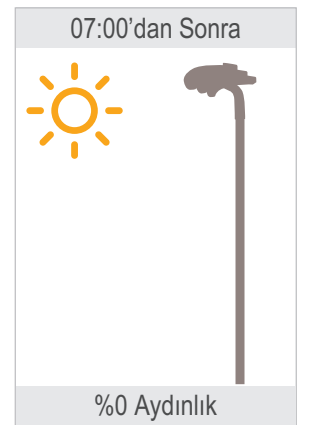

## Soho

IP 65

kod no	özellikler	koli adedi	fiyat
5740 1501	Soho 1 25W LED 4000 / 6500K 4m direkli	1	575,00 \$
5740 1521	Soho 2 50W LED 4000 / 6500K 4m direkli	1	630,00 \$
5740 1541	Soho 3 75W LED 4000 / 6500K 4m direkli	1	690,00 \$
5740 1561	Soho 4 75W LED 4000 / 6500K 4m direkli	1	660,00 \$

# Pelsan Park Bahçe Aydınlatma Armatürleri

## Davos



IP 65

kod no	özellikler	koli ad.	fiyat
5611 4512	150W Rx7S	1	60,00 \$
4101 512	B1 Konsol	1	16,50 \$
4101 513	B2 Konsol	1	11,50 \$

## Datça

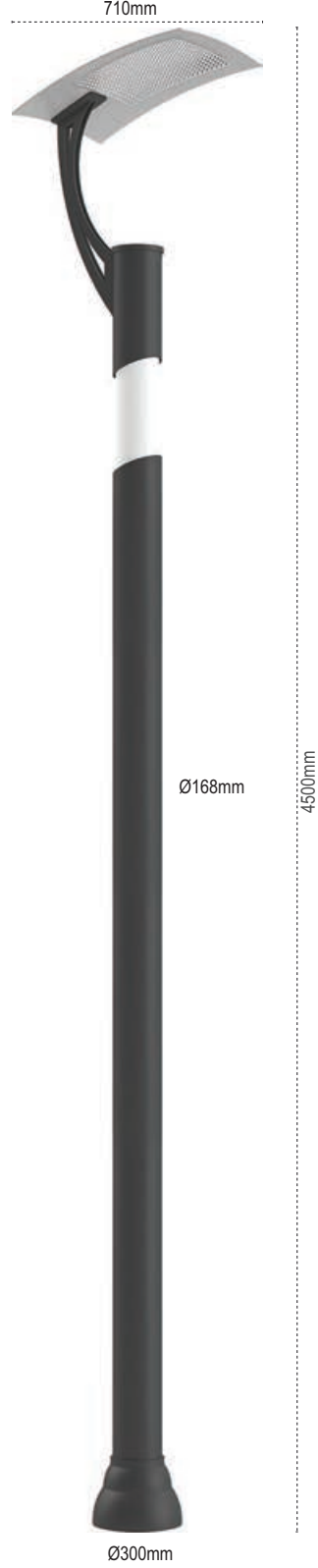

IP 65

kod no	özellikler	koli adedi	fiyat
5723 1011	150W G12	1	494,00 \$
5723 0810	30W LED'li	1	672,00 \$
5985 9810	RGB Kontrol Cihazı	1	20,40 \$

## Kos

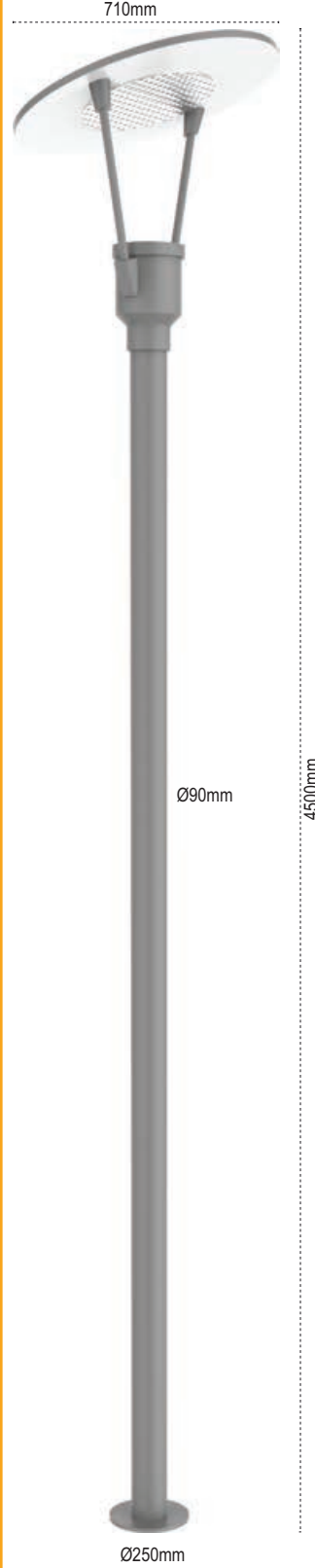

IP 65

kod no	özellikler	koli adedi	fiyat
5723 1311	150W G12	1	430,00 \$
5723 1312	150W Rx7S	1	472,00 \$

## Samos

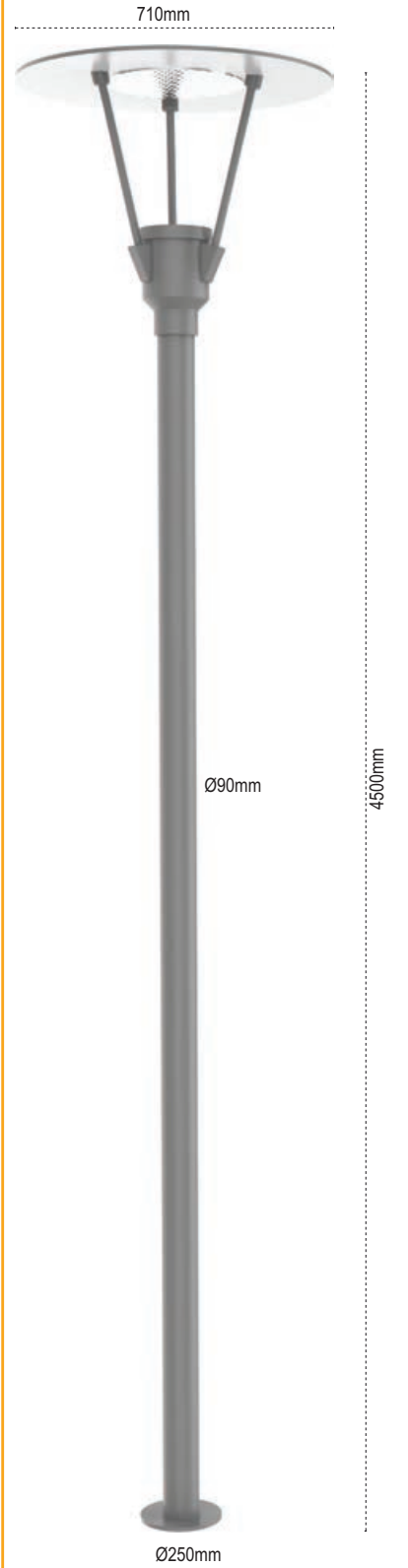

IP 65

kod no	özellikler	koli adedi	fiyat
5740 1321	150W G12	1	451,00 \$
5740 1330	50W COB LED	1	529,00 \$

# LED Park Bahçe Aydınlatma Armatürleri

## Borneo



\* Hareket sensörlüdür.  
Hareket algılanmadığında  
%50 güç ile çalışır.  
Hareket algılandığında  
%100 güç ile çalışır.

IP 65 ⊕

kod no	özellikler	koli adedi	fiyat
5616 5431	64W LED'li 6500K	1	659,00 \$

## Limra LED

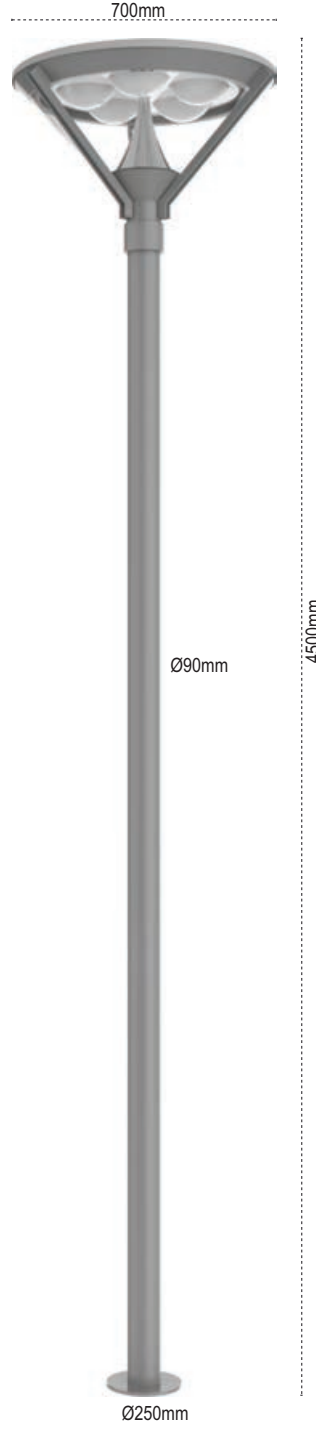

IP 65 ⊕

kod no	özellikler	koli adedi	fiyat
5711 2632	150W E40	1	410,00 \$
5711 3051	38W 3 LED'li	1	525,00 \$
5711 3021	80W 5 LED'li	1	614,00 \$

## Patras LED

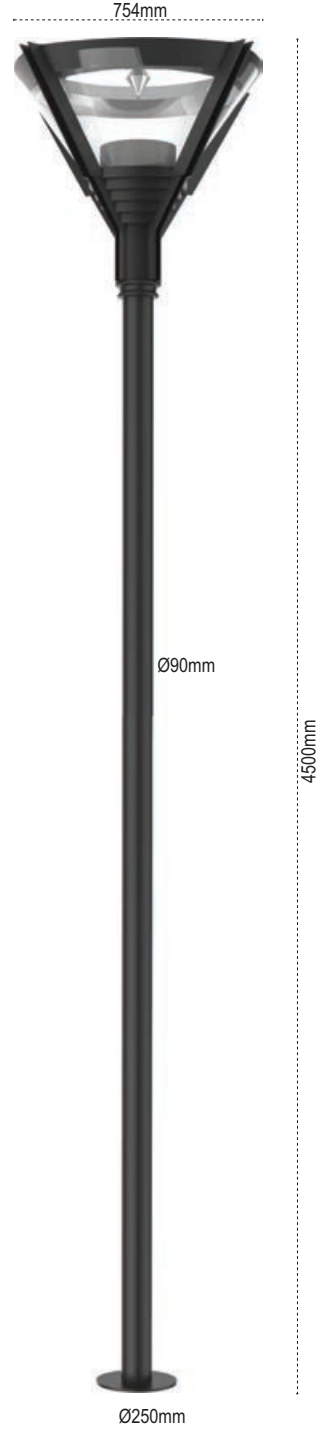

IP 65 ⊕

kod no	özellikler	koli adedi	fiyat
5740 1031	150W Rx7S	1	614,00 \$
5615 6824	68W LED'li	1	650,00 \$

## Verde



IP 65 ⊕

kod no	özellikler	koli adedi	fiyat
5616 5411	68W LED'li 6500K	1	659,00 \$

# Pelsan LED Park Bahçe Aydınlatma Armatürleri

## Evaled

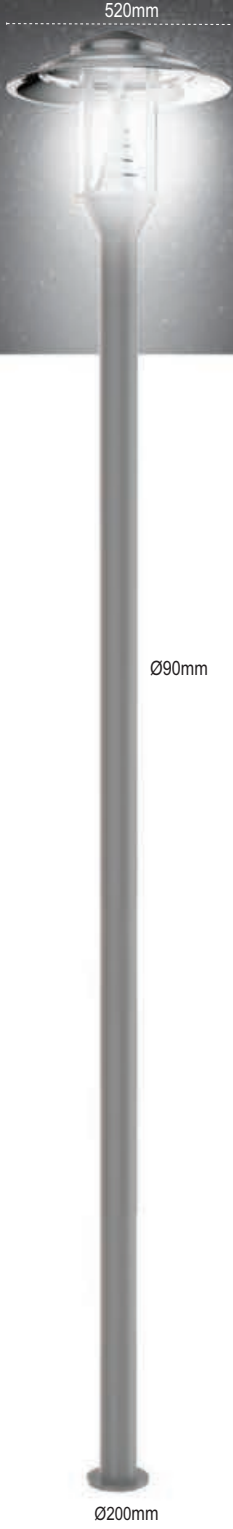

3500mm



IP 65

kod no	özellikler	koli adedi	fiyat
5711 3061	40W LED'li	1	378,00 \$

## Mesaled

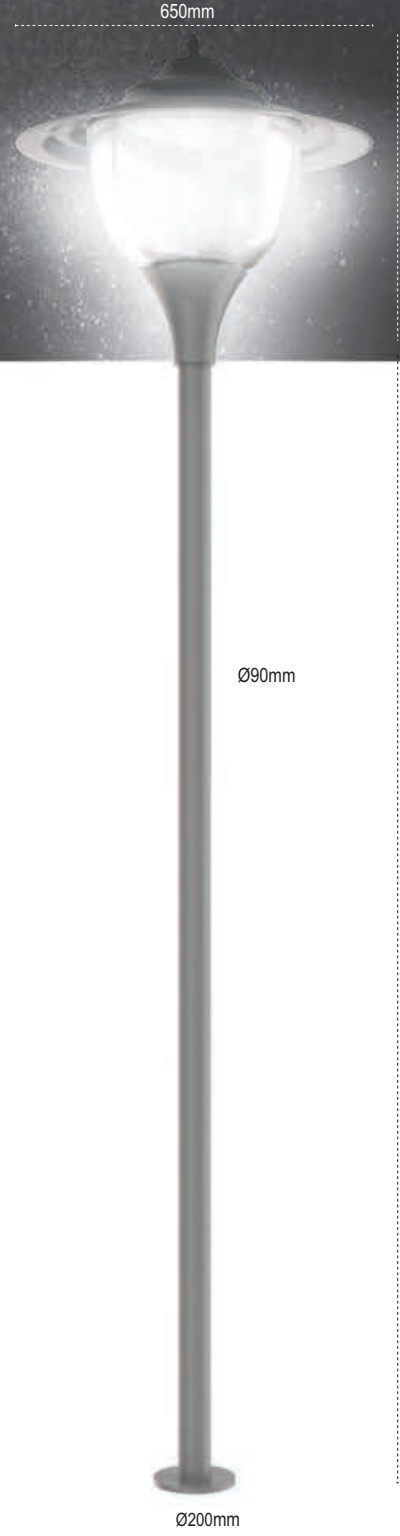

3500mm

IP 65

kod no	özellikler	koli adedi	fiyat
5711 3081	30W LED'li	1	283,00 \$
5711 3091	60W LED'li	1	305,00 \$
5711 3101	60 / 30W LED'li	1	340,00 \$



## Olimpos R

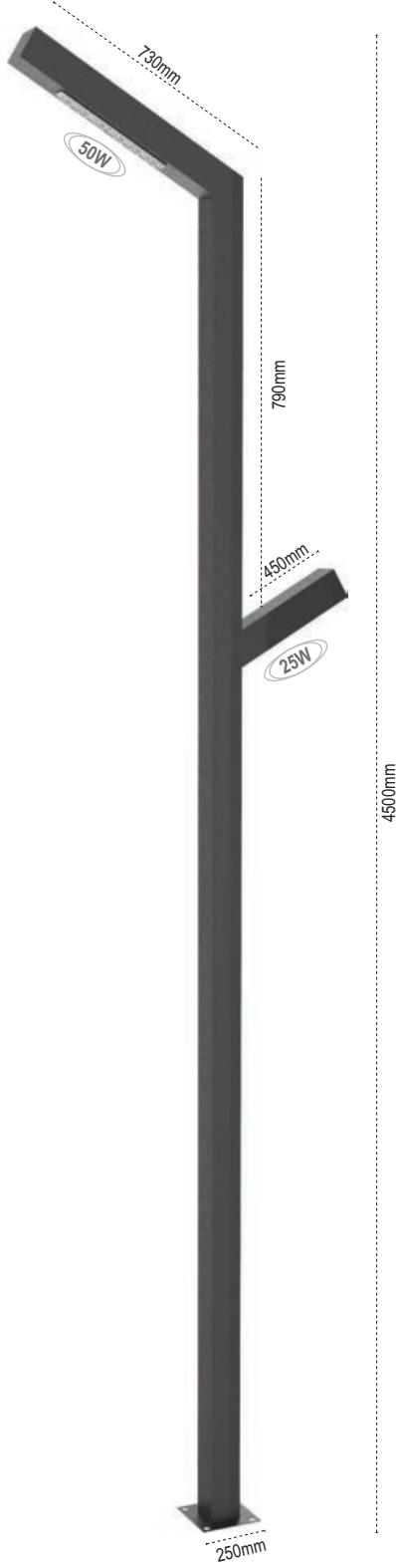

Size özel Olimpos tasarımlar için satış temsilcimize danışınız.

IP 65 ☹

kod no	özellikler	koli adedi	fiyat
5730 1371	75W LED'li	1	755,00 \$
5714 1381	50W LED'li	1	695,00 \$

## Olimpos T

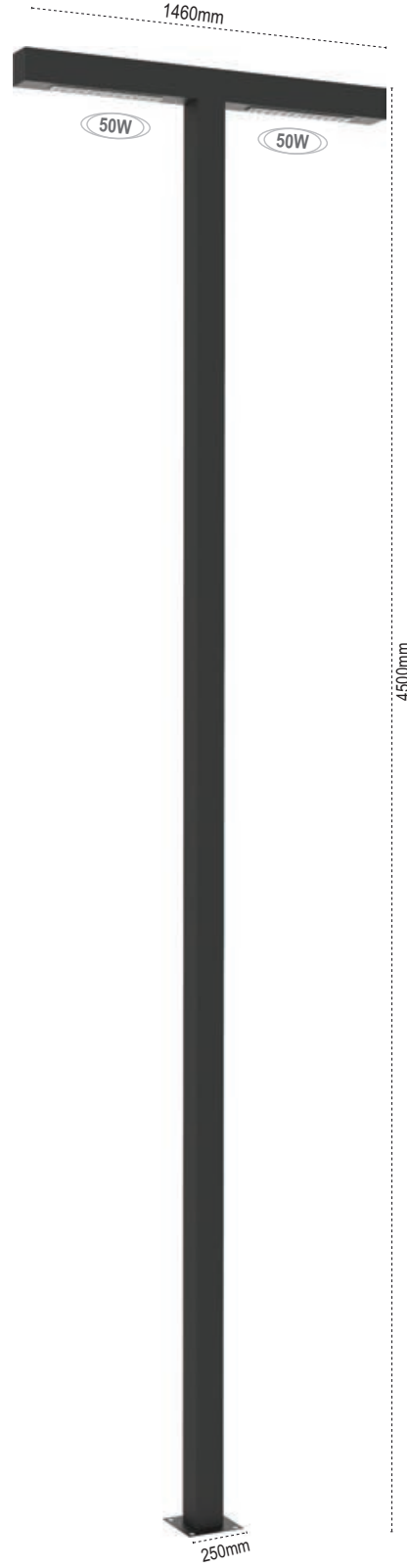

Size özel Olimpos tasarımlar için satış temsilcimize danışınız.

IP 65 ☹

kod no	özellikler	koli adedi	fiyat
5714 1391	100W LED'li	1	815,00 \$

## Olimpos T

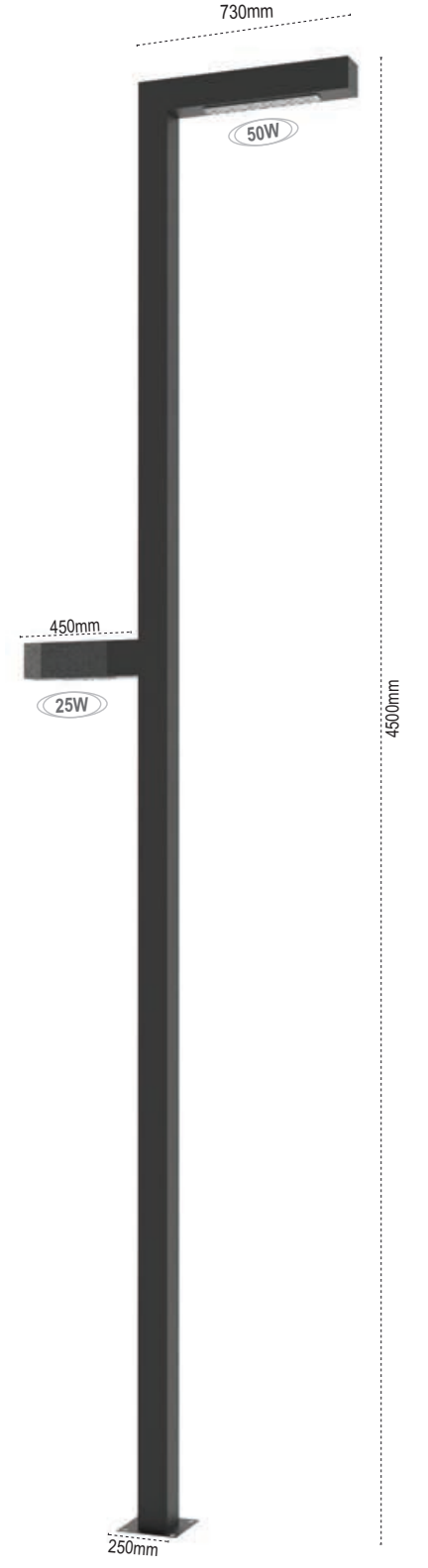

Size özel Olimpos tasarımlar için satış temsilcimize danışınız.

IP 65 ☹

kod no	özellikler	koli adedi	fiyat
5714 1401	75W LED'li	1	755,00 \$
5714 1411	50W LED'li	1	695,00 \$

# Pelsan LED Park Bahçe Aydınlatma Armatürleri

Alinda



kod no	özelliikle	koli adedi	fiyat
5714 1311	25W LED'li	1	510,00 \$

Misis

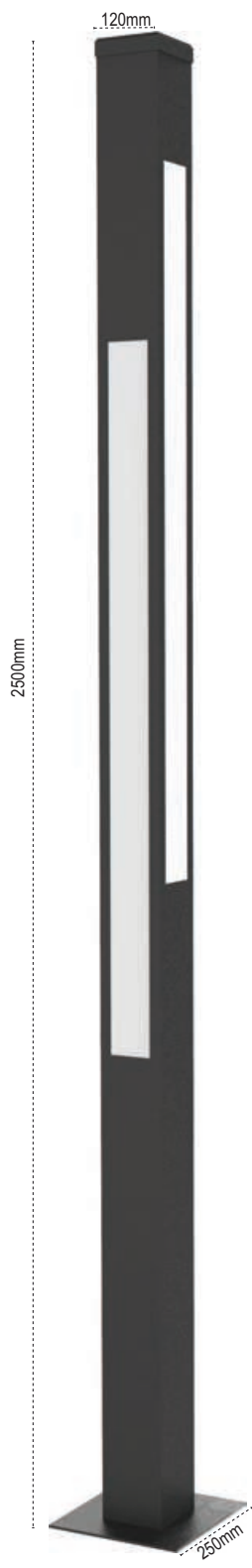

kod no	özelliikle	koli adedi	fiyat
5714 1331	100W LED'li	1	650,00 \$

Assos

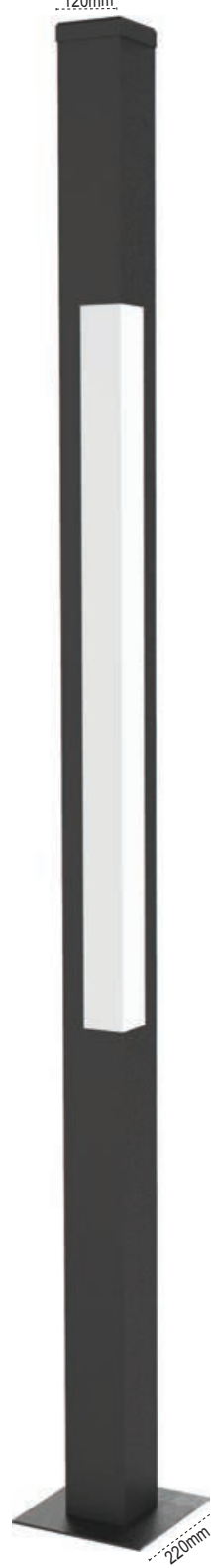

kod no	özelliikle	koli adedi	fiyat
5714 1321	100W LED'li	1	650,00 \$

Milas



kod no	özelliikle	koli adedi	fiyat
5615 4731	1000W LED'li	1	570,00 \$

## Mindos

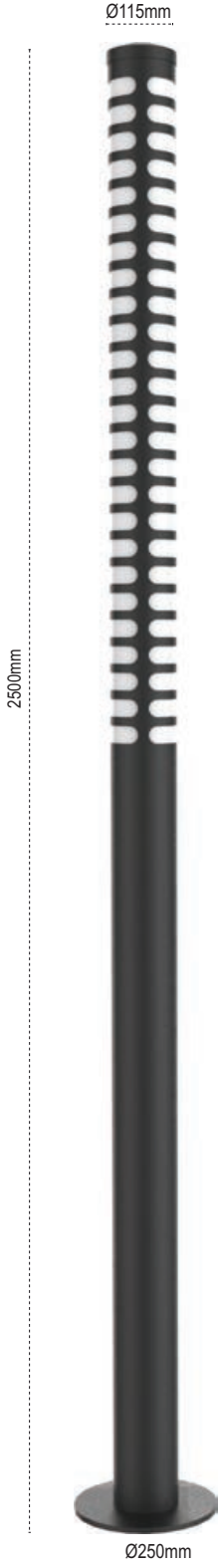

IP 65

kod no	özellikler	koli adedi	fiyat
5714 1341	125W LED'li	1	650,00 \$

## Patara



IP 65

kod no	özellikler	koli adedi	fiyat
5714 1351	125W LED'li	1	650,00 \$

## Sedir

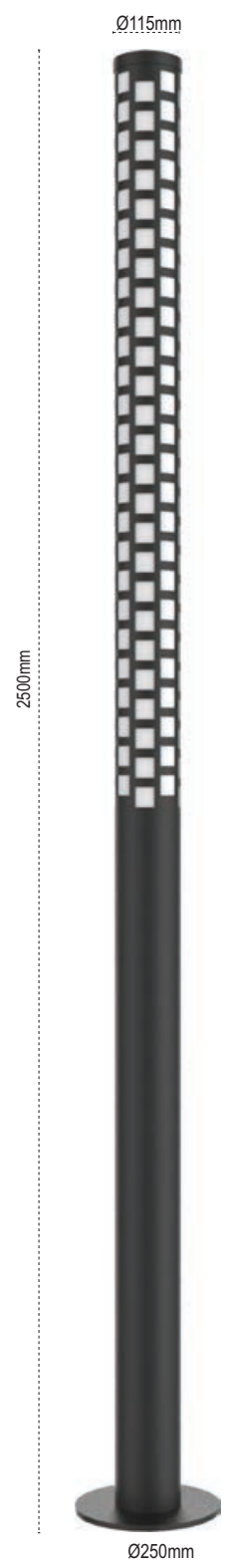

IP 65

kod no	özellikler	koli adedi	fiyat
5714 1361	125W LED'li	1	650,00 \$

**Milet**

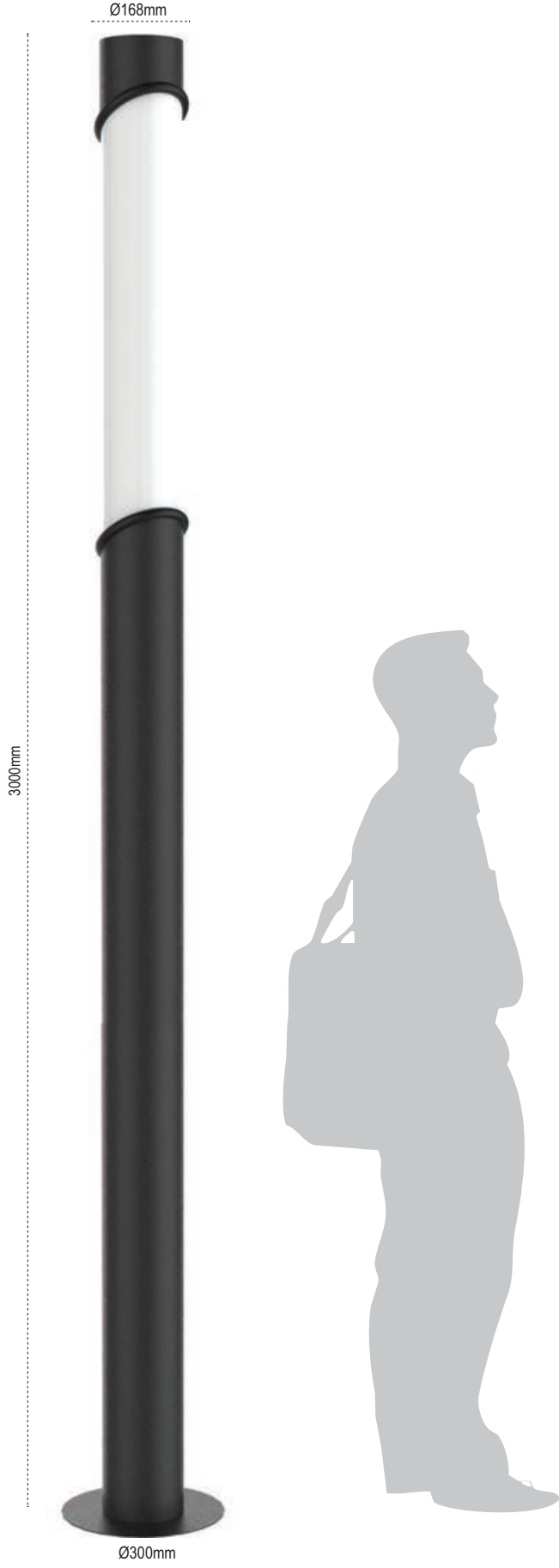

**Bitez**



IP 65

kod no	özellikler	koli adedi	fiyat
5615 4761	60W LED'li	1	475,00 \$

IP 65

kod no	özellikler	koli adedi	fiyat
5615 4711	100W LED'li	1	410,00 \$

## Temı

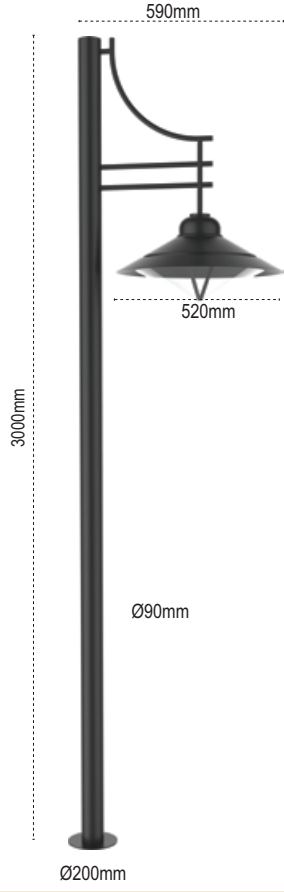

IP 54

kod no	özellikler	koli adedi	fiyat
5715 1260	Temı Direk	1	119,00 \$

## Ruso

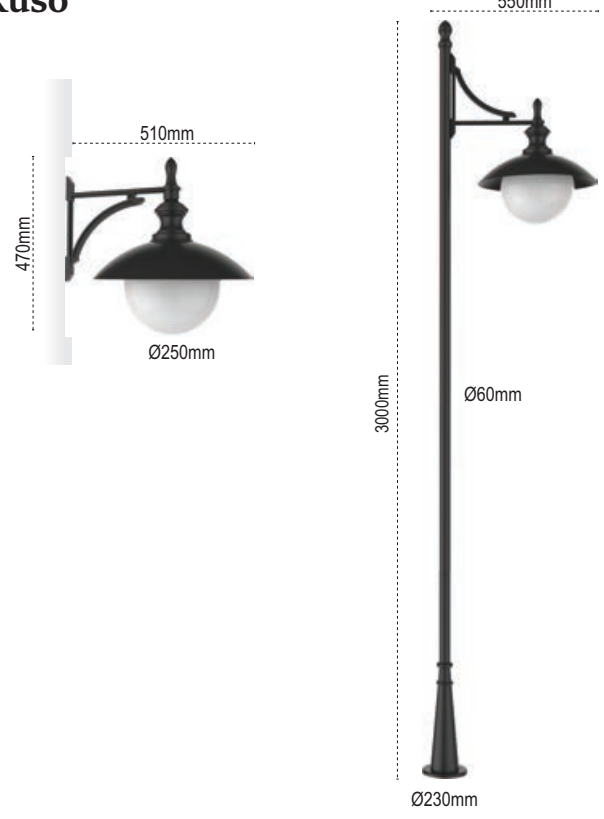

IP 54

kod no	özellikler	koli adedi	fiyat
5714 1200	Ruso Tekli Döküm Dipli Direk E27	1	199,00 \$
5714 1210	Ruso İkili Döküm Dipli Direk E27	1	266,00 \$
5711 1670	Ruso Duvar Aplik E27	1	66,00 \$

## Açelya



IP 54

kod no	özellikler	koli adedi	fiyat
5730 1730	Açelya Fener Aplik E27	10	13,65 \$
5730 1740	Açelya Fener Set Üstü E27	10	13,65 \$

## Karo



IP 54

kod no	özellikler	koli adedi	fiyat
5730 1610	Karo Fener Aplik E27	10	13,65 \$
5730 1620	Karo Fener Set Üstü E27	10	13,65 \$

# Pelsan Takım Park Bahçe Armatürleri

## Uruse

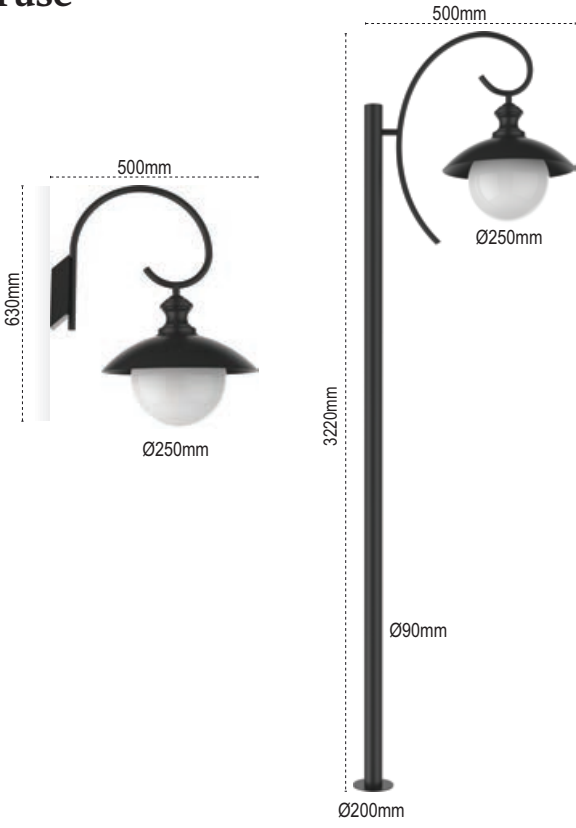

IP 54

kod no	özellikler	koli adedi	fiyat
5714 1420	Uruse Boru Direk E27	1	131,00 \$
5711 1790	Uruse Duvar Aplik E27	1	69,00 \$

## Pisa

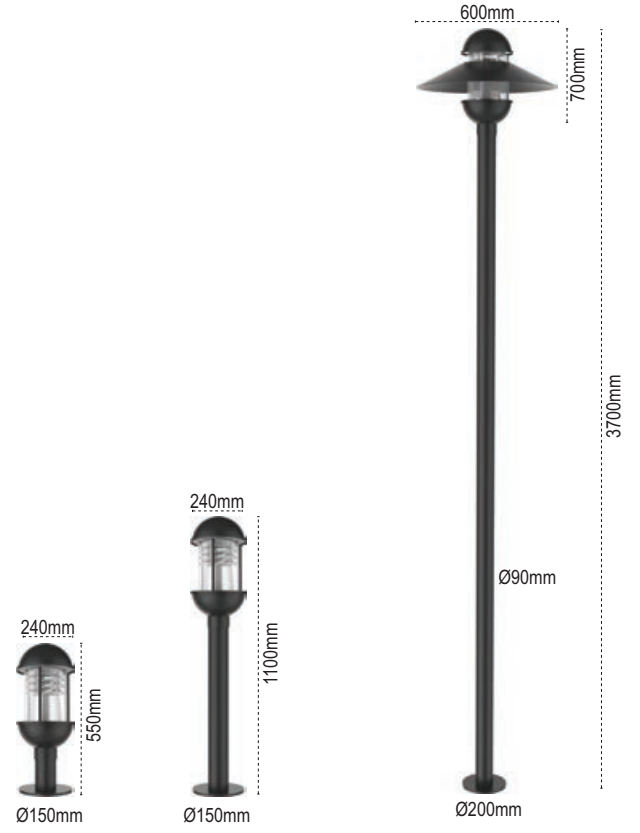

IP 54

kod no	özellikler	koli adedi	fiyat
5715 1300	Pisa Boru Direk Arm. E27	1	203,00 \$
5718 1260	Pisa Boru Çimen Arm. E27	1	116,00 \$
5712 1330	Pisa Set Üstü Arm. E27	1	116,00 \$

## Perge

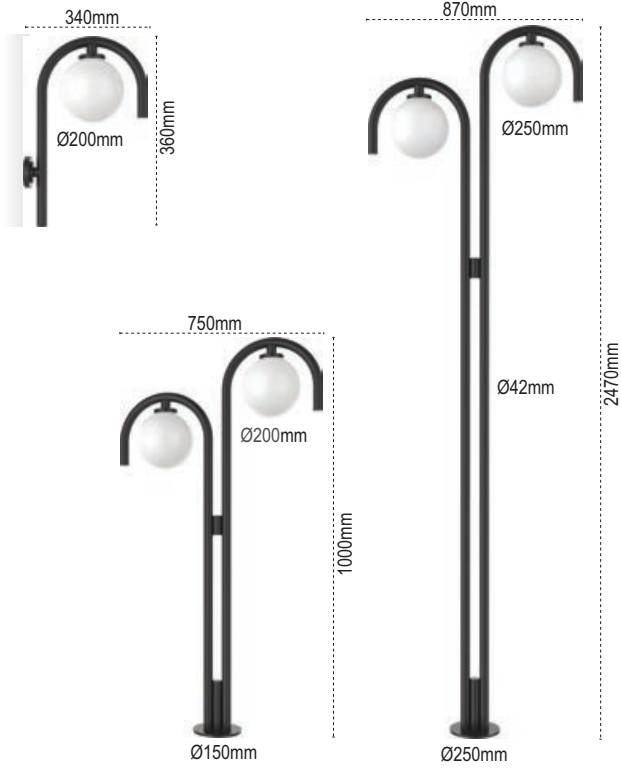

IP 54

kod no	özellikler	koli adedi	fiyat
5716 1110	Perge Direk Arm. E27	1	137,00 \$
5718 1720	Perge Çimen Arm. E27	1	63,00 \$
5711 1180	Perge Aplik E27	1	63,00 \$

## Pedesa



IP 54

kod no	özellikler	koli adedi	fiyat
5715 3060	Pedesa Şeffaf 1 Gloplu Direk E27	1	100,00 \$
5715 1060	Pedesa Şeffaf 2 Gloplu Direk E27	1	168,00 \$
5715 1370	Pedesa Şeffaf 3 Gloplu Direk E27	1	236,00 \$

## Antalya (Alüminyum)

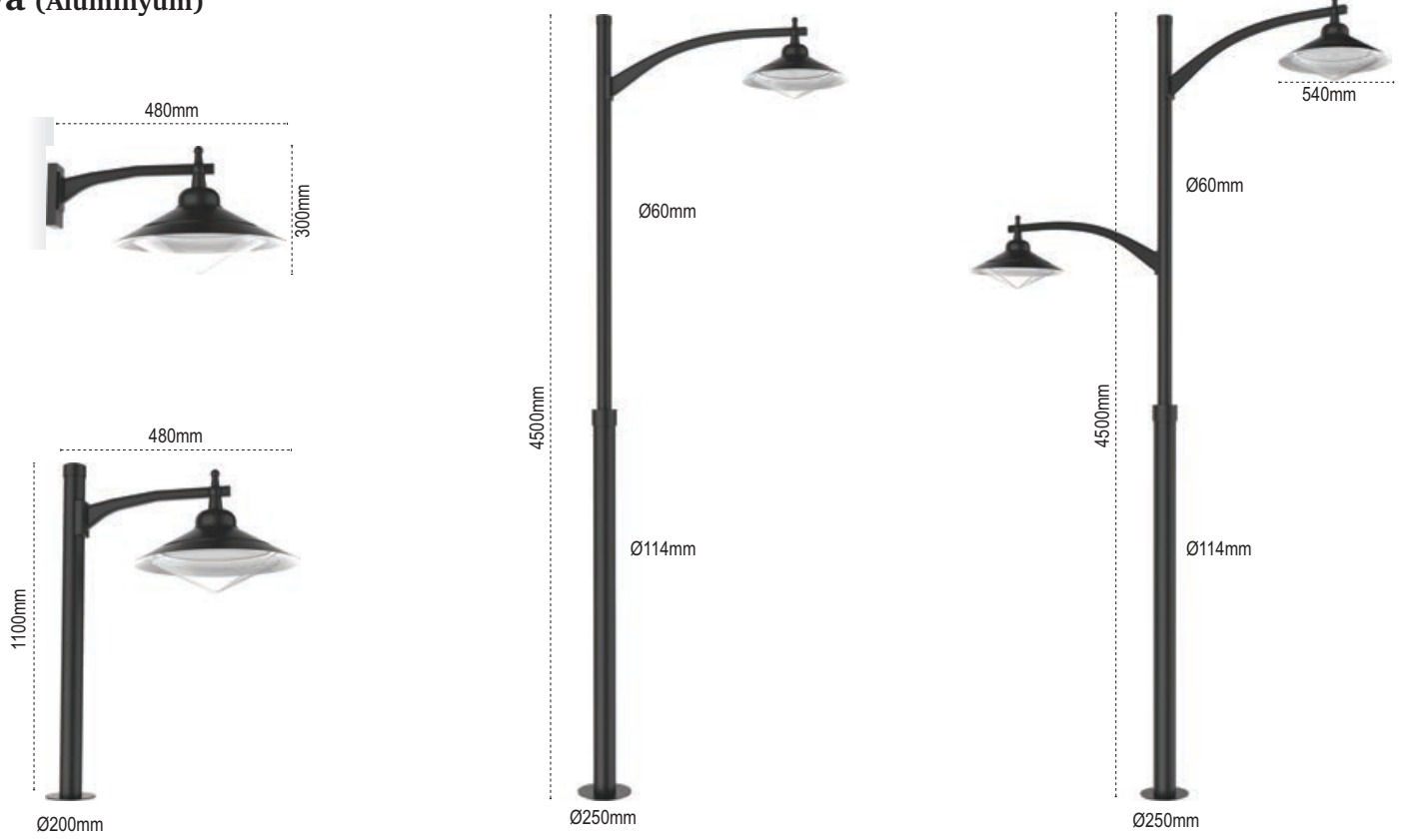

IP 54

kod no	özellikler	koli adedi	fiyat
5715 1380	Antalya 1'li Direk E27	1	192,00 \$
5715 1390	Antalya 2'li Direk E27	1	244,00 \$
5718 1850	Antalya Çimen Arm. E27	1	107,00 \$
5711 2300	Antalya Aplik E27	1	79,00 \$

## Eva

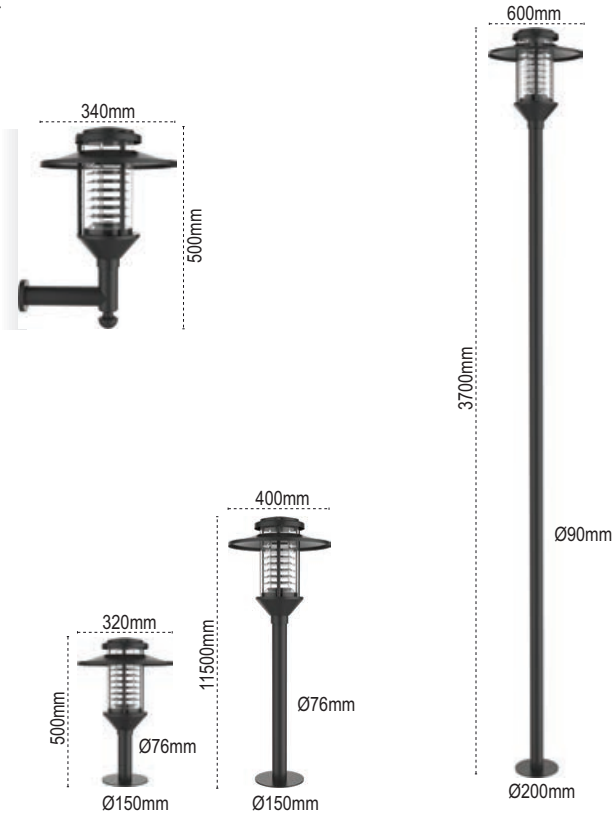

IP 54

kod no	özellikler	koli adedi	fiyat
5715 1290	Eva Boru Direk Arm. E27	1	203,00 \$
5718 1310	Eva Çimen Arm. E27	1	116,00 \$
5712 1340	Eva Set Üstü E27	1	116,00 \$
5711 2510	Eva Aplik E27	1	116,00 \$

## Arta



IP 54

kod no	özellikler	koli adedi	fiyat
5719 1110	Arta Boru Direk Arm. E27	1	203,00 \$
5718 1430	Arta Boru Çimen Arm. E27	1	116,00 \$
5712 1220	Arta Boru Set Üstü E27	1	116,00 \$
5711 2500	Arta Aplik E27	1	116,00 \$

### Milas

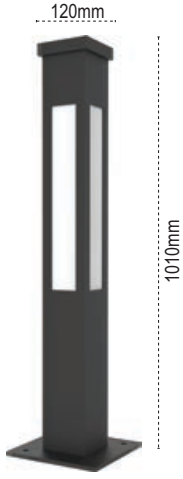

IP 54

kod no	özellikler	koli adedi	fiyat
5718 1710	Milas Çimen Armatürü E27	1	121,00 \$
5718 1730	Milas LED Çimen Armatürü 20W	1	189,00 \$

### Milet - Arta



5615 4721



5718 1430

IP 54

kod no	özellikler	koli adedi	fiyat
5615 4721	Milet LED'li Çimen Armatürü	1	221,00 \$
5718 1430	Arta Boru Çimen Armatürü E27	1	116,00 \$

### Briled

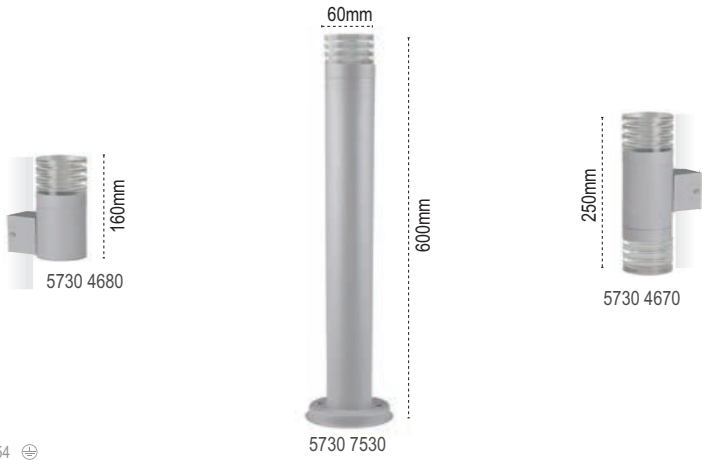

IP 54

kod no	özellikler	koli adedi	fiyat
5730 4680	5W Aplik 4000K	6	30,00 \$
5730 7530	5W Çimen Armatürü 4000K	6	55,00 \$
5730 4670	2x5W Aplik 4000K	6	38,00 \$

### Noa - Fia



IP 54

kod no	özellikler	koli adedi	fiyat
5718 1580	Noa Çimen Armatürü E27	1	79,00 \$
5718 1250	Fia Çimen Armatürü E27	1	116,00 \$

### Pedesa - Perge



IP 54

kod no	özellikler	koli adedi	fiyat
5718 1330	Pedesa Çimen Armatürü E27	1	63,00 \$
5718 1720	Perge Çimen Armatürü E27	1	63,00 \$

### Eva



IP 54

kod no	özellikler	koli adedi	fiyat
5718 1310	Eva Çimen Armatürü E27	1	116,00 \$



## Mezzo



IP 54

kod no	özellikler	koli adedi	fiyat
5616 3310	6W LED 3000K	6	47,30 \$

## Cono

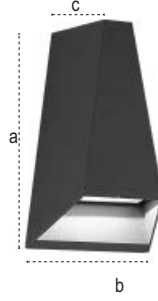

axbxcmm  
5W:170x84x47  
6W:303x101x61

IP 54

kod no	özellikler	koli adedi	fiyat
5616 3330	5W LED 3000K	20	28,40 \$
5615 7851	Extra- 6W LED 3000K	20	41,50 \$

## Verso

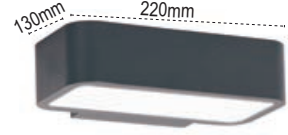

IP 54

kod no	özellikler	koli adedi	fiyat
5616 3320	6W LED 3000K	6	56,80 \$

## Cubo

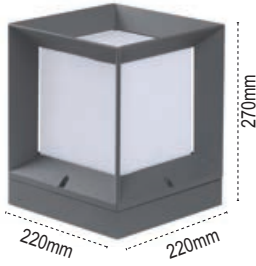

IP 54

kod no	özellikler	koli adedi	fiyat
5712 1410	Cubo E27	6	71,50 \$

## Rayo



IP 54

kod no	özellikler	koli adedi	fiyat
5712 1440	Rayo E27	10	71,50 \$

## Işıldar



IP 44

kod no	özellikler	koli adedi	fiyat
5730 3210	Işıldar E27	6	24,10 \$

## Işıközü Aplik



IP 44

kod no	özellikler	koli adedi	fiyat
5730 3410	Işıközü E27	12	26,30 \$

## Işıközü Sensörlü Aplik

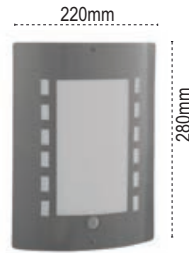

IP 44

kod no	özellikler	koli adedi	fiyat
5730 3420	Işıközü Sensörlü E27	12	37,80 \$

## Briled

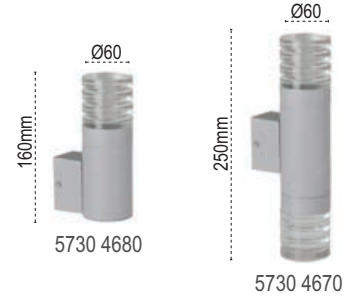

IP 54

kod no	özellikler	koli adedi	fiyat
5730 4670	2x5W Aplik 4000K	6	38,00 \$
5730 4680	5W Aplik 4000K	6	30,00 \$

## Dora LED

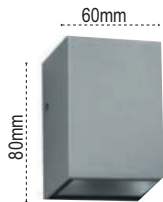

IP 454

kod no	özellikler	koli adedi	fiyat
5732 5110	3W 4000K	24	39,00 \$

## Işılay

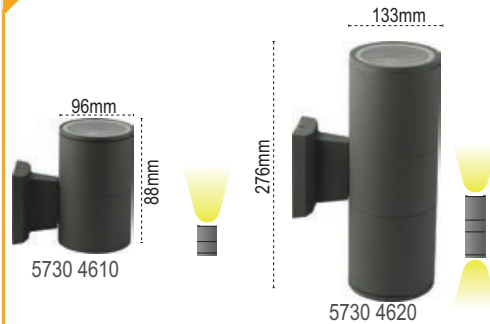

IP 44

kod no	özellikler	koli adedi	fiyat
5730 4610	Işılay1 E27	18	30,50 \$
5730 4620	Işılay2 E27	12	39,00 \$

## Işıl

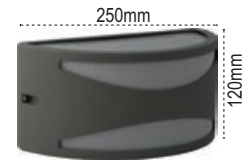

IP 44

kod no	özellikler	koli adedi	fiyat
5730 3310	Işıl E27	12	23,60 \$

# Pelsan Duvar Gömme & Havuz Armatürleri

## Escaled S Duvar Gömme Armatürü



65x65mm

70mm

70mm

60mm

IP 54

kod no	özellikler	koli adedi	fiyat
5730 9060	Escaled S 9 LED'li 4000K	50	9,50 \$

## Escaled Duvar Gömme Armatürü



95x95mm

105mm

105mm

60mm

IP 54

kod no	özellikler	koli adedi	fiyat
5730 9080	Escaled 12 LED'li 4000K	50	12,60 \$

## Dialed Duvar Gömme Armatürü

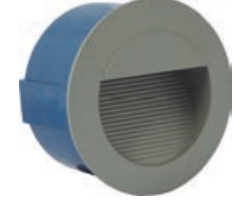

Ø115mm

Ø125

65mm

IP 54

kod no	özellikler	koli adedi	fiyat
5730 9030	Dialed 4000K	24	15,80 \$

## Leraled S Duvar Gömme Armatürü



110mm

45mm

60mm

IP 54

kod no	özellikler	koli adedi	fiyat
5730 9040	Leraled S 14 LED'li 4000K	24	9,50 \$

## Leraled Duvar Gömme Armatürü



159x55mm

170mm

70mm

60mm

IP 54

kod no	özellikler	koli adedi	fiyat
5730 9050	Leraled 18 LED'li 4000K	50	12,60 \$

## Pialed Duvar Gömme Armatürü

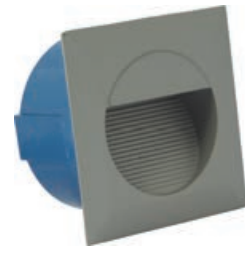

Ø115mm

125mm

65mm

125mm

IP 54

kod no	özellikler	koli adedi	fiyat
5730 9010	Pialed 4000K	24	15,80 \$

## İndiled Duvar Gömme Armatürü



134x81mm

162mm

98mm

66mm

IP44

kod no	özellikler	koli adedi	fiyat
5732 1690	İndiled 4000K	20	12,70 \$

## Doris S.A. Havuz Armatürü 12V



Ø250mm

88mm

1 Adet sürücü ile birlikte 3 havuz armatürü sürülmektedir. Sürücü kendinden senaryoludur.

IP68

kod no	özellikler	koli adedi	fiyat
5412 1520	S.A. Doris 36W 6500K	1	198,00 \$
5412 1530	S.A. Doris 36W RGB	1	225,00 \$
5913 1311	150W Sürücü	1	105,00 \$

## Doris S.Ü. Havuz Armatürü 12V



Ø250mm

50mm

IP68

kod no	özellikler	koli adedi	fiyat
5412 1510	S.Ü. Doris 36W 6500K	1	198,00 \$
5913 1311	150W Sürücü	1	105,00 \$

## LED'li Gömme Havuz Armatürü 24V



Ø360mm

150mm

240mm

IP 68

kod no	özellikler	koli adedi	fiyat
5412 1270	LED'li Gömme 12W RGB	1	102,00 \$
5985 9340	60W 24V Güç Kaynağı	1	45,00 \$
5985 9360	100W 24V Güç Kaynağı	1	84,00 \$

## 12w LED'li Su Altı Armatürü 24V



180mm

136mm

IP 68

kod no	özellikler	koli adedi	fiyat
5412 1360	12W LED'li (İlk Beyaz)	1	104,00 \$
5985 9340	60W 24V Güç Kaynağı	1	45,00 \$
5985 9360	100W 24V Güç Kaynağı	1	84,00 \$

## Grassled Çimen Armatürü



IP 65

kod no	özellikler	koli adedi	fiyat
5732 7010	GrassLED 3W 6500K	20	17,00 \$
5732 7090	GrassLED 3W Yeşil	20	17,00 \$
5732 7020	Saplama aparatı	4	1,00 \$

## LED Yer Gömme 20 15 LED'li

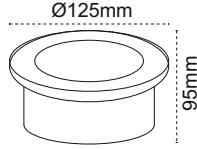

IP65

kod no	özellikler	koli adedi	fiyat
5732 3120	15W LED Yer Gömme 20 4000K	8	179,00 \$

## LED Yer Gömme 15 9 LED'li

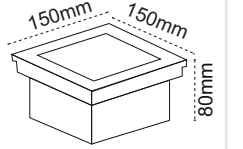

IP65

kod no	özellikler	koli adedi	fiyat
5732 3020	9W LED Yer Gömme 15 4000K	12	109,00 \$

## Midiled 3 LED'li

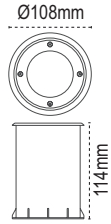

IP65

kod no	özellikler	koli adedi	fiyat
5732 1680	3W Midiled 4000K	6	89,00 \$

## Miniled

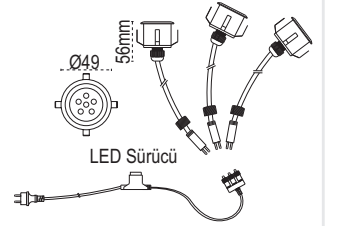

IP65

Sürücü ile Birlikte Üçlü Satılmaktadır.

kod no	özellikler	koli adedi	fiyat
5732 1020	Mini LED Yer Gömme Mavi	4	25,00 \$

## Yer Gömme 11 GU10 Duylu (Lamba Hariç)

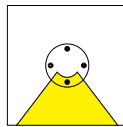

Monoled

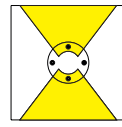

Duoled

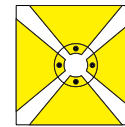

Tetraled

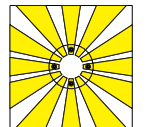

Multiled

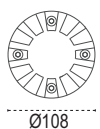
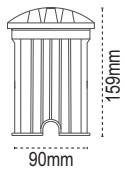

IP 67

kod no	özellikler	koli adedi	fiyat
5732 2510	Monoled Yer Gömme - Tek Yönlü	30	25,60 \$
5732 2520	Duoled Yer Gömme - Çift Yönlü	30	25,60 \$
5732 2530	Tetraled Yer Gömme - Dört Yönlü	30	25,60 \$
5732 2540	Multiled Yer Gömme - Çok Yönlü	30	25,60 \$



# 2 Kere Kazan

Hem Alırken Hem Kullanırken



• Diğer Lambalara Göre 15 Kat Daha Çevreci

• %90 'a Varan Enerji Tasarrufu

## LED Glop Lambalar

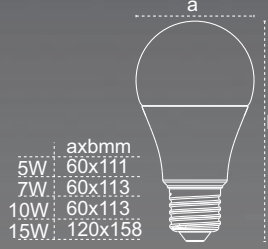

kod no	özellikler	koli adedi	fiyat
5981 2660	5W 2700K E27	100	2,10 \$
5981 2650	5W 6400K E27	100	2,10 \$
5981 2680	7W 2700K E27	100	2,30 \$
5981 2690	7W 6400K E27	100	2,30 \$
5981 2740	10W 2700K E27	100	2,65 \$
5981 2790	10W 6400K E27	100	2,65 \$
5981 2850	15W 6500K E27	20	10,20 \$

### Buji LED Lamba (E14)

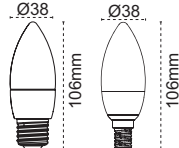

kod no	özellikler	koli adedi	fiyat
5981 2530	4W 2700K E14	100	2,10 \$

### Buji LED Lamba (E27)

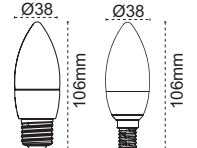

kod no	özellikler	koli adedi	fiyat
5981 2540	4W 6500K E27	100	2,10 \$

### Dim Edilebilir LED Lamba

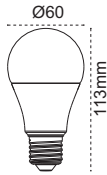

kod no	özellikler	koli adedi	fiyat
5981 4010	10W 6500K E27	50	8,70 \$

### Şarj Edilebilir LED Lamba

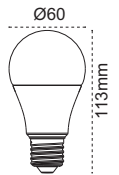

kod no	özellikler	koli adedi	fiyat
5981 4050	10W 6500K E27	50	9,00 \$

### Kapsul Lamba (G4)



kod no	özellikler	koli adedi	fiyat
5983 1410	3W Kapsül 4000K G4	100	2,80 \$

### Kapsul Lamba (G9)

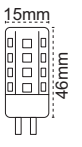

kod no	özellikler	koli adedi	fiyat
5983 1420	3W Kapsül 4000K G9	100	2,80 \$



### Buji Filament Lamba

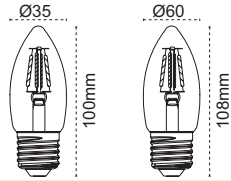

kod no	özellikler	koli adedi	fiyat
5982 2040	4W Buji Lamba E27 3000K	100	3,40 \$
5982 2060	4W Buji Lamba E27 6500K	100	3,40 \$

### Kıvrık Buji Filament Lamba

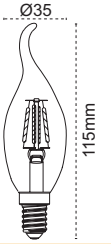

kod no	özellikler	koli adedi	fiyat
5982 2030	4W Buji Kıvrık Lamba E14 3000K	100	3,40 \$

### Filament Lamba (Ø60)

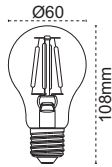

kod no	özellikler	koli adedi	fiyat
5982 2050	4W Filament Lamba E27 3000K	100	3,40 \$

### Filament Lamba (Ø95)

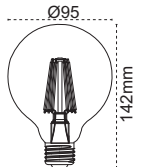

kod no	özellikler	koli adedi	fiyat
5982 2080	6W Filament E27 3000K	20	7,50 \$

### Filament Lamba (Ø125)

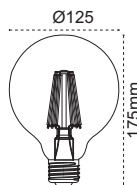

kod no	özellikler	koli adedi	fiyat
5982 2090	6W Filament E27 3000K	20	9,00 \$

### Filament Lamba (Ø64)

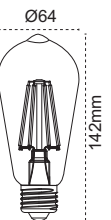

kod no	özellikler	koli adedi	fiyat
5982 2070	6W Filament E27 3000K	40	6,25 \$

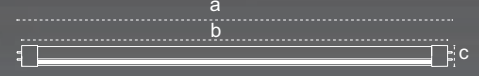
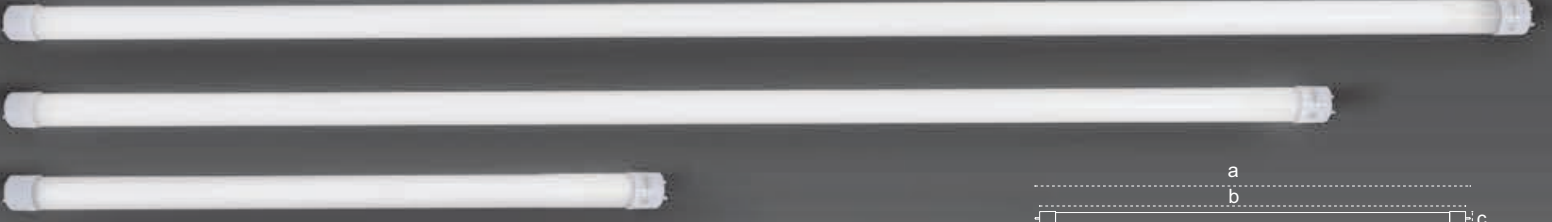

## Değiştirmeden Dönüştürün

## LED Tube Lambalar

kod no	özellikler	koli adedi	fiyat
5985 5180	9W 4000K LED Tube G13	25	4,45 \$
5985 5190	9W 6500K LED Tube G13	25	4,45 \$
5985 5220	18W 4000K LED Tube G13	25	5,50 \$
5985 5210	18W 6500K LED TUBE G13	25	5,50 \$
5985 5260	24W 4000K LED Tube G13	25	8,50 \$
5985 5250	24W 6500K LED Tube G13	25	8,50 \$
5913 1460	9-18W LED Tube Konvertör Kit	100	52,60 \$

### 30w LED Lamba

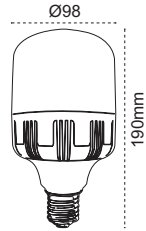

kod no	özellikler	koli adedi	fiyat
5981 2860	30W 6500K E27	20	14,90 \$

### 40w LED Lamba

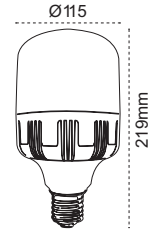

kod no	özellikler	koli adedi	fiyat
5981 2870	40W 6500K E27	20	18,70 \$

### 24w LEDLamba

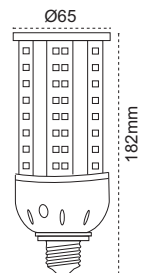

kod no	özellikler	koli adedi	fiyat
5981 2840	24W 6500K E27	25	46,90 \$

### Dairesel LED Lamba

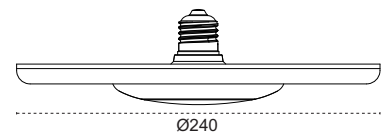

kod no	özellikler	koli adedi	fiyat
5981 3010	18W Dairesel Ø24 E27 6500K	20	11,00 \$

### Sodyum Lambalar



axbmm	
50W:	160x38
70W:	160x38
100W:	204x46
150W:	204x46

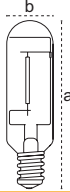

kod no	özellikler	koli adedi	fiyat
5984 5010	50 2000K E27	25	5,40 \$
5984 5020	70W 2000K E27	25	5,40 \$
5984 5030	100W 2000K E40	24	6,20 \$
5984 5040	150W 2000K E40	24	6,60 \$

### Sodyum Lambalar



axbmm	
150W:	244x46
250W:	270x46
400W:	360x66,5

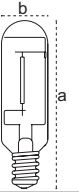

kod no	özellikler	koli adedi	fiyat
5984 5050	250W 2000K E40	24	8,50 \$
5984 5060	400W 2000K E40	24	9,40 \$
5984 5070	1000W 2000K E40	20	47,25 \$

### Metal Lambalar



axbmm	
150W:	204x46
250W:	247x46

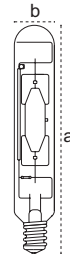

kod no	özellikler	koli adedi	fiyat
5984 6560	150W 4200K E40	24	9,40 \$
5984 6070	250W 4200K E40	24	9,40 \$

### Metal Lambalar



axbmm	
400W:	267x46
1000W:	367x66

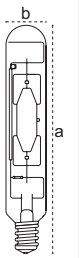

kod no	özellikler	koli adedi	fiyat
5984 6080	400W 4200K E40	24	9,40 \$
5984 6020	1000W 4200K E40	20	47,25 \$

### Metal Lambalar



axbmm	
70W G12:	89x22,5
150W G12:	99x22,5
70W Rx7s:	116x22,5
150W Rx7s:	137x23,5

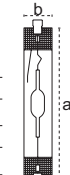

kod no	özellikler	koli adedi	fiyat
5981 6510	70W 4200K G12	100	10,00 \$
5981 6520	150W 4200K G12	100	11,50 \$
5981 6540	70W 3000K G12	100	10,50 \$
5981 6550	150W 3000K G12	100	11,50 \$
5981 6010	70W 4200K Rx7s	100	9,00 \$
5981 6110	150W 4200K Rx7s	100	9,00 \$

### Par Lamba

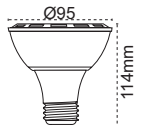

kod no	özellikler	koli adedi	fiyat
5981 2710	12X1W PAR30 Lamba 4000K E27	20	10,40 \$
5981 2720	12X1W PAR38 Lamba 6500K E27	20	10,40 \$
5981 2730	11X1W PAR30 Lamba 4000K E27	20	6,90 \$
5981 2210	7X1W PAR30 Lamba 6500K E27	20	6,45 \$

### Power LED Lamba & Cob LED Lamba

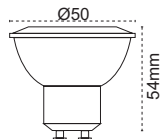

kod no	özellikler	koli adedi	fiyat
5981 1120	3X1W 6500K GU10	100	3,45 \$
5981 2920	5W COB 3000K GU10	200	4,20 \$

### Power LED Lamba

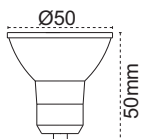

kod no	özellikler	koli adedi	fiyat
5981 1170	3X1W 4000K GU10	200	3,45 \$
5981 1320	3X1W 3000K GU5,3	200	2,50 \$
5981 1310	3X1W 6500K GU5,3	200	2,50 \$

## Ömür Boyunca Aynı Işık Çıktısı

- 30000 saat ömür
- Etkin ısı tekniği sağlayan özel LED kilidi
- 3M Bant
- Her 3 modülde bir kesilebilme
- 12V DC ile çalışır



### İç Mekan LED Şerit Tek Çip IP20

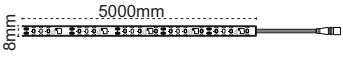

1,24 \$/m

12V DC IP 20

kod no	özellikler	koli adedi	fiyat
5985 3010	IP20 SMD LED Beyaz 5 metre	1	6,00 \$
5985 3020	IP20 SMD LED Sarı 5 metre	1	6,00 \$
5985 3030	IP20 SMD LED Kırmızı 5 metre	1	6,00 \$
5985 3040	IP20 SMD LED Yeşil 5 metre	1	6,00 \$
5985 3050	IP20 SMD LED Mavi 5 metre	1	6,00 \$
5985 3060	IP20 SMD LED Ilık Beyaz 5 metre	1	6,00 \$
5985 3080	IP20 SMD LED Amber 5 metre	1	6,20 \$

### Dış Mekan LED Şerit Tek Çip IP65

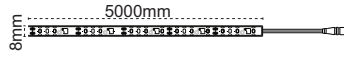

1,62 \$/m

12V DC IP 55

kod no	özellikler	koli adedi	fiyat
5985 2310	IP65 SMD LED Beyaz 5 metre	1	8,00 \$
5985 2320	IP65 SMD LED Sarı 5 metre	1	8,00 \$
5985 2330	IP65 SMD LED Kırmızı 5 metre	1	8,00 \$
5985 2340	IP65 SMD LED Yeşil 5 metre	1	8,00 \$
5985 2350	IP65 SMD LED Mavi 5 metre	1	8,00 \$
5985 2360	IP65 SMD LED Ilık Beyaz 5 metre	1	8,00 \$
5985 2380	IP65 SMD LED Amber 5 metre	1	8,00 \$

### İç Mekan LED Şerit Üç Çip IP20

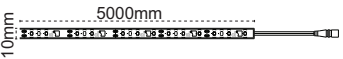

2,26 \$/m

12V DC IP 20

kod no	özellikler	koli adedi	fiyat
5985 3210	IP20 SMD LED Beyaz 5 metre	1	11,30 \$
5985 3220	IP20 SMD LED Sarı 5 metre	1	11,30 \$
5985 3230	IP20 SMD LED Kırmızı 5 metre	1	11,30 \$
5985 3240	IP20 SMD LED Yeşil 5 metre	1	11,30 \$
5985 3250	IP20 SMD LED Mavi 5 metre	1	11,30 \$
5985 3260	IP20 SMD LED Ilık Beyaz 5 metre	1	11,30 \$
5985 3270	IP20 SMD LED RGB 5 metre	1	15,10 \$

### Dış Mekan LED Şerit Üç Çip IP65

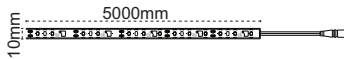

2,82 \$/m

12V DC IP 55

kod no	özellikler	koli adedi	fiyat
5985 2510	IP65 SMD LED Beyaz 5 metre	1	14,10 \$
5985 2520	IP65 SMD LED Sarı 5 metre	1	14,10 \$
5985 2530	IP65 SMD LED Kırmızı 5 metre	1	14,10 \$
5985 2540	IP65 SMD LED Yeşil 5 metre	1	14,10 \$
5985 2550	IP65 SMD LED Mavi 5 metre	1	14,10 \$
5985 2560	IP65 SMD LED Ilık Beyaz 5 metre	1	14,10 \$
5985 2580	IP65 SMD LED Amber 5 metre	1	14,10 \$
5985 2570	IP65 SMD LED RGB 5 metre	1	18,85 \$

### 12V IP20 Sabit Gerilim Sürücüler



IP 20

kod no	özellikler	Tek Çip	3 Çip	koli adedi	fiyat
5918 2410	30W 12V 2,5A	max 5m	max 2,5m	1	5,75 \$
5918 2420	60W 12V 5A	max 12m	max 5m	1	8,50 \$
5918 2430	100W 12V 8,5A	max 20m	max 8m	1	9,45 \$
5918 2440	150W 12V 12,5A	max 30m	max 12m	1	14,15 \$
5918 2450	200W 12V 17A	max 40m	max 15m	1	15,10 \$
5918 2460	360W 12V 30A	max 50m	max 30m	1	20,75 \$

### 12V IP67 Sabit Gerilim Sürücüler



IP 67

kod no	özellikler	Tek Çip	3 Çip	koli adedi	fiyat
5918 2470	60W 12V 5A	max 12m	max 5m	1	18,85 \$
5918 2480	100W 12V 8,5A	max 20m	max 8m	1	33,95 \$



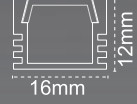
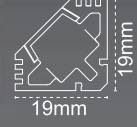

## Her Mekana Özel Çözüm!

- Sıva altı, sıva üstü ve köşe seçeneği
- IP67 dış mekan, IP20 iç mekan uygulaması
- 30 / 50 / 100 / 200 cm boy opsiyonu
- 2700 / 3000 / 4000 / 6500 K Kırmızı / Yeşil / Mavi / Amber
- 60 / 120 adet LED opsiyonu

### İç Mekan LED Bar IP20



kod no	özellikler	koli adedi	fiyat
5618 1114	LED Bar S.Ü. 19W 60 LED/m 100 cm	1	27,30\$
5618 3114	LED Bar Köşe 19W 60 LED/m 100 cm	1	27,30 \$
5618 2114	LED Bar S.A. 19W 60 LED/m 100 cm	1	27,30 \$
5618 1314	LED Bar S.Ü. 29W 120 LED/m 100 cm	1	33,90 \$
5618 3314	LED Bar Köşe 29W 120 LED/m 100 cm	1	33,90 \$
5618 2314	LED Bar S.A. 29W 120 LED/m 100 cm	1	33,90 \$

### Dış Mekan LED Bar IP67



kod no	özellikler	koli adedi	fiyat
5618 1124	LED Bar S.Ü. 19W 60 LED/m 100 cm	1	35,00 \$
5618 3124	LED Bar Köşe 19W 60 LED/m 100 cm	1	35,00 \$
5618 2124	LED Bar S.A. 19W 60 LED/m 100 cm	1	35,00 \$
5618 1324	LED Bar S.Ü. 29W 120 LED/m 100 cm	1	42,60 \$
5618 3324	LED Bar Köşe 29W 120 LED/m 100 cm	1	42,60 \$
5618 2324	LED Bar S.A. 29W 120 LED/m 100 cm	1	42,60 \$



### İç Mekan LED Bar Sürücüleri



kod no	özellikler	60 LED/m	120 LED/m	koli adedi	fiyat
5918 2611	60W 24V 2,5A	max 3m	max 2m	1	11,40 \$
5918 2620	120W 24V 5A	max 6m	max 4m	1	26,50 \$
5918 2630	200W 24V 8,3A	max 9m	max 6m	1	27,40 \$
5918 2640	360W 24V 15A	max 16m	max 12m	1	28,40 \$

### Dış Mekan LED Bar Sürücüleri



kod no	özellikler	60 LED/m	120 LED/m	koli adedi	fiyat
5918 2650	150W 24V 6,25A	max 6m	max 4m	1	47,30 \$
5918 2660	200W 24V 8,3A	max 9m	max 6m	1	56,80 \$

### Difüzör Çeşitleri

kod no	özellikler	koli adedi	fiyat
4301 662	Buzlu Bombeli (Sıva Üstü LED Bar)	100 cm Cam	2,50 \$
4301 652	Şeffaf Bombeli (Sıva Üstü LED Bar)	100 cm Cam	2,50 \$
4301 642	Opal Bombeli (Sıva Üstü LED Bar)	100 cm Cam	2,50 \$
4301 692	Buzlu Düz (Sıva Altı / Köşe LED Bar)	100 cm Cam	2,50 \$
4301 682	Şeffaf Düz (Sıva Altı / Köşe LED Bar)	100 cm Cam	2,50 \$
4301 672	Opal Düz (Sıva Altı / Köşe LED Bar)	100 cm Cam	2,50 \$

**30W IP20**  
Sabit Gerilim Sürücü (12V)

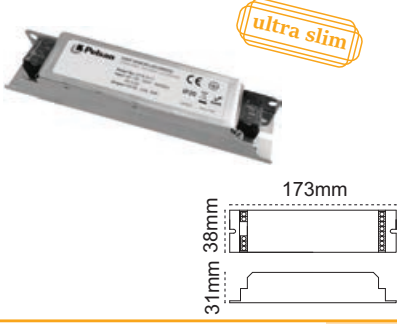

kod no	özellikler	koli adedi	fiyat
5918 2411	30W 12V 2,5A	100	4,75 \$

**60W IP20**  
Sabit Gerilim Sürücü (12V)

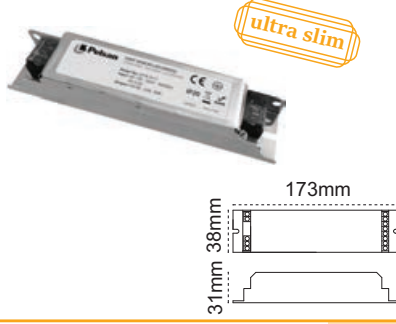

kod no	özellikler	koli adedi	fiyat
5918 2421	60W 12V 5A	36	7,15 \$

**100W IP20**  
Sabit Gerilim Sürücü (12V)

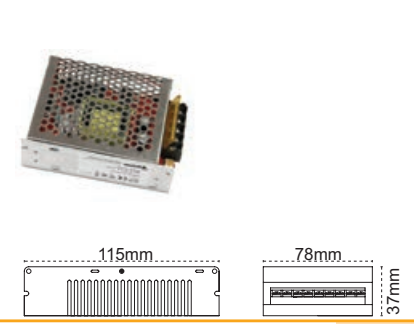

kod no	özellikler	koli adedi	fiyat
5918 2430	100W 12V 8,5A	36	9,45 \$

**150W IP20**  
Sabit Gerilim Sürücü (12V)

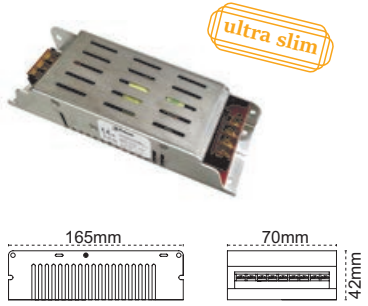

kod no	özellikler	koli adedi	fiyat
5918 2441	150W 12V 12,5A	28	12,45 \$

**200W IP20**  
Sabit Gerilim Sürücü (12V)

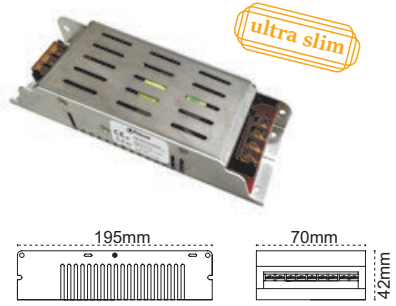

kod no	özellikler	koli adedi	fiyat
5918 2451	200W 12V 17A	24	15,10 \$

**200W IP20**  
Sabit Gerilim Sürücü (12V)

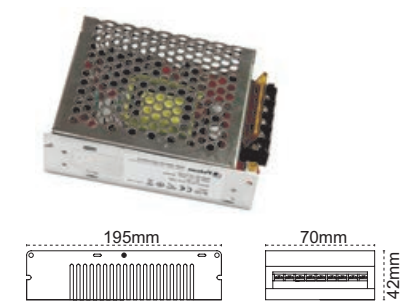

kod no	özellikler	koli adedi	fiyat
5918 2450	200W 12V 17A	24	15,10 \$

**360W IP20**  
Sabit Gerilim Sürücü (12V)

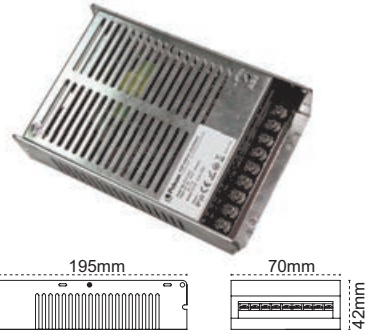

kod no	özellikler	koli adedi	fiyat
5918 2460	360W 12V 30A	21	20,75 \$

**60W IP67**  
Sabit Gerilim Sürücü (12V)



kod no	özellikler	koli adedi	fiyat
5918 2470	60W 12V 5A	700	18,85 \$

**100W IP67**  
Sabit Gerilim Sürücü (12V)

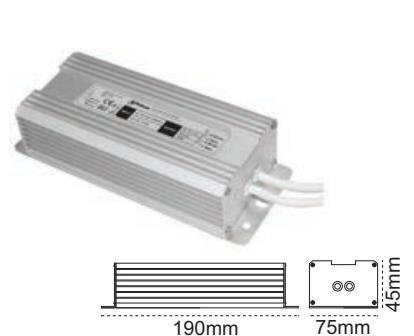

kod no	özellikler	koli adedi	fiyat
5918 2480	100W 12V 8,5A	72	33,95 \$

**24V IP20**  
Sabit Gerilim Sürücü

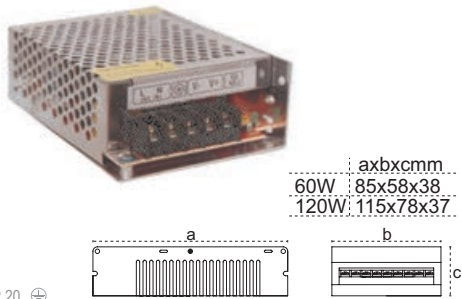

kod no	özellikler	koli adedi	fiyat
5918 2611	60W 24V 2,5A	100	11,40 \$
5918 2620	120W 24V 5A	32	26,50 \$

**24V IP20**  
Sabit Gerilim Sürücü

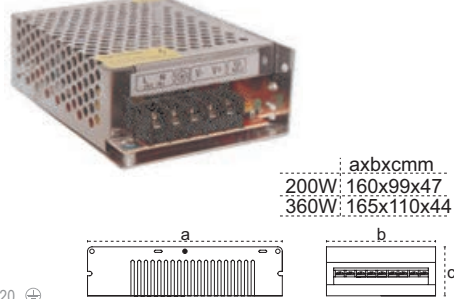

kod no	özellikler	koli adedi	fiyat
5918 2630	200W 24V 8,3A	36	27,40 \$
5918 2640	360W 24V 15A	32	28,40 \$

**24V IP67**  
Sabit Gerilim Sürücü

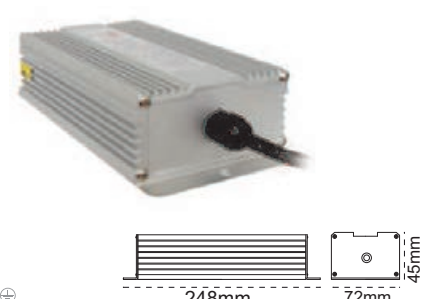

kod no	özellikler	koli adedi	fiyat
5918 2650	150W 24V 6,25A	10	47,30 \$
5918 2660	200W 24V 8,3A	10	56,80 \$

## Y.B Metal Halide



axbxcmm	
35W	155x42x33
70W	116x64x54
150W	122x78x66
250W	135x93x79
400W	135x93x79
1000W	197x126x138
2000W	225x126x138

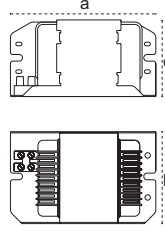

IP 40

kod no	özellikler	koli adedi	fiyat
5912 1181	Metal Halide 35W	24	8,15 \$
5912 1211	Metal Halide 70W	16	9,05 \$
5912 1221	Metal Halide 150W	8	13,30 \$
5912 1231	Metal Halide 250W	4	20,70 \$
5912 1241	Metal Halide 400W	4	22,90 \$
5912 1251	Metal Halide 1000W	2	59,10 \$
5912 1261	Metal Halide 2000W (380V)	1	92,30 \$

## Y.B Sodyum Buharlı



axbxcxdmm	
50W	116x64x54
70W	116x64x54
100W	116x64x54
150W	122x78x66
250W	135x93x72
400W	156x93x69
600W	178x126x138
1000W	197x126x138

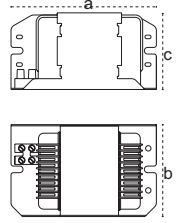

IP 40

kod no	özellikler	koli adedi	fiyat
5912 1071	Sodyum Buharlı 50W	16	8,15 \$
5912 1101	Sodyum Buharlı 70W	16	9,05 \$
5912 1081	Sodyum Buharlı 100W	16	9,65 \$
5912 1111	Sodyum Buharlı 150W	4	13,30 \$
5912 1121	Sodyum Buharlı 250W	4	20,70 \$
5912 1131	Sodyum Buharlı 400W	2	26,70 \$
5912 1161	Sodyum Buharlı 600W	2	46,20 \$
5912 1141	Sodyum Buharlı 1000W	2	59,10 \$

## Metal Kitler



axbxcmm	
35W	185x115x88
70W	150x64x54
150W	166x77x65
250W	205x93x79
400W	232x93x79
1000W	246x126x138

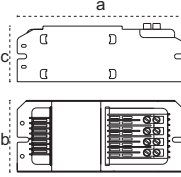

IP 20

kod no	özellikler	koli adedi	fiyat
5511 2481	Metal Kit 35W Balast + ignitör	4	15,90 \$
5511 2431	Metal Kit 70W Balast + ignitör	4	16,70 \$
5511 2441	Metal Kit 150W Balast + ignitör	4	24,40 \$
5511 2451	Metal Kit 250W Balast + ignitör	4	28,80 \$
5511 2461	Metal Kit 400W Balast + ignitör	4	30,70 \$
5511 2981	Metal Kit 1000W Balast + ignitör	1	84,90 \$

## Sera Kitler



axbxcmm	
250W	205x93x79
400W	232x93x79
600W	246x126x138
1000W	246x126x138

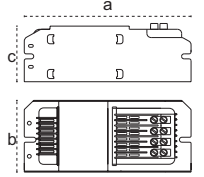

IP 20

kod no	özellikler	koli adedi	fiyat
5511 2391	Sera 400W SB Balast Kiti	4	36,10 \$
5511 2401	Sera 600W SB Balast Kiti	1	59,65 \$

## Silver Floresant Balast

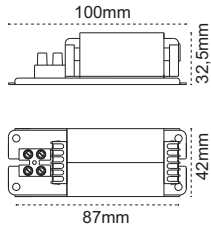

IP 40

kod no	özellikler	koli adedi	fiyat
5911 3001	15W TLD	36	2,80 \$
5911 3061	20W TLD	36	2,80 \$
5911 3091	32W TLD	36	2,80 \$
5911 3071	36-40W TLD	36	2,80 \$

## Elektronik Balast

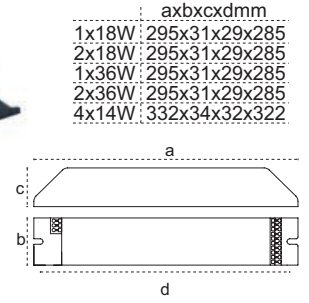

IP 40

axbxcxdmm			
1x18W	295x31x29x285	koli adedi	fiyat
2x18W	295x31x29x285	10	10,60 \$
1x36W	295x31x29x285	10	11,60 \$
2x36W	295x31x29x285	10	10,60 \$
4x14W	332x34x32x322	10	11,60 \$
5917 1620	4X14W TLD	10	13,70 \$

## Konvertör Kitler

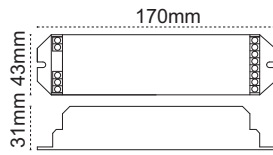

IP 20

kod no	özellikler	koli adedi	fiyat
5913 1090	18-36W Mekanik Balast için 1 Saat	10	37,80 \$
5913 1120	18-36W Mekanik Balast için 3 Saat	10	37,80 \$
5913 1580	18-36W Elektronik Balast için 1 Saat	10	42,00 \$
5913 1590	18-36W Elektronik Balast için 3 Saat	10	42,00 \$

## LED Konvertör kitler

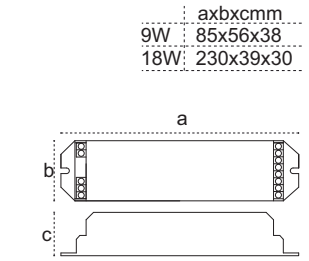

IP 20

axbxcmm			
9W	85x56x38	koli adedi	fiyat
18W	230x39x30	100	52,60 \$
5913 1470	12-110V LED Model Konvertör Kit	100	52,60 \$
5913 1480	9-60V LED Model Konvertör Kit	100	52,60 \$
5913 1460	9-18W LED Tube Konvertör Kit	100	52,60 \$

### Zaman Ayarlı Ateşleyici

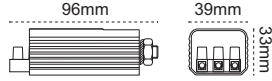

IP 20

kod no	özellikler	koli adedi	fiyat
3140 131	Zaman ayarlı 35-150W	10	5,80 \$
3140 132	Zaman ayarlı 50-400W	10	5,80 \$

### Uzaktan Ateşleyici

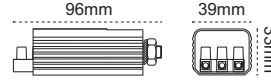

IP 20

kod no	özellikler	koli adedi	fiyat
3140 107	35-150W (25 m kadar)	10	5,00 \$
3140 108	50-400W (25 m kadar)	10	5,00 \$
3140 141	600-1000W (25 m kadar)	10	14,80 \$

### Starter

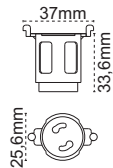

IP 20

kod no	özellikler	koli adedi	fiyat
3120 106	4-65W	25	0,19 \$
3120 107	Seri 4-22W	25	0,22 \$

### Asma Duy

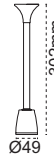

IP 20

kod no	özellikler	koli adedi	fiyat
3170 131	Pelsan Asma Duy E27	50	0,80 \$
3170 133	Porselen Tij Takımı E27	50	0,80 \$

### Lamba Duyları

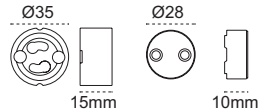

IP 40

kod no	özellikler	koli adedi	fiyat
3110 120	GU10 Porselen Duy	100	0,55 \$
3110 201	GX5.3 Porselen Duy	100	0,25 \$
3110 122	G12 Porselen Duy	100	1,90 \$

### Porselen Duylar

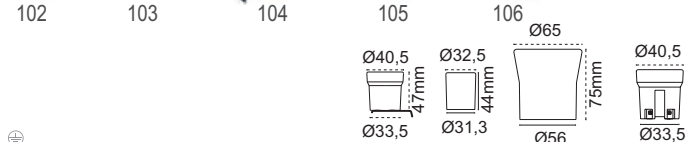

IP 40

kod no	özellikler	koli adedi	fiyat
3110 102	E14 Porselen Duy	480	0,23 \$
3110 112	E14 Lamalı Porselen Duy	400	0,26 \$
3110 103	E27 Porselen Duy	400	0,23 \$
3110 113	E27 Lamalı Porselen Duy	400	0,26 \$
3110 115	E40 Porselen Duy	100	2,90 \$

### IP20 Sabit Akım LED Sürücüler

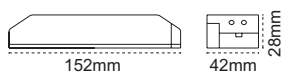

IP 20

kod no	özellikler	koli adedi	fiyat
5918 1710	400 mA 25-63 Vdc Çıkış Gerilimi	100	21,80 \$
5918 1610	600 mA 33-68 Vdc Çıkış Gerilimi	100	29,60 \$

### IP20 Sabit Akım LED Sürücüler

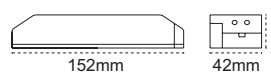

IP 20

kod no	özellikler	koli adedi	fiyat
5918 1720	600 mA 16-42 Vdc Çıkış Gerilimi	100	22,60 \$
5918 1730	700 mA 11-25 Vdc Çıkış Gerilimi	100	13,25 \$

## Opak Pano

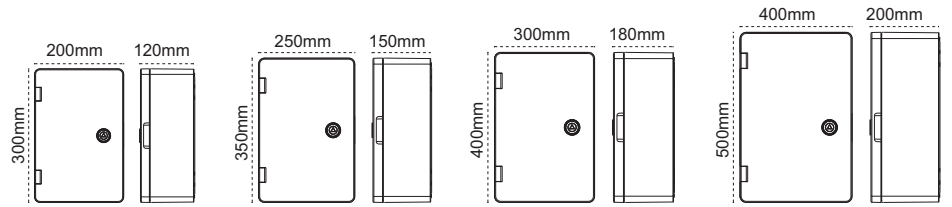

IP 40

kod no	özellikler	koli adedi	fiyat
5921 1711	ABS Taban Saclı 200X300X120 mm Opak Pano	1	31,95 ₺
5921 1721	ABS Taban Saclı 250X350X150 mm Opak Pano	1	40,95 ₺
5921 1731	ABS Taban Saclı 300X400X180 mm Opak Pano	1	53,55 ₺
5921 1741	ABS Taban Saclı 400X500X210mm Opak Pano	1	89,55 ₺

## Şeffaf Pano

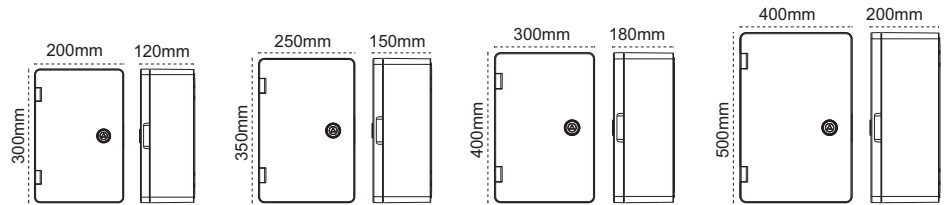

IP 40

kod no	özellikler	koli adedi	fiyat
5921 1751	ABS Taban Saclı 200X300X120 mm Şeffaf Pano	1	35,50 ₺
5921 1761	ABS Taban Saclı 250X350X150 mm Şeffaf Pano	1	45,40 ₺
5921 1771	ABS Taban Saclı 300X400X180 mm Şeffaf Pano	1	58,50 ₺
5921 1781	ABS Taban Saclı 400x500x210 mm Şeffaf Pano	1	99,00 ₺

**Keira Antibakteriyel Anahtar ve Priz Serisi**



Antibakteriyel K13

Kod No	Cinsi	Koli Ad.	Keira Antibakteriyel Seri
<b>Anahtar Grubu</b>			
5963 1001	Anahtar	120	<b>5,30 ₺</b>
5963 1002	Light	120	<b>5,50 ₺</b>
5963 1003	Kapı otomatiği	120	<b>5,50 ₺</b>
5963 1004	Zil anahtarı	120	<b>5,50 ₺</b>
5963 1005	Komitatör	120	<b>6,40 ₺</b>
5963 1006	Vavien	120	<b>6,40 ₺</b>
5963 1007	Permitatör	120	<b>8,00 ₺</b>
5963 1008	Komitatör vavien	120	<b>8,75 ₺</b>
5963 1009	Jaluzi anahtarı	120	<b>10,25 ₺</b>
5963 1010	Şofben anahtarı	120	<b>16,60 ₺</b>
5963 1011	3'lü anahtar	120	<b>14,10 ₺</b>
<b>Priz Grubu</b>			
5963 1014	Priz	120	<b>5,30 ₺</b>
5963 1015	Topraklı priz	120	<b>6,25 ₺</b>
5963 1016	Çocuk korumalı topraklı priz	120	<b>8,50 ₺</b>
5963 1017	UPS topraklı priz	120	<b>8,00 ₺</b>
5963 1018	UPS çocuk korumalı topraklı priz	120	<b>8,40 ₺</b>
5963 1019	Kapaklı topraklı priz	120	<b>7,20 ₺</b>
5963 1020	Çocuk korumalı kapaklı topraklı priz	120	<b>9,70 ₺</b>
5963 1021	UPS kapaklı topraklı priz	120	<b>13,00 ₺</b>
5963 1023	ikili priz	100	<b>7,00 ₺</b>
5963 1024	ikili topraklı priz	70	<b>7,60 ₺</b>
<b>TV/Radyo Grubu</b>			
5963 1030	TV priz geçişli	120	<b>9,60 ₺</b>
5963 1031	TV priz sonlu	120	<b>9,60 ₺</b>
5963 1032	TV priz dirençsiz	120	<b>9,60 ₺</b>
5963 1033	Uydu prizi F konnektörlü geçişli	120	<b>14,30 ₺</b>
5963 1034	Uydu prizi F konnektörlü sonlu	120	<b>14,30 ₺</b>
5963 1035	TV - Radyo priz geçişli	120	<b>26,40 ₺</b>
5963 1036	TV - Radyo priz sonlu	120	<b>26,40 ₺</b>
5963 1037	TV - Sat priz geçişli	120	<b>40,60 ₺</b>
5963 1038	TV - Sat priz sonlu	120	<b>40,60 ₺</b>

Kod No	Cinsi	Koli Ad.	Keira Antibakteriyel Seri
<b>İletişim Grubu</b>			
5963 1040	Telefon prizi	120	<b>5,30 ₺</b>
5963 1041	Numeris telefon prizi (RJ11)	120	<b>6,90 ₺</b>
5963 1042	«kili numeris (RJ11)	120	<b>10,80 ₺</b>
5963 1043	Data numeris (RJ45CAT5-RJ11)	120	<b>27,00 ₺</b>
5963 1044	Data priz (RJ45CAT5)	120	<b>26,40 ₺</b>
5963 1045	«kili data priz (RJ45CAT5)	120	<b>43,40 ₺</b>
5963 1046	Data jaksız	120	<b>6,40 ₺</b>
5963 1047	Data priz (RJ45CAT6)	120	<b>26,40 ₺</b>
5963 1048	«kili data priz (RJ45CAT6)	120	<b>43,40 ₺</b>
5963 1049	Data - Numeris (RJ45CAT6-RJ11)	120	<b>27,00 ₺</b>
5963 1050	Müzik Yayın Prizi	80	<b>53,60 ₺</b>
5963 1052	VGA Prizi	80	<b>83,60 ₺</b>
5963 1059	Müzik yayın anahtarı	80	<b>37,70 ₺</b>
<b>Dimmer Grubu</b>			
5963 1055	Dimmer 600W	80	<b>31,50 ₺</b>
5963 1056	Dimmer 1000W	80	<b>34,25 ₺</b>
5963 1057	Dimmer vavien 600W	80	<b>63,00 ₺</b>
5963 1058	Dimmer RC 300W	80	<b>68,65 ₺</b>
<b>Işıklı Anahtar Grubu</b>			
5963 1070	Işıklı anahtar	120	<b>7,70 ₺</b>
5963 1071	Işıklı light	120	<b>7,90 ₺</b>
5963 1072	Işıklı komitatör	120	<b>9,00 ₺</b>
5963 1073	Işıklı vavien	120	<b>9,00 ₺</b>
5963 1074	Işıklı etiketli zil	120	<b>8,80 ₺</b>
5963 1075	Işıklı dimmer 600W	80	<b>32,90 ₺</b>
5963 1076	Işıklı dimmer 1000W	80	<b>32,90 ₺</b>
5963 1077	Işıklı dimmer vavien 600W	80	<b>64,40 ₺</b>
5963 1078	Işıklı dimmer RC 300W	80	<b>70,00 ₺</b>
<b>Çerçeveler</b>			
5963 1081	2'li çerçeve yatay-dikey	200	<b>3,80 ₺</b>
5963 1082	3'lü çerçeve yatay-dikey	150	<b>4,70 ₺</b>
5963 1083	4'lü çerçeve yatay-dikey	50	<b>6,10 ₺</b>
5963 1084	5'li çerçeve yatay-dikey	50	<b>7,60 ₺</b>
5963 1085	6'lı çerçeve yatay-dikey	50	<b>9,00 ₺</b>

## Keira Beyaz Anahtar ve Priz Serisi

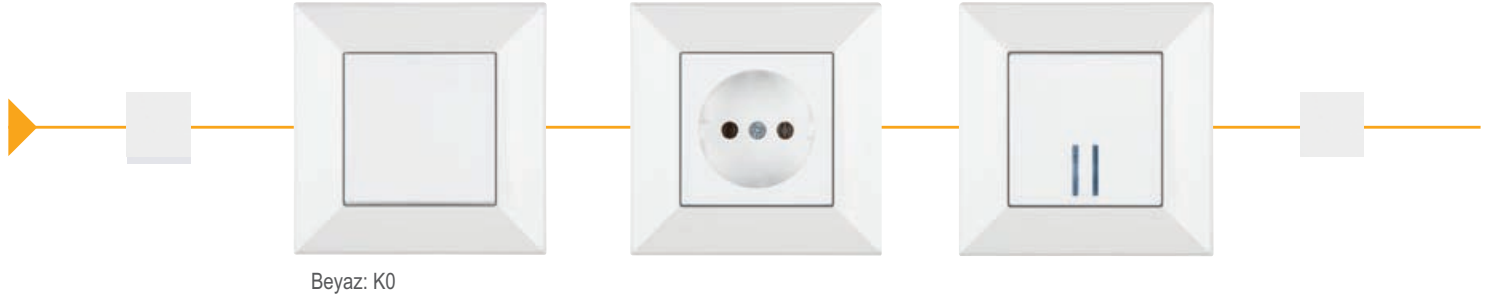

## Keira Krem Anahtar ve Priz Serisi

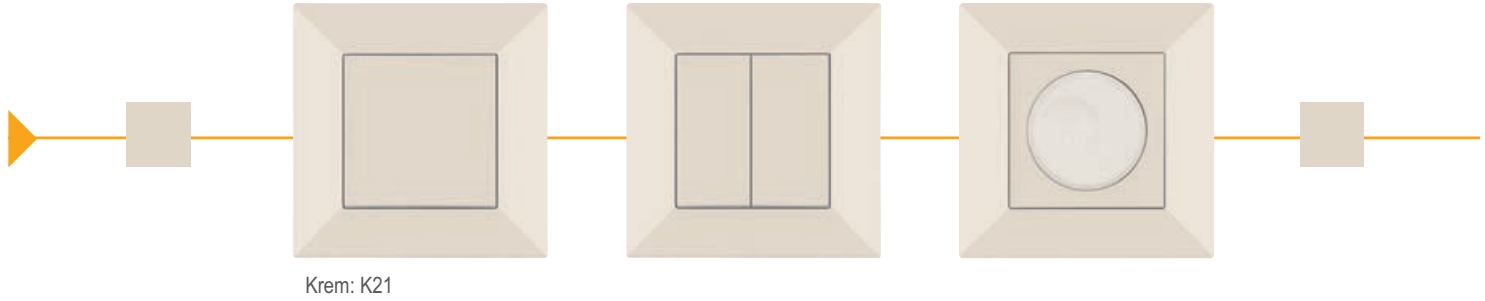

Kod No	Cinsi	Koli Ad.	Keira Beyaz & Krem Seri
<b>Anahtar Grubu</b>			
5963 1001	Anahtar	120	4,90 ₺
5963 1002	Light	120	5,20 ₺
5963 1003	Kapı otomatığı	120	5,20 ₺
5963 1004	Zil anahtarı	120	5,20 ₺
5963 1005	Komitatör	120	6,00 ₺
5963 1006	Vavien	120	6,00 ₺
5963 1007	Permatör	120	7,70 ₺
5963 1008	Komitatör vavien	120	8,40 ₺
5963 1009	Jaluzi anahtarı	120	9,85 ₺
5963 1010	Şofben anahtarı	120	15,85 ₺
5963 1011	3'lü anahtar	120	13,40 ₺
<b>Priz Grubu</b>			
5963 1014	Priz	120	4,90 ₺
5963 1015	Topraklı priz	120	5,90 ₺
5963 1016	Çocuk korumalı topraklı priz	120	8,00 ₺
5963 1017	UPS topraklı priz	120	7,70 ₺
5963 1018	UPS çocuk korumalı topraklı priz	120	8,00 ₺
5963 1019	Kapaklı topraklı priz	120	6,85 ₺
5963 1020	Çocuk korumalı kapaklı topraklı priz	120	9,40 ₺
5963 1021	UPS kapaklı topraklı priz	120	12,60 ₺
5963 1023	ikili priz	100	6,70 ₺
5963 1024	ikili topraklı priz	70	7,30 ₺
<b>TV/Radyo Grubu</b>			
5963 1030	TV priz geçişli	120	9,30 ₺
5963 1031	TV priz sonlu	120	9,30 ₺
5963 1032	TV priz dirençsiz	120	9,30 ₺
5963 1033	Uydu prizi F komnektörlü geçişli	120	14,00 ₺
5963 1034	Uydu prizi F komnektörlü sonlu	120	14,00 ₺
5963 1035	TV - Radyo priz geçişli	120	25,25 ₺
5963 1036	TV - Radyo priz sonlu	120	25,25 ₺
5963 1037	TV - Sat priz geçişli	120	39,15 ₺
5963 1038	TV - Sat priz sonlu	120	39,15 ₺

Kod No	Cinsi	Koli Ad.	Keira Beyaz & Krem Seri
<b>iletışim Grubu</b>			
5963 1040	Telefon prizi	120	4,90 ₺
5963 1041	Numeris telefon prizi (RJ11)	120	6,60 ₺
5963 1042	ikili numeris (RJ11)	120	10,50 ₺
5963 1043	Data numeris (RJ45CAT5-RJ11)	120	26,30 ₺
5963 1044	Data priz (RJ45CAT5)	120	25,25 ₺
5963 1045	ikili data priz (RJ45CAT5)	120	42,00 ₺
5963 1046	Data jaksız	120	6,00 ₺
5963 1047	Data priz (RJ45CAT6)	120	25,25 ₺
5963 1048	ikili data priz (RJ45CAT6)	120	42,00 ₺
5963 1049	Data - Numeris (RJ45CAT6-RJ11)	120	26,30 ₺
5963 1050	Müzik Yayın Prizi	80	52,15 ₺
5963 1052	VGA Prizi	80	82,20 ₺
5963 1059	Müzik yayın anahtarı	80	37,00 ₺
<b>Dimmer Grubu</b>			
5963 1055	Dimmer 600W	80	30,80 ₺
5963 1056	Dimmer 1000W	80	33,50 ₺
5963 1057	Dimmer vavien 600W	80	61,60 ₺
5963 1058	Dimmer RC 300W	80	67,20 ₺
<b>Işıklı Anahtar Grubu</b>			
5963 1070	Işıklı anahtar	120	7,30 ₺
5963 1071	Işıklı light	120	7,60 ₺
5963 1072	Işıklı komitatör	120	8,75 ₺
5963 1073	Işıklı vavien	120	8,75 ₺
5963 1074	Işıklı etiketli zil	120	8,50 ₺
5963 1075	Işıklı dimmer 600W	80	32,25 ₺
5963 1076	Işıklı dimmer 1000W	80	35,00 ₺
5963 1077	Işıklı dimmer vavien 600W	80	63,00 ₺
5963 1078	Işıklı dimmer RC 300W	80	68,65 ₺
<b>Çerçeveler</b>			
5963 1081	2'li çerçeve yatay-dikey	200	3,40 ₺
5963 1082	3'lü çerçeve yatay-dikey	150	4,30 ₺
5963 1083	4'lü çerçeve yatay-dikey	50	5,80 ₺
5963 1084	5'li çerçeve yatay-dikey	50	7,20 ₺
5963 1085	6'lı çerçeve yatay-dikey	50	8,60 ₺

Konfigürasyon: Beyaz: K0  
Krem: K21



### Keira Füme Anahtar ve Priz Serisi



### Keira Saten Anahtar ve Priz Serisi

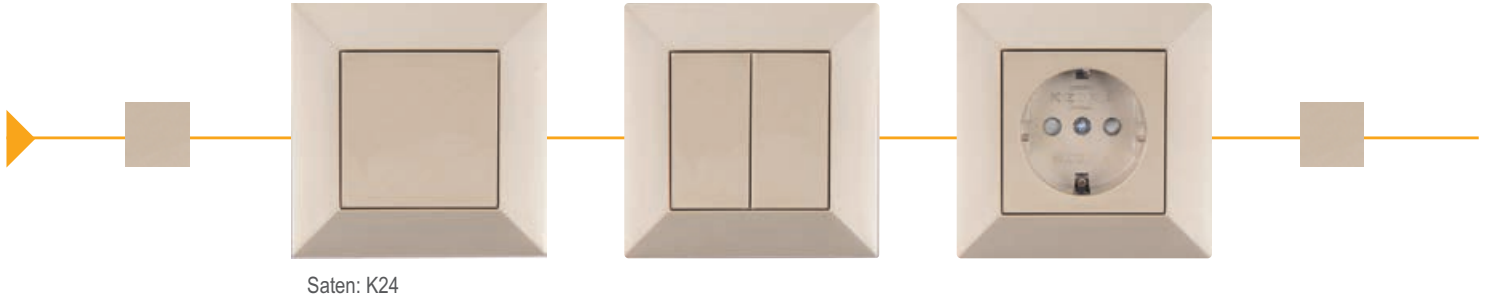

Kod No	Cinsi	Koli Ad.	Keira Metalik Seri
<b>Anahtar Grubu</b>			
5963 1001	Anahtar	120	8,85 ₺
5963 1002	Light	120	9,20 ₺
5963 1003	Kapı otomatığı	120	9,20 ₺
5963 1004	Zil anahtarı	120	9,20 ₺
5963 1005	Komitatör	120	10,00 ₺
5963 1006	Vavien	120	10,00 ₺
5963 1007	Permitatör	120	11,75 ₺
5963 1008	Komitatör vavien	120	12,50 ₺
5963 1009	Jaluzi anahtar	120	13,90 ₺
5963 1010	Şofben anahtarı	120	20,80 ₺
5963 1011	3'lü anahtar	120	18,25 ₺
<b>Priz Grubu</b>			
5963 1014	Priz	120	8,85 ₺
5963 1015	Topraklı priz	120	9,90 ₺
5963 1016	Çocuk korumalı topraklı priz	120	12,15 ₺
5963 1017	UPS topraklı priz	120	11,75 ₺
5963 1018	UPS çocuk korumalı topraklı priz	120	12,00 ₺
5963 1019	Kapaklı topraklı priz	120	10,90 ₺
5963 1020	Çocuk korumalı kapaklı topraklı priz	120	13,50 ₺
5963 1021	UPS kapaklı topraklı priz	120	16,75 ₺
5963 1023	ikili priz	100	10,75 ₺
5963 1024	ikili topraklı priz	70	11,30 ₺
<b>TV/Radyo Grubu</b>			
5963 1030	TV priz geçişli	120	13,35 ₺
5963 1031	TV priz sonlu	120	13,35 ₺
5963 1032	TV priz dirençsiz	120	13,35 ₺
5963 1033	Uydu prizi F komnektörlü geçişli	120	18,25 ₺
5963 1034	Uydu prizi F komnektörlü sonlu	120	18,25 ₺
5963 1035	TV - Radyo priz geçişli	120	29,90 ₺
5963 1036	TV - Radyo priz sonlu	120	29,90 ₺
5963 1037	TV - Sat priz geçişli	120	44,40 ₺
5963 1038	TV - Sat priz sonlu	120	44,40 ₺

Kod No	Cinsi	Koli Ad.	Keira Metalik Seri
<b>İletişim Grubu</b>			
5963 1040	Telefon prizi	120	8,85 ₺
5963 1041	Numeris telefon prizi (RJ11)	120	10,60 ₺
5963 1042	ikili numeris (RJ11)	120	14,60 ₺
5963 1043	Data numeris (RJ45CAT5-RJ11)	120	31,00 ₺
5963 1044	Data priz (RJ45CAT5)	120	29,90 ₺
5963 1045	ikili data priz (RJ45CAT5)	120	47,30 ₺
5963 1046	Data jaksız	120	10,00 ₺
5963 1047	Data priz (RJ45CAT6)	120	29,90 ₺
5963 1048	ikili data priz (RJ45CAT6)	120	47,30 ₺
5963 1049	Data - Numeris (RJ45CAT6-RJ11)	120	31,00 ₺
5963 1050	Müzik Yayın Prizi	80	58,30 ₺
5963 1052	VGA Prizi	80	90,40 ₺
5963 1059	Müzik yayın anahtarı	80	42,00 ₺
<b>Dimmer Grubu</b>			
5963 1055	Dimmer 600W	80	36,60 ₺
5963 1056	Dimmer 1000W	80	34,45 ₺
5963 1057	Dimmer vavien 600W	80	67,55 ₺
5963 1058	Dimmer RC 300W	80	73,40 ₺
<b>Işıklı Anahtar Grubu</b>			
5963 1070	Işıklı anahtar	120	11,40 ₺
5963 1071	Işıklı light	120	11,70 ₺
5963 1072	Işıklı komitatör	120	12,80 ₺
5963 1073	Işıklı vavien	120	12,80 ₺
5963 1074	Işıklı etiketli zil	120	12,50 ₺
5963 1075	Işıklı dimmer 600W	80	37,00 ₺
5963 1076	Işıklı dimmer 1000W	80	40,00 ₺
5963 1077	Işıklı dimmer vavien 600W	80	63,15 ₺
5963 1078	Işıklı dimmer RC 300W	80	74,80 ₺
<b>Çerçeveler</b>			
5963 1081	2'li çerçeve yatay-dikey	200	7,30 ₺
5963 1082	3'lü çerçeve yatay-dikey	150	8,25 ₺
5963 1083	4'lü çerçeve yatay-dikey	50	9,70 ₺
5963 1084	5'li çerçeve yatay-dikey	50	11,20 ₺
5963 1085	6'lı çerçeve yatay-dikey	50	12,70 ₺



## Keira Kiraz Anahtar ve Priz Serisi

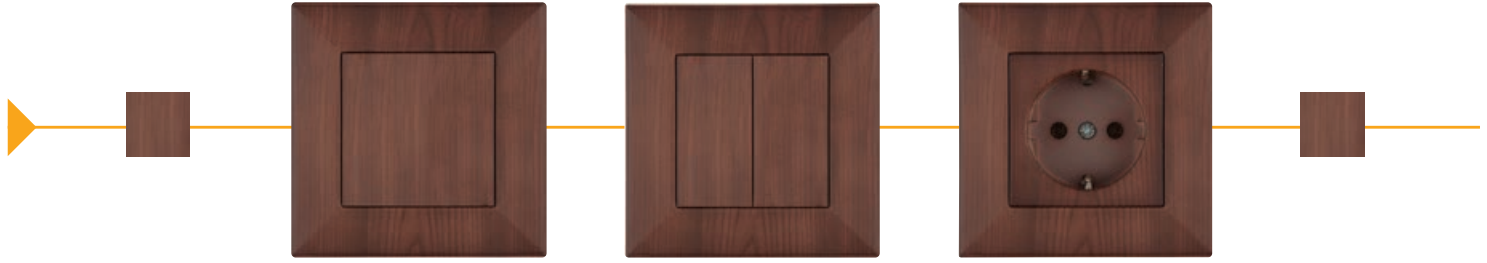

Kiraz: K23

## Keira Meşe Anahtar ve Priz Serisi

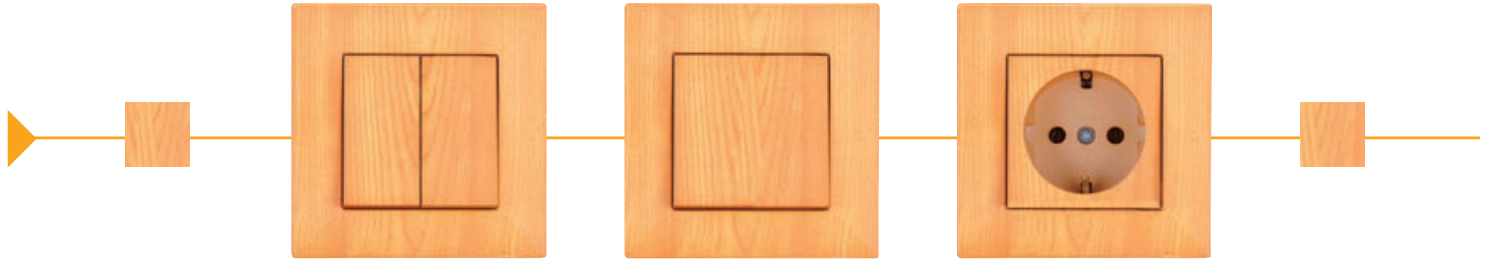

Meşe: K22

Kod No	Cinsi	Koli Ad.	Keira Ahşap Serisi
<b>Anahtar Grubu</b>			
5963 1001	Anahtar	120	9,25 ₺
5963 1002	Light	120	12,40 ₺
5963 1003	Kapı otomatığı	120	12,40 ₺
5963 1004	Zil anahtarı	120	12,40 ₺
5963 1005	Komitatör	120	13,55 ₺
5963 1006	Vavien	120	13,55 ₺
5963 1007	Permitatör	120	12,00 ₺
5963 1008	Komitatör vavien	120	12,80 ₺
5963 1009	Jaluzi anahtarı	120	14,10 ₺
5963 1010	Şofben anahtarı	120	20,90 ₺
5963 1011	3'lü anahtar	120	18,40 ₺
<b>Priz Grubu</b>			
5963 1014	Priz	120	9,30 ₺
5963 1015	Topraklı priz	120	10,30 ₺
5963 1016	Çocuk korumalı topraklı priz	120	12,40 ₺
5963 1017	UPS topraklı priz	120	12,00 ₺
5963 1018	UPS çocuk korumalı topraklı priz	120	12,30 ₺
5963 1019	Kapaklı topraklı priz	120	11,15 ₺
5963 1020	Çocuk korumalı kapaklı topraklı priz	120	13,75 ₺
5963 1021	UPS kapaklı topraklı priz	120	16,85 ₺
5963 1023	ikili priz	100	11,10 ₺
5963 1024	ikili topraklı priz	70	11,55 ₺
<b>TV/Radyo Grubu</b>			
5963 1030	TV priz geçişli	120	13,50 ₺
5963 1031	TV priz sonlu	120	13,50 ₺
5963 1032	TV priz dirençsiz	120	13,50 ₺
5963 1033	Uydu prizi F konnektörlü geçişli	120	18,35 ₺
5963 1034	Uydu prizi F konnektörlü sonlu	120	18,35 ₺
5963 1035	TV - Radyo priz geçişli	120	42,30 ₺
5963 1036	TV - Radyo priz sonlu	120	42,30 ₺
5963 1037	TV - Sat priz geçişli	120	43,60 ₺
5963 1038	TV - Sat priz sonlu	120	43,60 ₺

Kod No	Cinsi	Koli Ad.	Keira Ahşap Serisi
<b>iletişim Grubu</b>			
5963 1040	Telefon prizi	120	9,30 ₺
5963 1041	Numeris telefon prizi (RJ11)	120	10,80 ₺
5963 1042	ikili numeris (RJ11)	120	14,80 ₺
5963 1043	Data numeris (RJ45CAT5-RJ11)	120	30,60 ₺
5963 1044	Data priz (RJ45CAT5)	120	42,30 ₺
5963 1045	ikili data priz (RJ45CAT5)	120	46,30 ₺
5963 1046	Data jaksız	120	10,40 ₺
5963 1047	Data priz (RJ45CAT6)	120	42,30 ₺
5963 1048	ikili data priz (RJ45CAT6)	120	46,30 ₺
5963 1049	Data - Numeris (RJ45CAT6-RJ11)	120	30,60 ₺
5963 1050	Müzik Yayın Prizi	80	57,10 ₺
5963 1052	VGA Prizi	80	86,50 ₺
5963 1059	Müzik yayın anahtarı	80	41,30 ₺
<b>Dimmer Grubu</b>			
5963 1055	Dimmer 600W	80	35,10 ₺
5963 1056	Dimmer 1000W	80	38,00 ₺
5963 1057	Dimmer vavien 600W	80	65,90 ₺
5963 1058	Dimmer RC 300W	80	71,50 ₺
<b>Işıklı Anahtar Grubu</b>			
5963 1070	Işıklı anahtar	120	11,60 ₺
5963 1071	Işıklı light	120	12,00 ₺
5963 1072	Işıklı komitatör	120	13,00 ₺
5963 1073	Işıklı vavien	120	13,00 ₺
5963 1074	Işıklı etiketli zil	120	12,80 ₺
5963 1075	Işıklı dimmer 600W	80	36,55 ₺
5963 1076	Işıklı dimmer 1000W	80	39,30 ₺
5963 1077	Işıklı dimmer vavien 600W	80	61,70 ₺
5963 1078	Işıklı dimmer RC 300W	80	72,95 ₺
<b>Çerçeveler</b>			
5963 1081	2'li çerçeve yatay-dikey	200	7,70 ₺
5963 1082	3'lü çerçeve yatay-dikey	150	8,60 ₺
5963 1083	4'lü çerçeve yatay-dikey	50	10,10 ₺
5963 1084	5'li çerçeve yatay-dikey	50	11,50 ₺
5963 1085	6'lı çerçeve yatay-dikey	50	12,90 ₺

Konfigürasyon: Kiraz: K23  
Meşe: K22



## Keira Cam-Corlan



## Keira Mermer Anahtar ve Priz Serisi



Kod No	Cinsi	Koli Ad.	Keira Cam ve Mermer Serisi
<b>Anahtar Grubu</b>			
5963 1001	Anahtar	120	<b>35,80 ₺</b>
5963 1002	Light	120	<b>36,10 ₺</b>
5963 1003	Kapı otomatığı	120	<b>36,10 ₺</b>
5963 1004	Zil anahtarı	120	<b>36,10 ₺</b>
5963 1005	Komitatör	120	<b>37,00 ₺</b>
5963 1006	Vavien	120	<b>37,00 ₺</b>
5963 1007	Permitatör	120	<b>39,00 ₺</b>
5963 1008	Komitatör vavien	120	<b>39,80 ₺</b>
5963 1009	Jaluzi anahtarı	120	<b>41,45 ₺</b>
5963 1010	Şofben anahtarı	120	<b>41,45 ₺</b>
<b>Priz Grubu</b>			
5963 1014	Priz	120	<b>35,80 ₺</b>
5963 1015	Topraklı priz	120	<b>36,90 ₺</b>
5963 1016	Çocuk korumalı topraklı priz	120	<b>39,50 ₺</b>
5963 1017	UPS topraklı priz	120	<b>39,00 ₺</b>
5963 1018	UPS çocuk korumalı topraklı priz	120	<b>39,30 ₺</b>
5963 1019	Kapaklı topraklı priz	120	<b>38,00 ₺</b>
5963 1020	Çocuk korumalı kapaklı topraklı priz	120	<b>41,00 ₺</b>
5963 1021	UPS kapaklı topraklı priz	120	<b>44,70 ₺</b>
<b>TV/Radyo Grubu</b>			
5963 1030	TV priz geçişli	120	<b>40,85 ₺</b>
5963 1031	TV priz sonlu	120	<b>40,85 ₺</b>
5963 1032	TV priz dirençsiz	120	<b>40,85 ₺</b>
5963 1033	Uydu prizi F komnektörlü geçişli	120	<b>46,40 ₺</b>
5963 1034	Uydu prizi F komnektörlü sonlu	120	<b>46,30 ₺</b>
5963 1035	TV - Radyo priz geçişli	120	<b>59,30 ₺</b>
5963 1036	TV - Radyo priz sonlu	120	<b>59,30 ₺</b>
5963 1037	TV - Sat priz geçişli	120	<b>75,60 ₺</b>
5963 1038	TV - Sat priz sonlu	120	<b>75,60 ₺</b>

Kod No	Cinsi	Koli Ad.	Keira Cam ve Mermer Serisi
<b>iletişim Grubu</b>			
5963 1040	Telefon prizi	120	<b>35,80 ₺</b>
5963 1041	Numeris telefon prizi (RJ11)	120	<b>37,65 ₺</b>
5963 1042	ikili numeris (RJ11)	120	<b>42,30 ₺</b>
5963 1043	Data numeris (RJ45CAT5-RJ11)	120	<b>60,70 ₺</b>
5963 1044	Data priz (RJ45CAT5)	120	<b>59,30 ₺</b>
5963 1045	ikili data priz (RJ45CAT5)	120	<b>78,90 ₺</b>
5963 1046	Data jaksız	120	<b>37,00 ₺</b>
5963 1047	Data priz (RJ45CAT6)	120	<b>59,30 ₺</b>
5963 1048	ikili data priz (RJ45CAT6)	120	<b>78,95 ₺</b>
5963 1049	Data - Numeris (RJ45CAT6-RJ11)	120	<b>60,70 ₺</b>
5963 1050	Müzik Yayın Prizi	80	<b>82,20 ₺</b>
5963 1052	VGA Prizi	80	<b>96,00 ₺</b>
5963 1059	Müzik yayın anahtarı	80	<b>73,00 ₺</b>
<b>Dimmer Grubu</b>			
5963 1055	Dimmer 600W	80	<b>65,90 ₺</b>
5963 1056	Dimmer 1000W	80	<b>69,15 ₺</b>
5963 1057	Dimmer vavien 600W	80	<b>101,70 ₺</b>
5963 1058	Dimmer RC 300W	80	<b>108,30 ₺</b>
<b>Işıklı Anahtar Grubu</b>			
5963 1070	Işıklı anahtar	120	<b>38,60 ₺</b>
5963 1071	Işıklı light	120	<b>38,90 ₺</b>
5963 1072	Işıklı komitatör	120	<b>40,25 ₺</b>
5963 1073	Işıklı vavien	120	<b>40,25 ₺</b>
5963 1074	Işıklı etiketli zil	120	<b>39,85 ₺</b>
5963 1075	Işıklı dimmer 600W	80	<b>67,55 ₺</b>
5963 1076	Işıklı dimmer 1000W	80	<b>70,75 ₺</b>
5963 1077	Işıklı dimmer vavien 600W	80	<b>103,35 ₺</b>
5963 1078	Işıklı dimmer RC 300W	80	<b>109,80 ₺</b>
<b>Çerçeveler</b>			
5963 1081	2'li çerçeve yatay-dikey	200	<b>37,50 ₺</b>
5963 1082	3'lü çerçeve yatay-dikey	150	<b>40,70 ₺</b>

## Onyx Beyaz Anahtar ve Priz Serisi



## Onyx Krem Anahtar ve Priz Serisi



Kod No	Cinsi	Koli Ad.	Beyaz ve Krem Seri
<b>Anahtar Grubu</b>			
5963 3001	Anahtar	120	4,90 ₺
5963 3002	Light	120	5,20 ₺
5963 3003	Kapı otomatığı	120	5,20 ₺
5963 3004	Zil anahtarı	120	5,20 ₺
5963 3005	Komitatör	120	6,00 ₺
5963 3006	Vavien	120	6,00 ₺
5963 3007	Permitatör	120	7,70 ₺
5963 3008	Komitatör vavien	120	8,40 ₺
5963 3009	Jaluzi anahtarı	120	9,85 ₺
5963 3010	Şofben anahtarı	120	15,85 ₺
5963 3011	3'lü anahtar	120	13,40 ₺
<b>Priz Grubu</b>			
5963 3014	Priz	120	4,90 ₺
5963 3015	Topraklı priz	120	5,90 ₺
5963 3016	Çocuk korumalı topraklı priz	120	8,00 ₺
5963 3017	UPS topraklı priz	120	7,70 ₺
5963 3018	UPS çocuk korumalı topraklı priz	120	8,00 ₺
5963 3019	Kapaklı topraklı priz	120	6,85 ₺
5963 3020	Çocuk korumalı kapaklı topraklı priz	120	9,40 ₺
5963 3021	UPS kapaklı topraklı priz	120	12,60 ₺
5963 3023	ikili priz	100	6,70 ₺
5963 3024	ikili topraklı priz	70	7,30 ₺
<b>TV/Radyo Grubu</b>			
5963 3030	TV priz geçişi	120	9,30 ₺
5963 3031	TV priz sonlu	120	9,30 ₺
5963 3032	TV priz dirençsiz	120	9,30 ₺
5963 3033	Uydu prizi F komnektörlü geçişli	120	14,00 ₺
5963 3034	Uydu prizi F komnektörlü sonlu	120	14,00 ₺
5963 3035	TV - Radyo priz geçişli	120	25,25 ₺
5963 3036	TV - Radyo priz sonlu	120	25,25 ₺
5963 3037	TV - Sat priz geçişi	120	39,15 ₺
5963 3038	TV - Sat priz sonlu	120	39,15 ₺

Kod No	Cinsi	Koli Ad.	Beyaz ve Krem Seri
<b>İletişim Grubu</b>			
5963 3040	Telefon prizi	120	4,90 ₺
5963 3041	Numeris telefon prizi (RJ11)	120	6,60 ₺
5963 3042	ikili numeris (RJ11)	120	10,50 ₺
5963 3043	Data numeris (RJ45CAT5-RJ11)	120	26,30 ₺
5963 3044	Data priz (RJ45CAT5)	120	25,25 ₺
5963 3045	ikili data priz (RJ45CAT5)	120	42,00 ₺
5963 3046	Data jaksız	120	6,00 ₺
5963 3047	Data priz (RJ45CAT6)	120	25,25 ₺
5963 3048	ikili data priz (RJ45CAT6)	120	42,00 ₺
5963 3049	Data - Numeris (RJ45CAT6-RJ11)	120	26,30 ₺
5963 3050	Müzik Yayın Prizi	80	52,15 ₺
5963 3052	VGA Prizi	80	82,20 ₺
5963 3059	Müzik yayın anahtarı	80	37,00 ₺
<b>Dimmer Grubu</b>			
5963 3055	Dimmer 600W	80	30,80 ₺
5963 3056	Dimmer 1000W	80	33,55 ₺
5963 3057	Dimmer vavien 600W	80	61,60 ₺
5963 3058	Dimmer RC 300W	80	67,20 ₺
<b>Işıklı Anahtar Grubu</b>			
5963 3070	Işıklı anahtar	120	7,30 ₺
5963 3071	Işıklı light	120	7,60 ₺
5963 3072	Işıklı komitatör	120	8,75 ₺
5963 3073	Işıklı vavien	120	8,75 ₺
5963 3074	Işıklı etiketli zil	120	8,50 ₺
5963 3075	Işıklı dimmer 600W	80	32,25 ₺
5963 3076	Işıklı dimmer 1000W	80	35,00 ₺
5963 3077	Işıklı dimmer vavien 600W	80	63,00 ₺
5963 3078	Işıklı dimmer RC 300W	80	68,65 ₺
<b>Çerçeveler</b>			
5963 3081	2'li çerçeve yatay-dikey	200	3,40 ₺
5963 3082	3'lü çerçeve yatay-dikey	150	4,30 ₺
5963 3083	4'lü çerçeve yatay-dikey	50	5,80 ₺
5963 3084	5'li çerçeve yatay-dikey	50	7,20 ₺
5963 3085	6'lı çerçeve yatay-dikey		8,60 ₺

Konfigürasyon: Beyaz: K0  
Krem: K21



### Onyx Beyaz Anahtar ve Priz Serisi



Füme: K25

### Onyx Saten Anahtar ve Priz Serisi



Saten: K24

Kod No	Cinsi	Koli Ad.	Onyx Metalik Seri
<b>Anahtar Grubu</b>			
5963 3001	Anahtar	120	8,85 ₺
5963 3002	Light	120	9,20 ₺
5963 3003	Kapı otomatığı	120	9,20 ₺
5963 3004	Zil anahtarı	120	9,20 ₺
5963 3005	Komitatör	120	10,00 ₺
5963 3006	Vavien	120	10,00 ₺
5963 3007	Permitatör	120	11,75 ₺
5963 3008	Komitatör vavien	120	12,50 ₺
5963 3009	Jaluzi anahtar	120	13,90 ₺
5963 3010	Şofben anahtarı	120	20,80 ₺
5963 3011	3'lü anahtar	120	18,25 ₺
<b>Priz Grubu</b>			
5963 3014	Priz	120	8,85 ₺
5963 3015	Topraklı priz	120	9,90 ₺
5963 3016	Çocuk korumalı topraklı priz	120	12,15 ₺
5963 3017	UPS topraklı priz	120	11,75 ₺
5963 3018	UPS çocuk korumalı topraklı priz	120	12,00 ₺
5963 3019	Kapaklı topraklı priz	120	10,90 ₺
5963 3020	Çocuk korumalı kapaklı topraklı priz	120	13,50 ₺
5963 3021	UPS kapaklı topraklı priz	120	16,75 ₺
5963 3023	İkili priz	100	10,75 ₺
5963 3024	İkili topraklı priz	70	11,30 ₺
<b>TV/Radyo Grubu</b>			
5963 3030	TV priz geçişli	120	13,35 ₺
5963 3031	TV priz sonlu	120	13,35 ₺
5963 3032	TV priz dirençsiz	120	13,35 ₺
5963 3033	Uydu prizi F konnektörlü geçişli	120	18,25 ₺
5963 3034	Uydu prizi F konnektörlü sonlu	120	18,25 ₺
5963 3035	TV - Radyo priz geçişli	120	29,90 ₺
5963 3036	TV - Radyo priz sonlu	120	29,90 ₺
5963 3037	TV - Sat priz geçişli	120	44,40 ₺
5963 3038	TV - Sat priz sonlu	120	44,40 ₺

Kod No	Cinsi	Koli Ad.	Onyx Metalik Seri
<b>İletişim Grubu</b>			
5963 3040	Telefon prizi	120	8,85 ₺
5963 3041	Numeris telefon prizi (RJ11)	120	10,60 ₺
5963 3042	İkili numeris (RJ11)	120	14,60 ₺
5963 3043	Data numeris (RJ45CAT5-RJ11)	120	31,00 ₺
5963 3044	Data priz (RJ45CAT5)	120	29,90 ₺
5963 3045	İkili data priz (RJ45CAT5)	120	47,30 ₺
5963 3046	Data jaksız	120	10,00 ₺
5963 3047	Data priz (RJ45CAT6)	120	29,90 ₺
5963 3048	İkili data priz (RJ45CAT6)	120	47,30 ₺
5963 3049	Data - Numeris (RJ45CAT6-RJ11)	120	31,00 ₺
5963 3050	Müzik Yayın Prizi	80	58,30 ₺
5963 3052	VGA Prizi	80	90,40 ₺
5963 3059	Müzik yayın anahtarı	80	42,00 ₺
<b>Dimmer Grubu</b>			
5963 3055	Dimmer 600W	80	36,60 ₺
5963 3056	Dimmer 1000W	80	34,45 ₺
5963 3057	Dimmer vavien 600W	80	67,55 ₺
5963 3058	Dimmer RC 300W	80	73,40 ₺
<b>İkili Anahtar Grubu</b>			
5963 3070	İşıkli anahtar	120	11,40 ₺
5963 3071	İşıkli light	120	11,70 ₺
5963 3072	İşıkli komitatör	120	12,80 ₺
5963 3073	İşıkli vavien	120	12,80 ₺
5963 3074	İşıkli etiketli zil	120	12,50 ₺
5963 3075	İşıkli dimmer 600W	80	37,00 ₺
5963 3076	İşıkli dimmer 1000W	80	40,00 ₺
5963 3077	İşıkli dimmer vavien 600W	80	63,15 ₺
5963 3078	İşıkli dimmer RC 300W	80	74,80 ₺
<b>Çerçeveler</b>			
5963 3081	2'li çerçeve yatay-dikey	200	7,30 ₺
5963 3082	3'lü çerçeve yatay-dikey	150	8,25 ₺
5963 3083	4'lü çerçeve yatay-dikey	50	9,70 ₺
5963 3084	5'li çerçeve yatay-dikey	50	11,20 ₺
5963 3085	6'lı çerçeve yatay-dikey	50	12,70 ₺

## Onyx Kiraz Anahtar ve Priz Serisi



Kiraz: K23

## Onyx Meşe Anahtar ve Priz Serisi

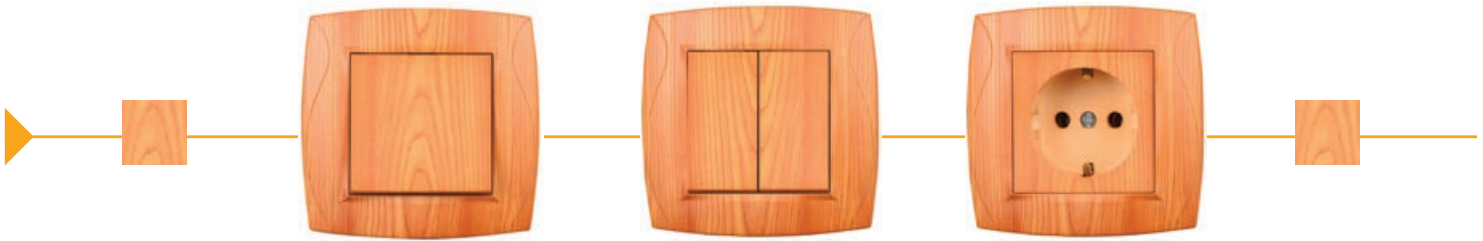

Meşe: K22

Kod No	Cinsi	Koli Ad.	Onyx Ahşap Seri
<b>Anahtar Grubu</b>			
5963 3001	Anahtar	120	<b>9,25 ₺</b>
5963 3002	Light	120	<b>12,40 ₺</b>
5963 3003	Kapı otomatığı	120	<b>12,40 ₺</b>
5963 3004	Zil anahtarı	120	<b>12,40 ₺</b>
5963 3005	Komitatör	120	<b>13,55 ₺</b>
5963 3006	Vavien	120	<b>13,55 ₺</b>
5963 3007	Permitatör	120	<b>12,00 ₺</b>
5963 3008	Komitatör vavien	120	<b>12,80 ₺</b>
5963 3009	Jaluzi anahtarı	120	<b>14,10 ₺</b>
5963 3010	Şofben anahtarı	120	<b>20,90 ₺</b>
5963 3011	3'lü anahtar	120	<b>18,40 ₺</b>
<b>Priz Grubu</b>			
5963 3014	Priz	120	<b>9,30 ₺</b>
5963 3015	Topraklı priz	120	<b>10,30 ₺</b>
5963 3016	Çocuk korumalı topraklı priz	120	<b>12,40 ₺</b>
5963 3017	UPS topraklı priz	120	<b>12,00 ₺</b>
5963 3018	UPS çocuk korumalı topraklı priz	120	<b>12,30 ₺</b>
5963 3019	Kapaklı topraklı priz	120	<b>11,15 ₺</b>
5963 3020	Çocuk korumalı kapaklı topraklı priz	120	<b>13,75 ₺</b>
5963 3021	UPS kapaklı topraklı priz	120	<b>16,85 ₺</b>
5963 3023	ikili priz	100	<b>11,10 ₺</b>
5963 3024	ikili topraklı priz	70	<b>11,55 ₺</b>
<b>TV/Radyo Grubu</b>			
5963 3030	TV priz geçişli	120	<b>13,50 ₺</b>
5963 3031	TV priz sonlu	120	<b>13,50 ₺</b>
5963 3032	TV priz dirençsiz	120	<b>13,50 ₺</b>
5963 3033	Uydu prizi F konnektörü geçişli	120	<b>18,35 ₺</b>
5963 3034	Uydu prizi F konnektörü sonlu	120	<b>18,35 ₺</b>
5963 3035	TV - Radyo priz geçişli	120	<b>42,30 ₺</b>
5963 3036	TV - Radyo priz sonlu	120	<b>42,30 ₺</b>
5963 3037	TV - Sat priz geçişli	120	<b>43,60 ₺</b>
5963 3038	TV - Sat priz sonlu	120	<b>43,60 ₺</b>

Kod No	Cinsi	Koli Ad.	Onyx Ahşap Seri
<b>iletişim Grubu</b>			
5963 3040	Telefon prizi	120	<b>9,30 ₺</b>
5963 3041	Numeris telefon prizi (RJ11)	120	<b>10,80 ₺</b>
5963 3042	ikili numeris (RJ11)	120	<b>14,80 ₺</b>
5963 3043	Data numeris (RJ45CAT5-RJ11)	120	<b>30,60 ₺</b>
5963 3044	Data priz (RJ45CAT5)	120	<b>42,30 ₺</b>
5963 3045	ikili data priz (RJ45CAT5)	120	<b>46,30 ₺</b>
5963 3046	Data jaksız	120	<b>10,40 ₺</b>
5963 3047	Data priz (RJ45CAT6)	120	<b>42,30 ₺</b>
5963 3048	ikili data priz (RJ45CAT6)	120	<b>46,30 ₺</b>
5963 3049	Data - Numeris (RJ45CAT6-RJ11)	120	<b>30,60 ₺</b>
5963 3050	Müzik Yayın Prizi	80	<b>57,10 ₺</b>
5963 3052	VGA Prizi	80	<b>86,50 ₺</b>
5963 3059	Müzik yayın anahtarı	80	<b>41,30 ₺</b>
<b>Dimmer Grubu</b>			
5963 3055	Dimmer 600W	80	<b>35,10 ₺</b>
5963 3056	Dimmer 1000W	80	<b>38,00 ₺</b>
5963 3057	Dimmer vavien 600W	80	<b>65,90 ₺</b>
5963 3058	Dimmer RC 300W	80	<b>71,50 ₺</b>
<b>Işıklı Anahtar Grubu</b>			
5963 3070	Işıklı anahtar	120	<b>11,60 ₺</b>
5963 3071	Işıklı light	120	<b>12,00 ₺</b>
5963 3072	Işıklı komitatör	120	<b>13,00 ₺</b>
5963 3073	Işıklı vavien	120	<b>13,00 ₺</b>
5963 3074	Işıklı etiketli zil	120	<b>12,80 ₺</b>
5963 3075	Işıklı dimmer 600W	80	<b>36,55 ₺</b>
5963 3076	Işıklı dimmer 1000W	80	<b>39,30 ₺</b>
5963 3077	Işıklı dimmer vavien 600W	80	<b>61,70 ₺</b>
5963 3078	Işıklı dimmer RC 300W	80	<b>72,95 ₺</b>
<b>Çerçeveler</b>			
5963 3081	2'li çerçeve yatay-dikey	200	<b>7,70 ₺</b>
5963 3082	3'lü çerçeve yatay-dikey	150	<b>8,60 ₺</b>
5963 3083	4'lü çerçeve yatay-dikey	50	<b>10,10 ₺</b>
5963 3084	5'li çerçeve yatay-dikey	50	<b>11,50 ₺</b>
5963 3085	6'lı çerçeve yatay-dikey	50	<b>12,90 ₺</b>

## Urla

### Çocuk Korumalı Topraklı Grup Priz Serisi



Kod No	Cinsi	Koli Ad.	Urla Seri
Urla Çocuk Korumalı			
5951 4433	3'lü 2m Çocuk Korumalı	48	16,70 ₺
5951 4533	3'lü 3m Çocuk Korumalı	48	19,40 ₺
5951 4633	3'lü 5m Çocuk Korumalı	24	25,40 ₺
Urla Çocuk Korumalı			
5951 4455	5'li 2m Çocuk Korumalı	36	24,10 ₺
5951 4555	5'li 3m Çocuk Korumalı	36	26,80 ₺
5951 4655	5'li 5m Çocuk Korumalı	24	32,80 ₺
Urla Anahtarlı Çocuk Korumalı			
5951 4733	3'lü Anahtarlı 2m Çocuk Korumalı	48	21,80 ₺
5951 4833	3'lü Anahtarlı 3m Çocuk Korumalı	48	24,50 ₺
5951 4933	3'lü Anahtarlı 5m Çocuk Korumalı	24	30,50 ₺
Urla Anahtarlı Çocuk Korumalı			
5951 4755	5'li Anahtarlı 2m Çocuk Korumalı	36	29,20 ₺
5951 4855	5'li Anahtarlı 3m Çocuk Korumalı	36	31,10 ₺
5951 4955	5'li Anahtarlı 5m Çocuk Korumalı	24	37,90 ₺

## UPS

### Grup Priz Serisi



Kod No	Cinsi	Koli Ad.	UPS Seri
UPS Çeşme			
5951 1633	3'lü UPS Serisi Priz (klemensli)	100	12,10 ₺
5951 1733	3'lü UPS Serisi Priz (2m)	36	19,90 ₺
5951 1833	3'lü UPS Serisi Priz (3m)	36	22,70 ₺
5951 1933	3'lü UPS Serisi Priz (5m)	24	28,30 ₺
UPS Çeşme			
5951 1644	4'lü UPS Serisi (klemensli)	100	15,20 ₺
5951 1744	4'lü UPS Serisi Priz (2m)	36	23,10 ₺
5951 1844	4'lü UPS Serisi Priz (3m)	36	25,90 ₺
5951 1944	4'lü UPS Serisi Priz (5m)	24	31,50 ₺
UPS Çeşme			
5951 1666	6'lı UPS Serisi Priz (klemensli)	100	20,10 ₺
5951 1766	6'lı UPS Serisi Priz (2m)	36	27,90 ₺
5951 1866	6'lı UPS Serisi Priz (3m)	36	30,70 ₺
5951 1966	6'lı UPS Serisi Priz (5m)	24	36,30 ₺
UPS Foça Anahtarlı			
5951 2955	5'li UPS Serisi Priz (klemensli)	100	23,80 ₺
5951 2965	5'li UPS Serisi Priz (2m)	36	31,60 ₺
5951 2975	5'li UPS Serisi Priz (3m)	36	34,40 ₺
5951 2985	5'li UPS Serisi Priz (5m)	24	40,00 ₺

## Çeşme

### Grup Priz Serisi



Kod No	Cinsi	Koli Ad.	Çeşme Serisi
5951 1012	2'li klemensli	100	<b>6,50 ₺</b>
5951 1023	3'lü klemensli	100	<b>7,90 ₺</b>
5951 1034	4'lü klemensli	100	<b>12,30 ₺</b>
5951 1045	5'li klemensli	100	<b>15,00 ₺</b>
5951 1056	6'lı klemensli	100	<b>15,70 ₺</b>
5951 1112	2'li 2 m kablolu	48	<b>14,30 ₺</b>
5951 1123	3'lü 2 m kablolu	48	<b>15,70 ₺</b>
5951 1134	4'lü 2 m kablolu	36	<b>20,10 ₺</b>
5951 1145	5'li 2 m kablolu	36	<b>22,80 ₺</b>
5951 1156	6'lı 2 m kablolu	36	<b>23,50 ₺</b>
5951 1212	2'li 3 m kablolu	48	<b>17,00 ₺</b>
5951 1223	3'lü 3 m kablolu	48	<b>18,50 ₺</b>
5951 1234	4'lü 3 m kablolu	36	<b>22,90 ₺</b>
5951 1245	5'li 3 m kablolu	36	<b>25,50 ₺</b>
5951 1256	6'lı 3 m kablolu	36	<b>26,30 ₺</b>
5951 1312	2'li 5 m kablolu	24	<b>22,80 ₺</b>
5951 1323	3'lü 5 m kablolu	24	<b>24,10 ₺</b>
5951 1334	4'lü 5 m kablolu	24	<b>28,50 ₺</b>
5951 1345	5'li 5 m kablolu	24	<b>31,30 ₺</b>
5951 1356	6'lı 5 m kablolu	24	<b>31,90 ₺</b>

## Foça

### Anahtarlı Grup Priz Serisi



Kod No	Cinsi	Koli Ad.	Foça Serisi
5951 3022	2'li klemensli anahtarlı	100	<b>11,60 ₺</b>
5951 3033	3'lü klemensli anahtarlı	100	<b>13,00 ₺</b>
5951 3044	4'lü klemensli anahtarlı	100	<b>17,40 ₺</b>
5951 3055	5'li klemensli anahtarlı	100	<b>20,10 ₺</b>
5951 3066	6'lı klemensli anahtarlı	50	<b>20,80 ₺</b>
5951 3122	2'li 2 m kablolu anahtarlı	48	<b>19,40 ₺</b>
5951 3133	3'lü 2 m kablolu anahtarlı	48	<b>20,80 ₺</b>
5951 3144	4'lü 2 m kablolu anahtarlı	36	<b>25,20 ₺</b>
5951 3155	5'li 2 m kablolu anahtarlı	36	<b>27,90 ₺</b>
5951 3166	6'lı 2 m kablolu anahtarlı	36	<b>28,60 ₺</b>
5951 3222	2'li 3 m kablolu anahtarlı	48	<b>22,10 ₺</b>
5951 3233	3'lü 3 m kablolu anahtarlı	48	<b>23,60 ₺</b>
5951 3244	4'lü 3 m kablolu anahtarlı	36	<b>28,00 ₺</b>
5951 3255	5'li 3 m kablolu anahtarlı	36	<b>30,60 ₺</b>
5951 3266	6'lı 3 m kablolu anahtarlı	36	<b>31,40 ₺</b>
5951 3322	2'li 5 m kablolu anahtarlı	24	<b>27,90 ₺</b>
5951 3333	3'lü 5 m kablolu anahtarlı	24	<b>29,20 ₺</b>
5951 3344	4'lü 5 m kablolu anahtarlı	24	<b>33,60 ₺</b>
5951 3355	5'li 5 m kablolu anahtarlı	24	<b>36,40 ₺</b>
5951 3366	6'lı 5 m kablolu anahtarlı	24	<b>37,00 ₺</b>

## Gerilim Korumalı Topraklı Grup Priz



## Aksesuarlar

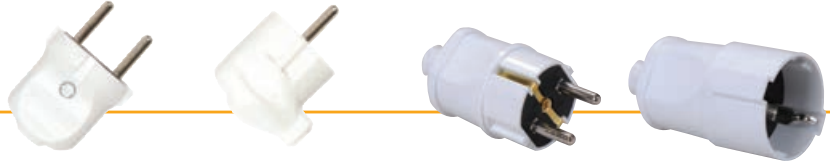

## Fişler



## Uzatma



Kod No	Cinsi	Koli Ad.	Fiş Prizler Serisi
5951 9970	6'lı 2metre gerilim korumalı beyaz	20	44,70 ₺
5951 9980	6'lı 2metre gerilim korumalı siyah	20	44,70 ₺

Kod No	Cinsi	Koli Ad.	Fiş Prizler Serisi
5951 1063	3'lü grup fiş priz	100	8,50 ₺
5951 1074	4'lü kare fiş priz	100	10,50 ₺
5951 1083	Trio fiş priz	100	8,50 ₺

Kod No	Cinsi	Koli Ad.	Aksesuar Serisi
5951 1410	Erkek fiş	1000	2,00 ₺
5951 1420	Topraklı erkek fiş	500	2,30 ₺
5951 1430	Topraklı dişi fiş	250	2,40 ₺
5951 1450	Topraklı erkek fiş L tipi	500	2,30 ₺

Kod No	Cinsi	Koli Ad.	Uzatma Kabloları Serisi
5951 1510	3 metre uzatma (3x1 mm)	50	20,40 ₺
5951 1520	5 metre uzatma (3x1 mm)	50	27,60 ₺
5951 1530	10 metre uzatma (3x1 mm)	25	53,00 ₺



### Delta

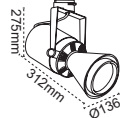

IP 40 ⊕

kod no	özellikler	koli adedi	fiyat
5816 1420	Beyaz Boş G-12	8	23,00 \$
5816 1542	35W Beyaz Elk. Bal. CDMT	8	38,00 \$
5816 1572	70W Beyaz Elk. Bal. CDMT	8	38,00 \$

### Gamma

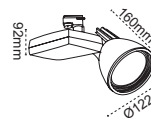

IP 40 ⊕

kod no	özellikler	koli adedi	fiyat
5816 1620	Beyaz Boş G-12	8	21,00 \$
5816 1742	35W Beyaz Elk. Bal. CDMT	8	36,00 \$
5816 1772	70W Beyaz Elk. Bal. CDMT	8	36,00 \$

### Alpha

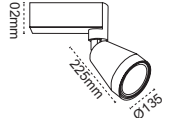

IP 40 ⊕

kod no	özellikler	koli adedi	fiyat
5816 1810	Beyaz Boş G-12	8	21,00 \$
5816 1932	35W Beyaz Elk. Bal. CDMT	8	36,00 \$
5816 1962	70W Beyaz Elk. Bal. CDMT	8	36,00 \$

### Cosmica

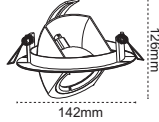

IP 40 ⊕

kod no	özellikler	koli adedi	fiyat
5816 3430	Cosmica Beyaz Boş GX5.3	50	4,15 \$

### Stella

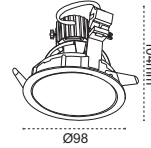

IP 40 ⊕

kod no	özellikler	koli adedi	fiyat
5816 3530	Beyaz Boş GX5.3	50	6,30 \$

### Piot 2

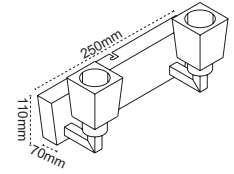

IP 40 ⊕

kod no	özellikler	koli adedi	fiyat
5812 3910	Piot 2 G9	12	16,00 \$

### Mare Beyaz Dikey Downlight

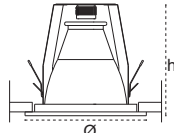

IP 40 ⊕

kod no	özellikler	koli adedi	fiyat
5512 7080	5" E27 PLE	20	3,50 \$
5512 7100	6" E27 PLE	20	4,50 \$

### Mare Beyaz Yatay Downlight

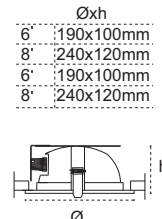

IP 40 ⊕

kod no	özellikler	koli adedi	fiyat
5512 7400	8" 2X26 Boş PLC	12	10,00 \$
5512 7160	6" 2XE27 PLE	20	10,00 \$

### Sarin Saten Dikey Downlight

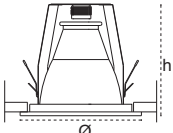

IP 40 ⊕

kod no	özellikler	koli adedi	fiyat
5512 9110	5" 2XE27 Camsız PLE	20	3,50 \$

### Dekart

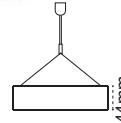

IP 40 ⊕

kod no	özellikler	koli adedi	fiyat
5610 1020	Dekart 2x28W T5Arm. Boş	1	300,00 ₺

### Menart

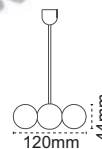

IP 40 ⊕

kod no	özellikler	koli adedi	fiyat
5610 5010	Menart 2x28W T5Arm. Boş	1	160,00 ₺

### Artemis

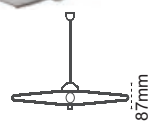

IP 40 ⊕

kod no	özellikler	koli adedi	fiyat
5610 2030	Artemis 3x35W Boş	1	300,00 ₺

**Polo**



Ø281  
131mm

IP 44

kod no	özellikler	koli adedi	fiyat
5730 5510	Polo 2 Aplik	0*	22,50 \$

**Arro**



220mm  
122mm

IP 40

kod no	özellikler	koli adedi	fiyat
5812 6610	Arro Rx7s	20	16,50 \$

**Perle**



272mm

IP 44

kod no	özellikler	koli adedi	fiyat
5730 9090	Perle Duvar Aplik	20	10,00 \$

**Duvar Gömme Çerçevesi**



234mm  
100mm  
72mm

IP 44

kod no	özellikler	koli adedi	fiyat
5730 9020	Duvar Gömme Çer. E27	18	4,60 \$

**Netled**



105mm  
105mm  
73mm

IP 40

kod no	özellikler	koli adedi	fiyat
5732 9320	Netled (Mavi)	20	11,50 \$

**Hatled**



105mm  
166mm  
166mm

IP 40

kod no	özellikler	koli adedi	fiyat
5732 9020	Hatled Mavi	12	14,00 \$

**Clupled**



Ø270  
75mm

IP 44

kod no	özellikler	koli adedi	fiyat
5732 5010	Clupled (Beyaz)	40	9,50 \$
5732 5070	Clupled (Ilık Beyaz)	40	9,50 \$
5732 5020	Clupled (Mavi)	40	9,50 \$

**İşiled**



141mm  
60mm  
65mm

IP 44

kod no	özellikler	koli adedi	fiyat
5732 4020	İşiled Mavi	24	12,00 \$
5732 4070	İşiled (Ilık Beyaz)	24	12,00 \$

**İşiled 3**



60mm  
65mm  
141mm

IP 44

kod no	özellikler	koli adedi	fiyat
5732 4220	İşiled 3 Mavi	24	12,00 \$

**Eko Halojen**



Ø36  
99mm

kod no	özellikler	koli adedi	fiyat
5983 2280	Maxin 42W E14 2700K	100	0,60 \$

**PLC Lamba**



27mm  
154mm

kod no	özellikler	koli adedi	fiyat
5980 1540	Maxin 26W PLC 4000K	100	1,00 \$

**Gece Lamba**



kod no	özellikler	koli adedi	fiyat
5982 4030	5W E-27 Mantar Tipi Yeşil	100	0,28 \$
5982 4040	5W E-27 Mantar Tipi Mavi	100	0,28 \$

### 75W Cob Projektör

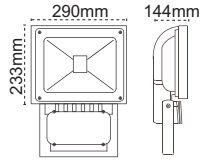

IP 66

kod no	özellikler	koli adedi	fiyat
5617 1321	75W 6500K	1	50,00 \$

### 30W Cob Projektör

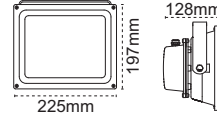

IP 44

kod no	özellikler	koli adedi	fiyat
5615 6790	30W Yeşil	1	22,00 \$

### Levo Projektör

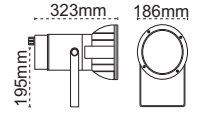

IP 44

kod no	özellikler	koli adedi	fiyat
5321 1710	70W G12 MH/SB Boş	1	58,75 \$

### Krono

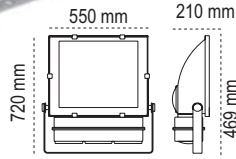
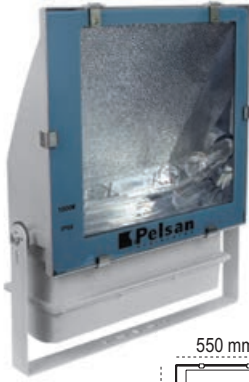

IP 44

kod no	özellikler	koli adedi	fiyat
5611 2611	1000W KRONO	1	350,00 \$

### Shekelo Projektör

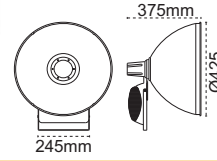

IP 65

kod no	özellikler	koli adedi	fiyat
5611 3811	250W E40 MH/SB Boş	1	180,00 \$

### Tünel Armatürü

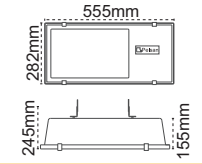

IP 65

kod no	özellikler	koli adedi	fiyat
5322 1011	250 W Sodyum E40	1	130,00 \$
5322 1012	400 W Sodyum E40	1	138,00 \$

### Rimo

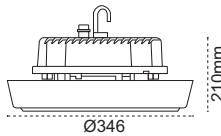

IP65

kod no	özellikler	koli adedi	fiyat
5616 2771	3X26W COB Ledli 5000K	1	150,00 \$

### Fuga

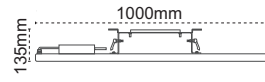

IP 65

kod no	özellikler	koli adedi	fiyat
5616 4511	Fuga 22W Ledli 3000K	1	199,00 \$

### Sensörlü Aplik

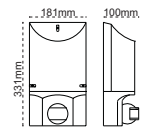

IP 44

kod no	özellikler	koli adedi	fiyat
5413 2060	Sensörlü Aplik	1	15,00 \$







# ATEX Belgesi

**IEP ENERGY PETROLEUM INSTITUTE** **IEP ATEX**

(1) **EU- Internal Production Control Certificate**

(2) **Equipment or Protective Systems Intended for use in Potentially Explosive Atmospheres**

Directive 2014/34/EU

(3) EU - Internal Production Control Certificate Number: IEP 16 ATEX 0468

(4) Product: **Led lighting fixtures, Pelsan xy series**

(5) Firm Name: **PELSAN AYDINLATMA SANAYİ VE TİCARET A.Ş.**

(6) Firm Address: **İmes Sanayi Sitesi A Blok 101 Sokak No:38 Dudulla Ümraniye - İSTANBUL, TURKEY**

(7) This product any of acceptable variation thereto is specified in the schedule to this certificate and the documents therein referred to.

(8) The IEP Uluslararası Enerji Petrol Gazıtın, Sertifikasyon ve Teknik Hizmetler Organizasyonu Tic. Ltd. Sti., notified body number 2284 in accordance with Article 17 of the Directive 2014/34/EU of European Parliament and of the Council, dated 26 February 2014, certifies that this product has been found to comply with the Essential Health and Safety Requirements relating to the design and construction of products intended for use in potentially explosive atmospheres, given in Annex B/VIII to the Directive. The examination and test results are recorded in confidential Report Nr: IEP.Rp.Ex.10-1037 date 18.11.2016.

(9) Compliance with Essential Health and safety requirements has been assured by compliance with:  
**EN 60079-0 : 2012, EN 60079-15 : 2010, EN 60079-31 : 2009**

(10) If the sign "X" is placed after the certificate number, it indicates that the product is subject to Specified Conditions of Safe Use specified in the schedule to this certificate.

(11) This EU-Internal Production Control Certificate relates only to the design and construction of the specified product in accordance to the directive 2014/34/EU. Further requirements of the directive apply to the manufacturing process and supply of this product. These are not covered by this certificate. Validity date 10 year. If standard or product change, this certificate is invalid.

(12) The marking of the equipment or protective system shall include the following:

**II 3G Ex nR IIC T5 Gc**  
**II 3D Ex tc IIC (T 95 °C) Dc**

Responsible Person :  
Nurgün Terzioğlu  
Head of Certification Body

Date of Issue : **22.11.2016**

IEP Uluslararası Enerji Petrol Gazıtın, Sertifikasyon ve Teknik Hizmetler Organizasyonu Tic. Ltd. Sti.  
37461 Sok. No:9 K.2 Beşiktaş - İZMİR - TÜRKİYE  
Tel : +90 232 431 17 45 - 46 Fax : +90 232 431 17 30 E-mail: info@iep.com.tr Fr:65  
This certificate is granted subject to the general conditions of the IEP Energy Petroleum Institute. This certificate may only be reproduced in its entirety and without any change, schedule included. You can check accuracy of this document by www.iep.com.tr  
Page | 1 / 2

**IEP ENERGY PETROLEUM INSTITUTE**

(13) Schedule

(14) Certificate Nr: **IEP 16 ATEX 0468**

(15) Description of Equipment Protective System:

The Led lighting fixtures, Pelsan xy series designed as an floodlights, high bay and canopy are mounting type of electrical device. Led lighting fixtures, Pelsan xy series made from according to Aluminum. Led lighting fixtures, Pelsan xy series is equipped with cable gland d or e type. To must be used of ground cable 4 mm<sup>2</sup> (min) and 11P.

**Technical Parameters: Led lighting fixtures, Pelsan xy series**

Type	Power ( W )
Piriliz	50, 75, 100, 125, 150
Sia	50, 75, 100, 125, 150
Nairo	50, 75, 100, 125, 150

**Operating Voltage 230 V AC , 50 / 60 Hz.**  
**Operating Temperature ( -20 ~ +50 ) °C**

**Led lighting fixtures Product Code System**

Pelsan X Y  
Power (50, 75, 100, 125, 150)  
Model; Piriliz , Sia, Nairo (Accessory)  
Mark

(16) This certificate is in the contents of standards that mentioned in item [ 9 ] It has been accepted that Led lighting fixtures is manufactured according to the producer instructions and the standards mentioned above.

(17) Information's of mounting instruction manual of 4 pages approved and date 08.02.2016.

(18) List of Documentation:

Drawing Nr :	Drawing Name :	Date :
PLS-01	Frame	25.01.2016
PLS-02	Body Aluminum	25.01.2016
PLS-03	Plastic Driver Cover	25.01.2016
PLS-04	Screw Cross Section	25.01.2016
PLS-05	Exploded Drawing	25.01.2016
PLS-06	Assembly	25.01.2016
PLS-07	Plastic Reflector	25.01.2016
PLS-08	Roof Connection	25.01.2016

Part inside of Led lighting fixtures, Pelsan xy series indicated in the part list and equipment list, table 1 dated 08.02.2016.

Responsible Person:  
Nurgün Terzioğlu  
Head of Certification Body

Date of Issue : **22.11.2016**

IEP Uluslararası Enerji Petrol Gazıtın, Sertifikasyon ve Teknik Hizmetler Organizasyonu Tic. Ltd. Sti.  
37461 Sok. No:9 K.2 Beşiktaş - İZMİR - TÜRKİYE Tel : +90 232 431 17 45 - 46 Fax : +90 232 431 17 30 E-mail: info@iep.com.tr Fr:65  
This certificate is granted subject to the general conditions of the IEP Energy Petroleum Institute. This certificate may only be reproduced in its entirety and without any change, schedule included. You can check accuracy of this document by www.iep.com.tr  
Page | 2 / 2

ATEX Belgeli Pelsan Exproof armatürler, tehlikeli gaz ve toz maddelerinin bulunduğu, patlama riski yüksek olan ortamlarda güvenle kullanılabilir.

## Türk Akreditasyon Sertifikası

**TÜRKAK TÜRK AKREDİTASYON KURUMU**

**AKREDİTASYON SERTİFİKASI**

Deney Laboratuvarı olarak faaliyet gösteren,

**PELSAN AYDINLATMA SANAYİ VE TİCARET A.Ş.**  
**Pelsan Aydınlatma Laboratuvarı**  
Emek Mah. Nato Yolu Cad. No:280 Sancaktepe  
34785 İSTANBUL / TÜRKİYE

TÜRKAK tarafından yapılan denetim sonucunda TS EN ISO/IEC 17025:2012 Standardına göre Ek'te yer alan kapsamlarda akredite edilmiştir.

**Akreditasyon No : AB-0795-T**  
**Akreditasyon Tarihi : 28 Nisan 2015**

Bu Sertifika, yukarıda açık adı ve adresi yazılı Kuruluşun TS EN ISO/IEC 17025:2012 Standardına, ilgili Yönetmelik ve Tebliğlere uygunluğunu sürdürmesi halinde, **27 Nisan 2019** tarihine kadar geçerlidir.

**Dr. H. İbrahim ÇETİN**  
Genel Sekreter

Türk Akreditasyon Kurumu tarafından akredite olan laboratuvarımız ile tüm aydınlatma ürünlerini belgelendiriyoruz.

# Yılın Aydınlatma Firması Pelsan



"Pelsan Aydınlatma olarak "Yılın Aydınlatma Firması Anketi"ni değerli destekçilerimizin oylarıyla 1. sırada tamamladık. Aydınlatma Portalı tarafından düzenlenen "Yılın Aydınlatma Firması" anketinde, firmamızı oylarıyla destekleyen herkese teşekkür eder, ankette bizimle birlikte yarışmış tüm rakiplerimize başarılı bir yeni yıl dileriz."

[www.pelsan.com.tr](http://www.pelsan.com.tr)

**GENEL MERKEZ**

İmes Sanayi Sitesi  
A Blok 101 Sk No.38  
Y. Dudullu / İstanbul  
Tel.: (0850) 460 75 76  
Faks: (0216) 364 60 15

**FABRİKA**

Çerkeşli OSB İmes  
5. Cadde No.12  
Dilovası / Kocaeli  
Tel.: (0850) 460 75 76  
Faks: (0216) 364 60 15

**KARAKÖY MERKEZ**

Emekyemez Mah.  
Yanıkkapı Porsuk Sk  
No. 11 Karaköy / İstanbul  
Tel.: (0850) 460 75 76  
Faks: (0216) 364 60 15

**PERPA BÖLGE OFİSİ**

Perpa Ticaret Merkezi  
A Blok Kat: 9 No.1178  
Okmeydanı / İstanbul  
Tel.: (0850) 460 75 76  
Faks: (0216) 364 60 15

Fiyatlara KDV dahil değildir. Pelsan Aydınlatma gerekli koşullarda fiyat ve ürün değiştirme hakkını saklı tutar.