

Paket Şalter Serisi / Rotary Cam Switch Series



*40 yıldır Kalite ve Güvenle...
Quality and Confidence for 40 years...*

METOP®

ELEKTRİK SANAYİ VE TİCARET LTD. ŞTİ

Sayın Müşterilerimiz, Değerli İş Ortaklarımız,

Kurulduğu günden bugüne kadar kalite ve güvenden ödün vermeyen firmamız, topluma, çalışanlarına ve çevreye karşı sorumluluklarını tam anlamı ile idrak etmiştir.

Uluslararası standartlarda ve normlarda ürün ve hizmet kalitesini sürdürmeyi hedeflemektedir.

Sürekli kalite ve müşteri memnuniyetini uygulamak ve sağlamak için hiçbir maliyetten ve yatırımdan kaçınmayarak, yıllar boyu güvenle kullanabileceğiniz ürünleri üretmeye devam etmektedir.

Elektroteknik pazarında tamamiyle yerli teknoloji ve sermaye ile var olan firmamız taşıdığı sorumluluğun bilincinde olmakla birlikte aynı zamanda uluslararası pazarlarda da yerini korumaktadır.

Dear Customers and Businesspartners,

Since Metop has established, never makes any concessions from quality and reliability and attained in real meaning of the responsibility to society, dependents and environment.

The aim and goal of Metop is to keep the product and customer service quality on international standards and normatives.

Metop never spare of any expense or investment for consistent quality and customer satisfaction and continue to produce the products which can be used over years with safe and trust.

Metop has completely domestic technology and capital which keeps also its place in the international markets

40 yıldır Kalite ve Güvenle...
Quality and Confidence for 40 years...

El Kumandaları /Renk Kodu
Handles / Colour Codes

Referans
Reference

Referansa ait
Boyutlar
Corresponding
Sizes



M

M1
M2
M3



MG

M3



MC

M2
M3



PP

M3
M4



PG

M4

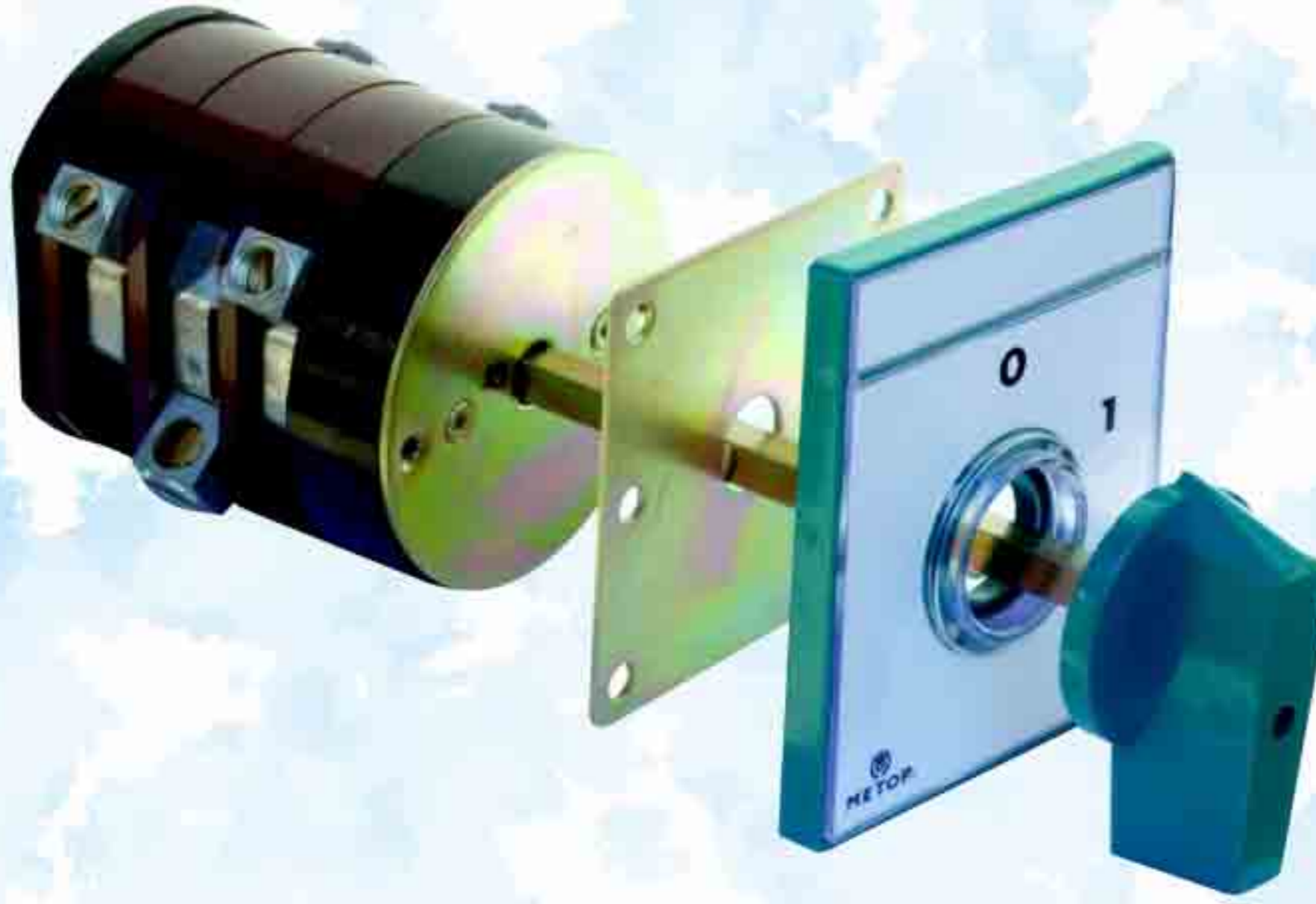

**PAKET ŞALTERLERİN TEKNİK KARAKTERİSTİKLERİ
TECHNICAL CHARACTERISTICS OF ROTARY CAM SWITCHES**

BOYUTLAR/SIZES			M1				M2		M3		M4	
			10A	16A	25 A	32 A	40 A	63 A	100 A	125 A	160 A	200 A
Yalıtım gerilimi/Nominal insulation tension	V		660	660	660	660	660	660	660	660	660	660
Nominal akım/Nominal current I _e	A		10	16	25	32	50	63	100	125	160	200
Nominal ısı akımı/Nominal thermal current I _{th}	A		16	20	32	40	63	75	125	160	200	250
Sigorta akımı/Fuse current (I _n 10 kA)	A		32	50	63	80	80	100	125	160	200	250
		(I _n 40 kA)	A	32	50	63	80	100	125	160	200	200
AC1 - AC21 * Dirençli devreler /Resistant circuits												
3 x 220 V~	kW		5.2	5.2	10.5	10.5	11	14	29	33	37	50
3 X 380 V~	kW		6	9	15	18	19	24	50	59	63	80
3 x 500 V~	kW		9	11.8	17	20	23	33	66	79	84	120
3 x 660 V~	kW		11	15.5	22	27	30	43	86	100	110	185
AC3 - AC23* Üç fazlı motorlar/Three phase motors												
3 x 220 V~	kW		1.5	3	5.5	9	10	12.5	21	25	27	28
3 x 380 V~	kW		1.6	5	11	16	17	21	37	40	45	47
3 x 500 V~	kW		4	6	11	17	18	27	48	59	62	65
3 x 660 V~	kW		5	6	13	17	18	27	60	75	80	80
AC3 - AC23* Bir fazlı motorlar/Singlephase motors												
110V~	kW		0.8	1.2	1.3	2.5	2.2	5.3				
220 V~	kW		1.7	2	2.6	4	4.4	10				
380 V~	kW ²		2.8	3.2	4.6	5.5	7.5	17				
Mekanik ömür/Mechanical life			3x10 ⁶	3x10 ⁶	3x10 ⁶	3x10 ⁶	3x10 ⁶	1x10 ⁶	2x10 ⁵	2x10 ⁵	2x10 ⁵	2x10 ⁵
Terminal civata ebatları/Terminal bolt size			M3	M4	M4	M5	M5	M6	M10	M8	M8	M10
İletken kesiti/Conductor cross section	mm		1/1.5	1.5/2.5	1.5/2.5	4/6	4/6	10/16	16/25	25/35	35/50	50/70
	AWG		18	18	18	12	12	10	8	6	Embouts	Jeux de barres
Nominal kesme kapasitesi/Nominal cut-off capacity (10 I _e x 1,1 U _e)	110 V~	VA	13.000	20.000	24.000	29.000	40.000	76.000				
	220 V~	VA	15.000	40.000	48.000	50.000	53.000	130.000				
	380 V~	VA	14.000	50.000	66.000	80.000	82.000	180.000				
	660 V~	VA	17.000	51.000	58.000	60.000	61.000	72.000				
Ortam sıcaklığı/Ambient temperature	°C		-25... +50									
Koruma sınıfı(Ön panel)/Protection category (Front plate)			IP55									
Standartlar/Standards			IEC 94		EN 60947-3		VDE0660		TS EN 60947-3			

*(30 on - off / h)

AC 1 : Endüktif olmayan yükler/Noninductive charges.

AC 3 : Sincap kafesli asenkron motorlar/Squirrelcage asynchronous induction motors.

AC 21 : Omik yükler/Ohmic charges.

AC 23 : Yüksek endüktif yük ve motorları/High inductive charges and motors

MT015 1 Fazlı Aç Kapa Şalter
1-Pole On-Off Switch



Anma akımı Rated current	Boyut Size	Kutu Ebatları/Box Sizes W x L x H (mm)
10 A	M1	47x57x63
16A	M2	63x78x74
25A	M2	63x78x74
32A	M3	119x92x112
40A	M3	119x92x112
63A	M3	119x92x112
100A	M3	119x92x112
125A	M3	119x92x112
160A	M3	119x92x112
200A	M3	119x92x112

MT017 2 Fazlı Aç Kapa Şalter
2-Poles On-Off Switch

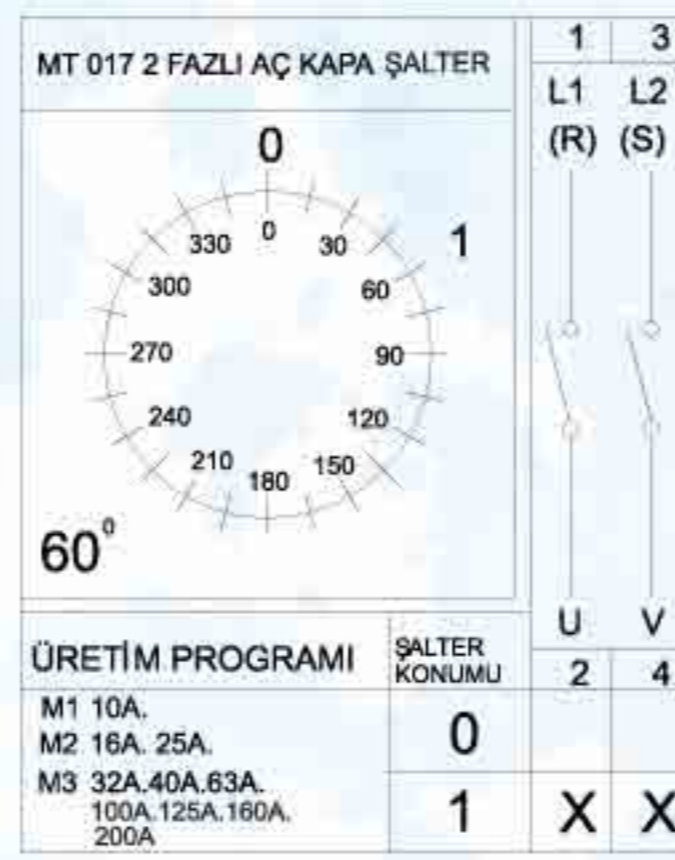
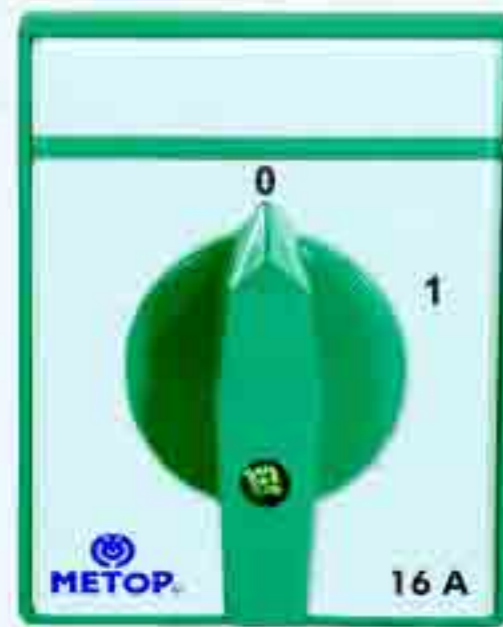

Anma akımı Rated current	Boyut Size	Kutu Ebatları/Box Sizes W x L x H (mm)
10 A	M1	47x57x63
16 A	M2	63x78x74
25 A	M2	63x78x74
32 A	M3	119x92x112
40 A	M3	119x92x112
63 A	M3	119x92x112
100 A	M3	119x92x112
125 A	M3	119x92x112
160 A	M3	134x92x112
200 A	M3	153x104x109

MT019 3 Fazlı Aç Kapa Şalter
3-Poles On-Off Switch

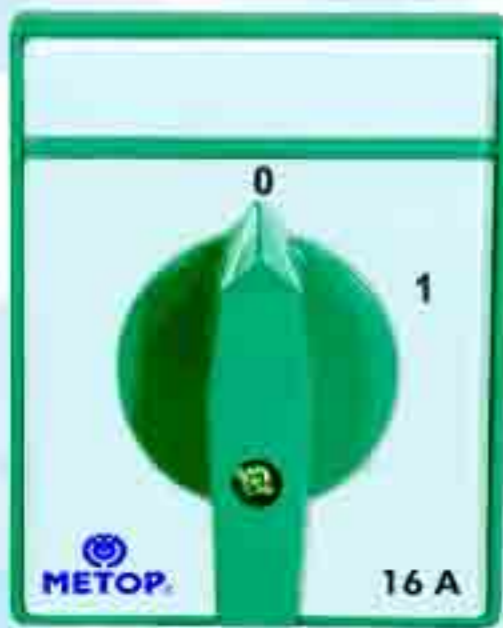

Anma akımı Rated current	Boyut Size	Kutu Ebatları/Box Sizes W x L x H (mm)
10 A	M1	47x57x76
16A	M2	63x78x90
25A	M2	63x78x90
32A	M3	119x92x112
40A	M3	119x92x112
63A	M3	119x92x112
100A	M3	134x92x112
125A	M3	153x104x109
160A	M3	185x110x112
200A	M3	211x108x112

MT020 3 Fazlı Nötrlü Aç Kapa Şalter
3-Poles +N On-Off Switch

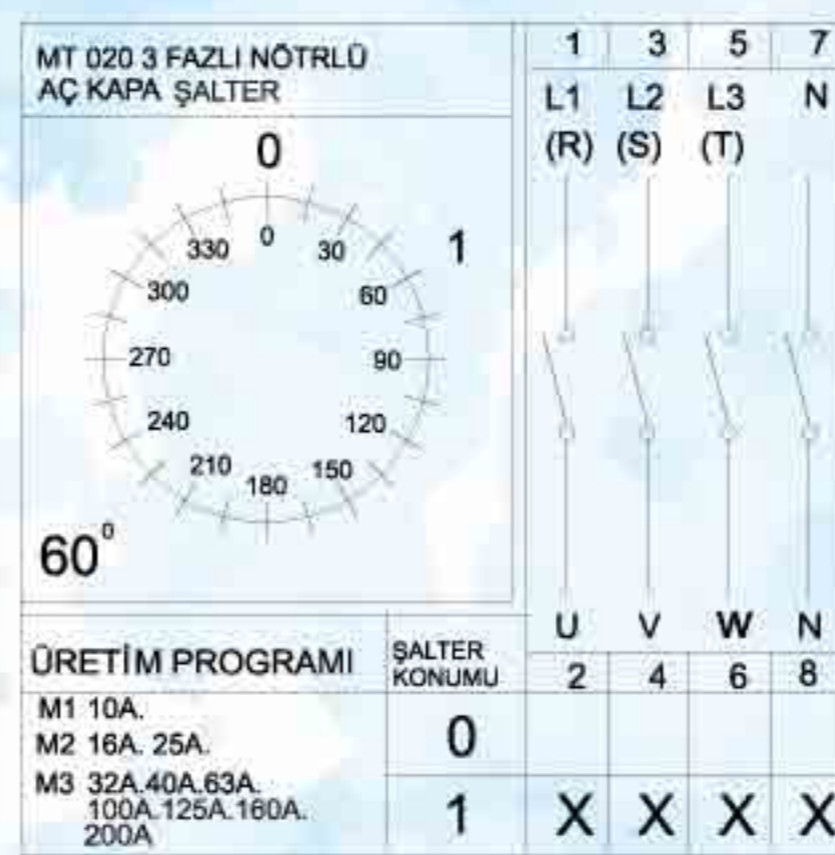
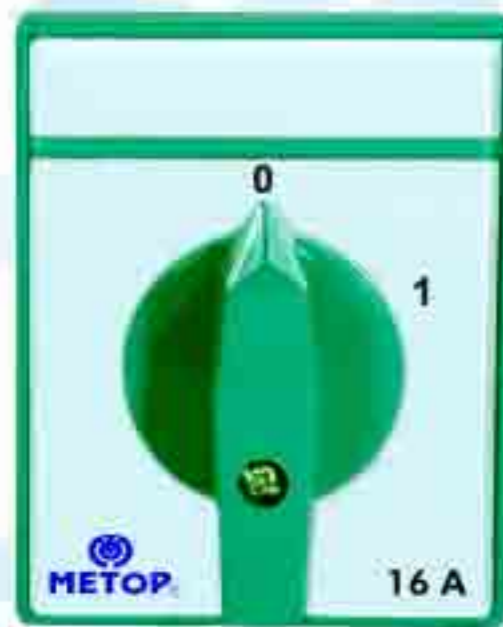

Anma akımı Rated current	Boyut Size	Kutu Ebatları/Box Sizes W x L x H (mm)
10 A	M1	47x57x76
16A	M2	63x78x90
25A	M2	63x78x90
32A	M3	119x92x112
40A	M3	119x92x112
63A	M3	119x92x112
100A	M3	160x102x107
125A	M3	160x102x107
200A	M3	240x120x112

MT037 Daimi Döner 1 Fazlı Aç Kapa Şalter
1-Pole On-Off Rotating Switch

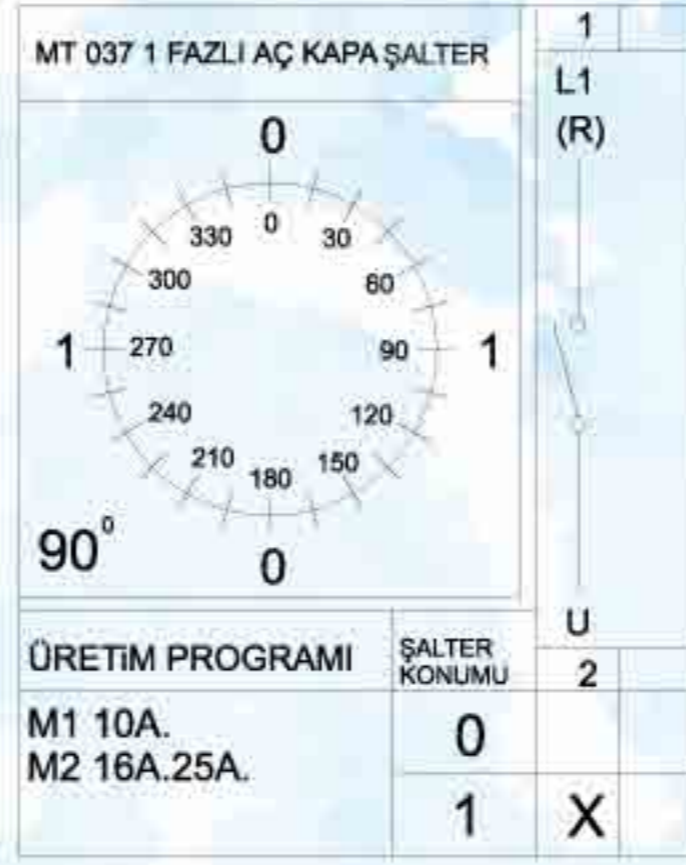

Anma akımı Rated current	Boyut Size	Kutu Ebatları/Box Sizes W x L x H (mm)
10 A	M1	47 x 57 x 63
16 A	M2	63 x 78 x 74
25 A	M2	63 x 78 x 74

MT038 Daimi Döner 2 Fazlı Aç Kapa Şalter
2-Poles On-Off Rotating Switch

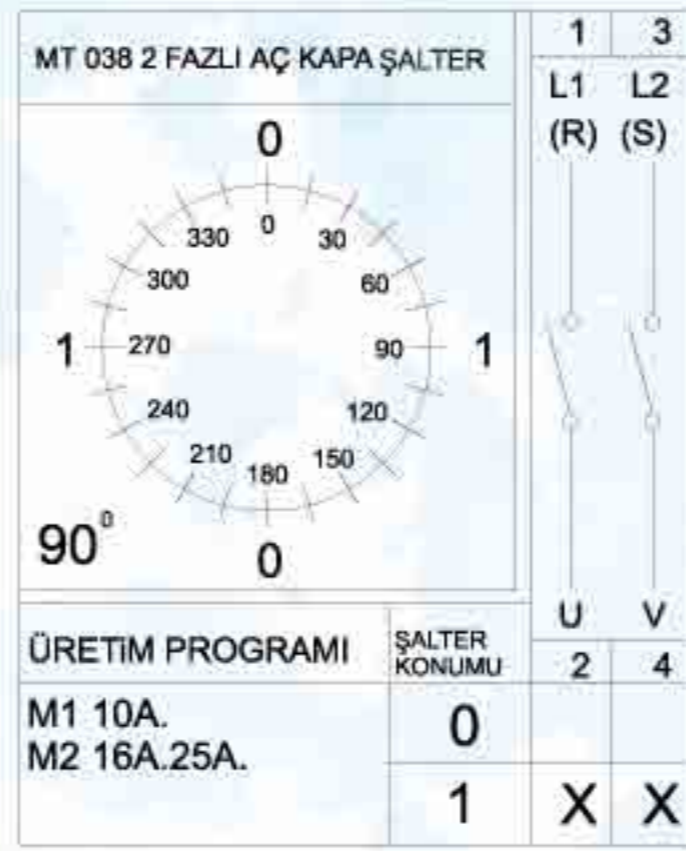

Anma akımı Rated current	Boyut Size	Kutu Ebatları/Box Sizes W x L x H (mm)
10 A	M1	47 x 57 x 76
16 A	M2	63 x 78 x 90
25 A	M2	63 x 78 x 90

MT039 Daimi Döner 3 Fazlı Aç Kapa Şalter
3- Poles On-Off Rotating Switch

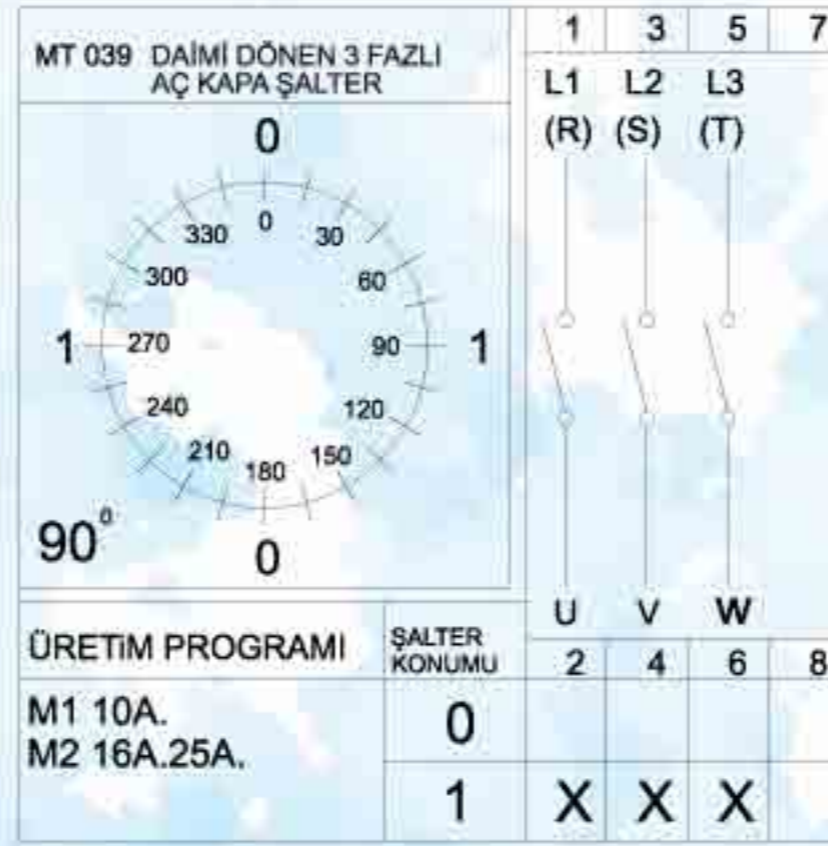

Anma akımı Rated current	Boyut Size	Kutu Ebatları/Box Sizes W x L x H (mm)
10 A	M1	47 x 57 x 76
16 A	M2	63 x 78 x 90
25 A	M2	63 x 78 x 90

MT082 3 Fazlı Aç-Kapa Emniyet Şalteri
(Kilitlenebilir)
3-Poles Safety On-Off Switch
(Lockable)

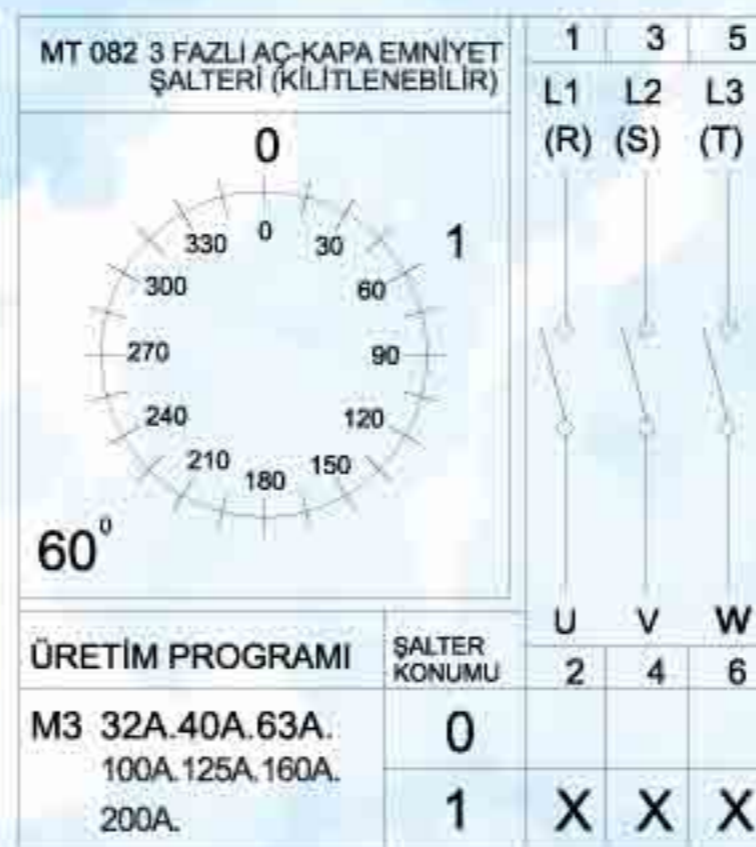

Anma akımı Rated current	Boyut Size	Kutu Ebatları/Box Sizes W x L x H (mm)
32 A	M3	119x92x112
40 A	M3	119x92x112
63 A	M3	119x92x112
100 A	M3	134x92x112
125 A	M3	153x10x109
160 A	M3	185x110x112
200 A	M3	211x108x112

MT027 1 Fazlı Kutup Değiştirici Şalter
1-Pole Changeover Switch



*0'sız tipi de vardır.Exists also without "0" position



Anma akımı Rated current	Boyut Size	Kutu Ebatları/Box Sizes W x L x H (mm)
10 A	M 1	47x57x63
16 A	M 2	63x78x74
25 A	M 2	63x78x74
32 A	M 3	119x92x112
40 A	M 3	119x92x112
63 A	M 3	119x92x112
100 A	M 3	134x92x112
125 A	M 3	134x92x112

MT028 2 Fazlı Kutup Değiştirici Şalter
2-Poles Changeover Switch

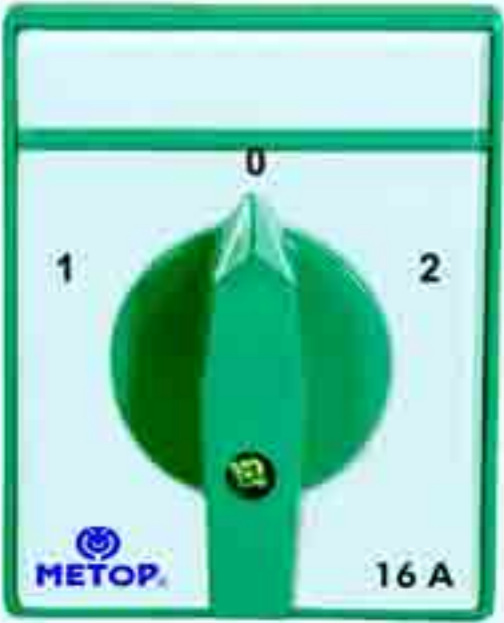

*0'sız tipi de vardır.Exists also without "0" position

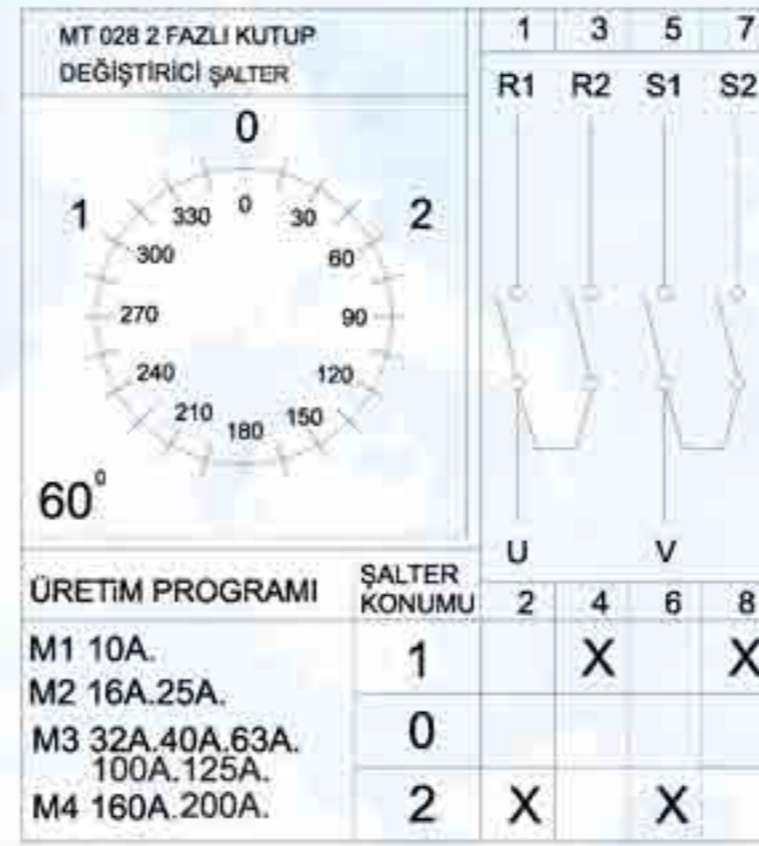

Anma akımı Rated current	Boyut Size	Kutu Ebatları/Box Sizes W x L x H (mm)
10 A	M 1	47x57x76
16 A	M 2	63x78x90
25 A	M 2	63x78x90
32 A	M 3	119x92x112
40 A	M 3	119x92x112
63 A	M 3	119x92x112
100 A	M 3	153x104x109
125 A	M 3	153x104x109

MT029 3 Fazlı Kutup Değiştirici Şalter
(Jenarator Şalteri)
3-Poles Changeover Switch
(Generator Switch)

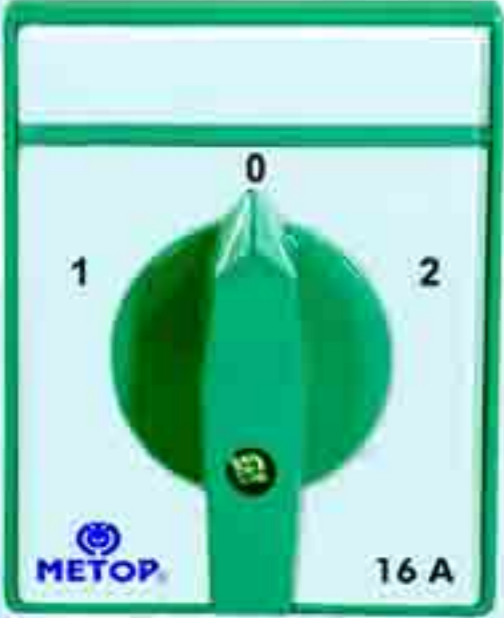

*0'sız tipi de vardır.Exists also without "0" position

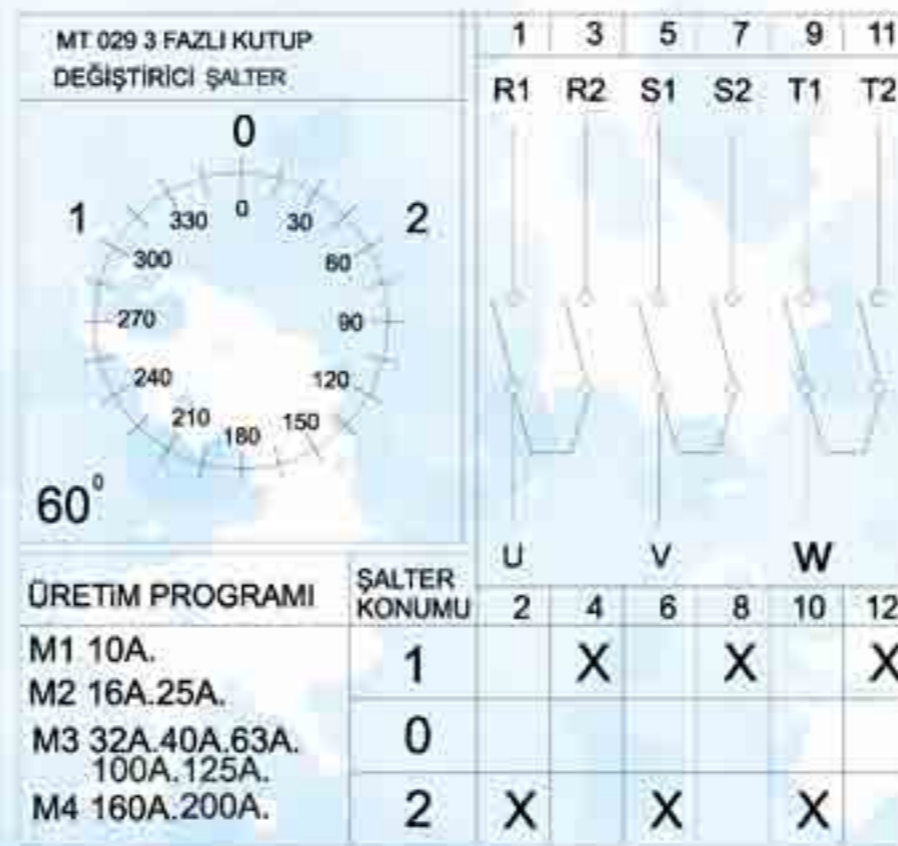

Anma akımı Rated current	Boyut Size	Kutu Ebatları/Box Sizes W x L x H (mm)
10 A	M 1	47x57x89
16 A	M 2	63x78x106
25 A	M 2	63x78x106
32 A	M 3	134x92x112
40 A	M 3	134x92x112
63 A	M 3	134x92x112
100 A	M 3	210x112x112
125 A	M 3	210x112x112

MT057 3 Fazlı Nötrlü Kutup Değiştirici Şalter
3-Poles +N Changeover Switch



*0'sız tipi de vardır.Exists also without "0" position

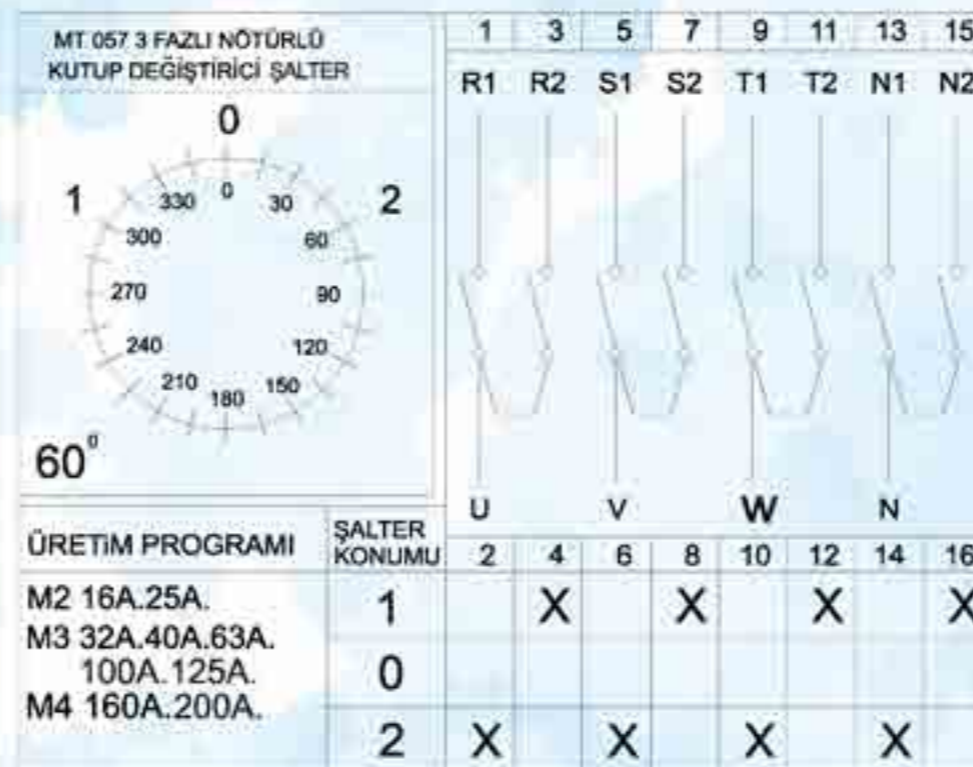

Anma akımı Rated current	Boyut Size	Kutu Ebatları/Box Sizes W x L x H (mm)
16 A	M 2	126x98x68
25 A	M 2	126x98x68
32 A	M 3	160x92x112
40 A	M 3	160x92x112
63 A	M 3	160x92x112

MT056 6 Fazlı Kutup Değiştirici Şalter
6-Poles Changeover Switch

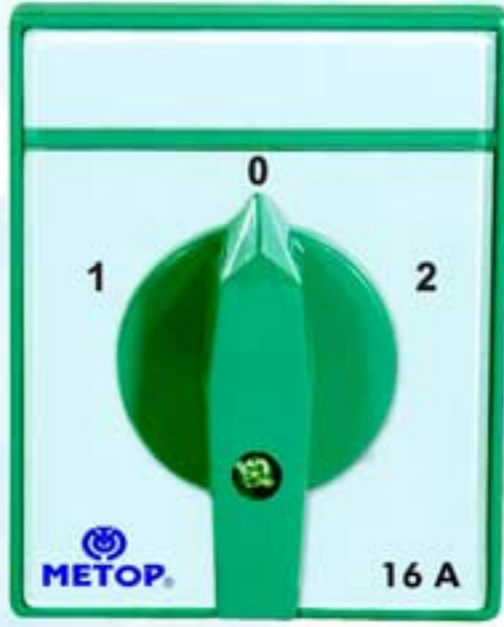

*0'sız tipi de vardır.Exists also without "0" position

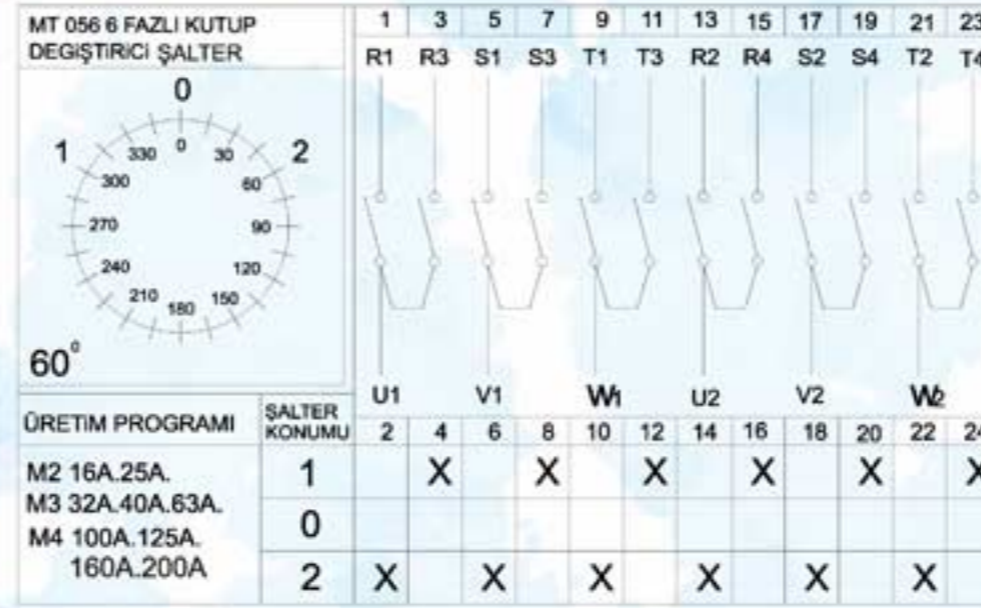

Anma akımı Rated current	Boyut Size	Kutu Ebatları/Box Sizes W x L x H (mm)
16 A	M 2	185x78x68
25 A	M 2	185x78x68
32 A	M 3	210x112x112
40 A	M 3	210x112x112
63 A	M 3	210x112x112

MT021 3 Fazlı Enversör (Sağ Sol) Şalter
3-Poles Motor Reversing Switch (Right-Left)

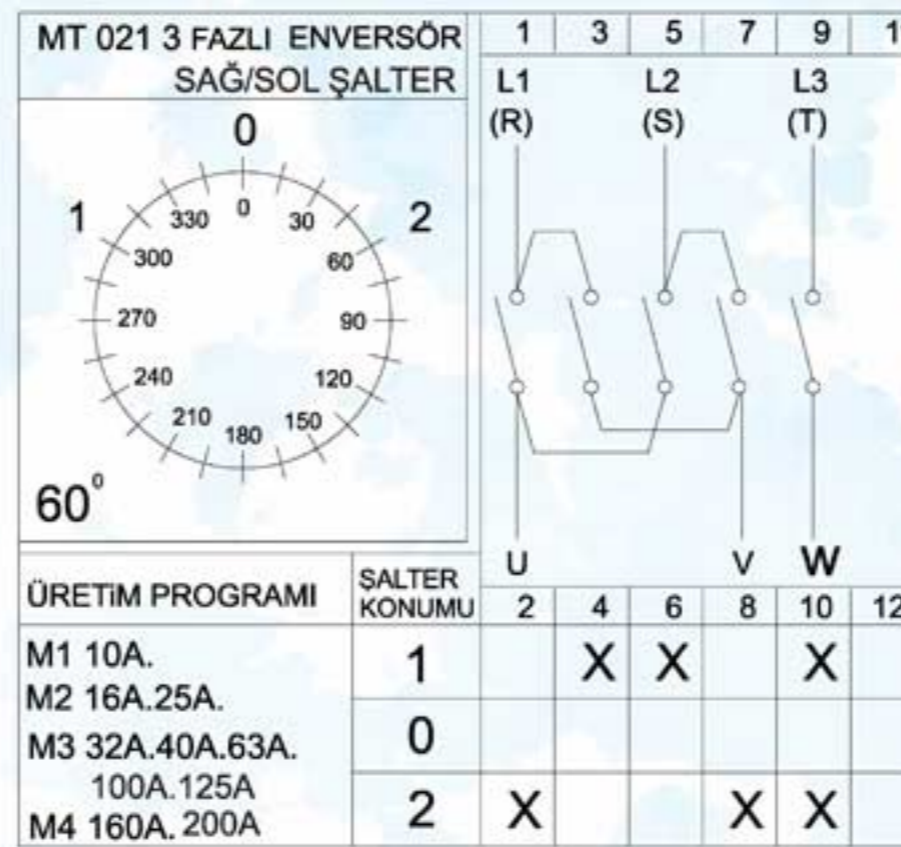
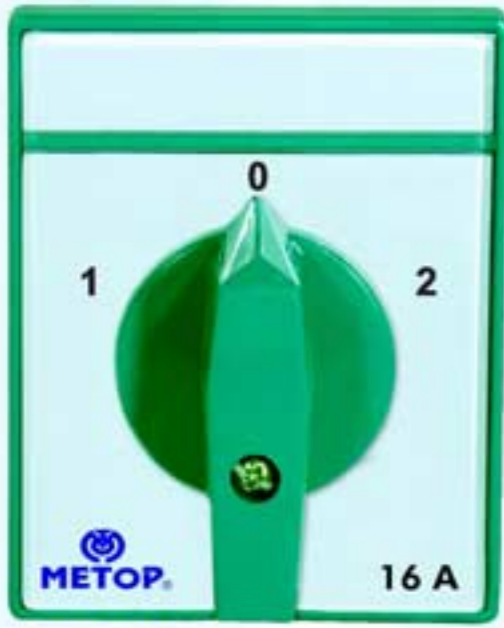

Anma akımı Rated current	Boyut Size	Kutu Ebatları/Box Sizes W x L x H (mm)
10 A	M 1	47x57x89
16 A	M 2	63x78x106
25 A	M 2	63x78x106
32 A	M 3	134x92x112
40 A	M 3	134x92x112
63 A	M 3	134x92x112
100 A	M 3	212x108x112
125 A	M 3	212x108x112

MT080 1 Fazlı Enversör (Sağ Sol) Şalter
Single Pole Motor Reversing Switch, (Right-Left)

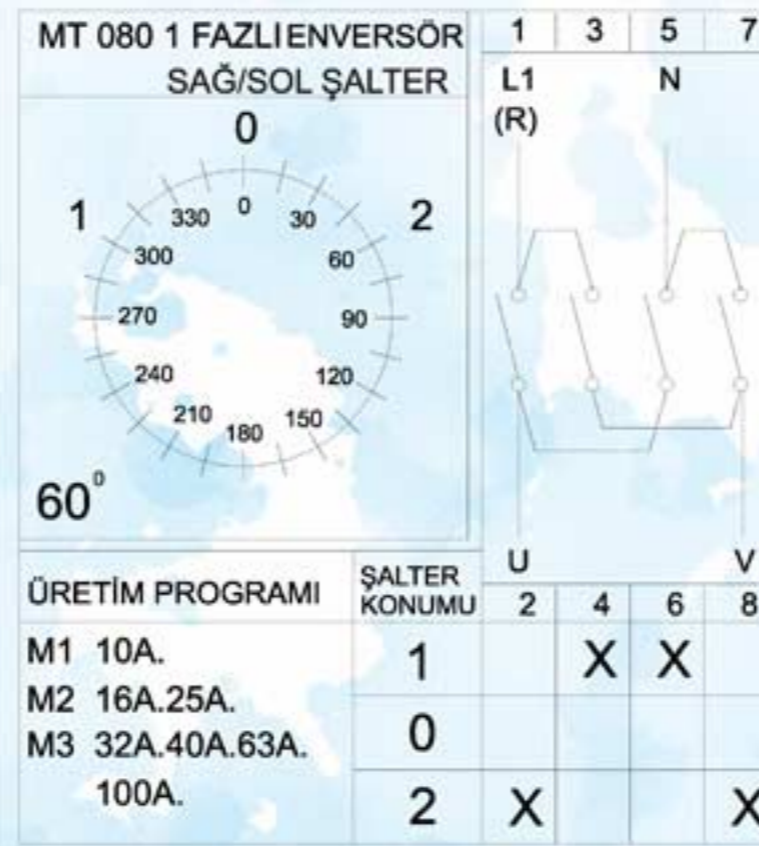

Anma akımı Rated current	Boyut Size	Kutu Ebatları/Box Sizes W x L x H (mm)
10 A	M 1	47 x 57 x 63
16 A	M 2	63 x 78 x 90
25 A	M 2	63 x 78 x 90
32 A	M 3	119 x 92 x 112
40 A	M 3	119 x 92 x 112
63 A	M 3	119 x 92 x 112
100 A	M 3	119 x 92 x 112

MT081 1 Fazlı Yardımcı Sargılı Enversör (Sağ Sol) Şalter
1-Pole Motor Reversing Switch (Right-Left) with Auxillary Winding

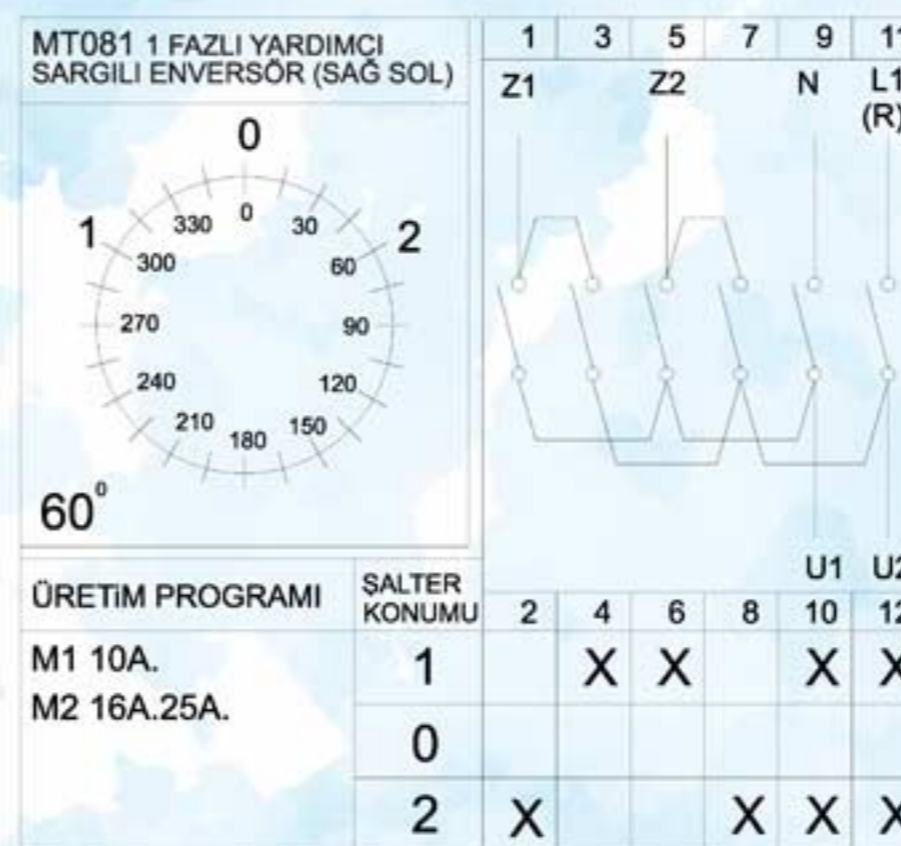

Anma akımı Rated current	Boyut Size	Kutu Ebatları/Box Sizes W x L x H (mm)
10 A	M 1	55 x 42 x 74
16 A	M 2	76 x 60 x 90
25 A	M 2	76 x 60 x 90

MT031 Yıldız Üçgen Şalter
Star Delta Motor Starting Switch,
Single Speed, Single Direction

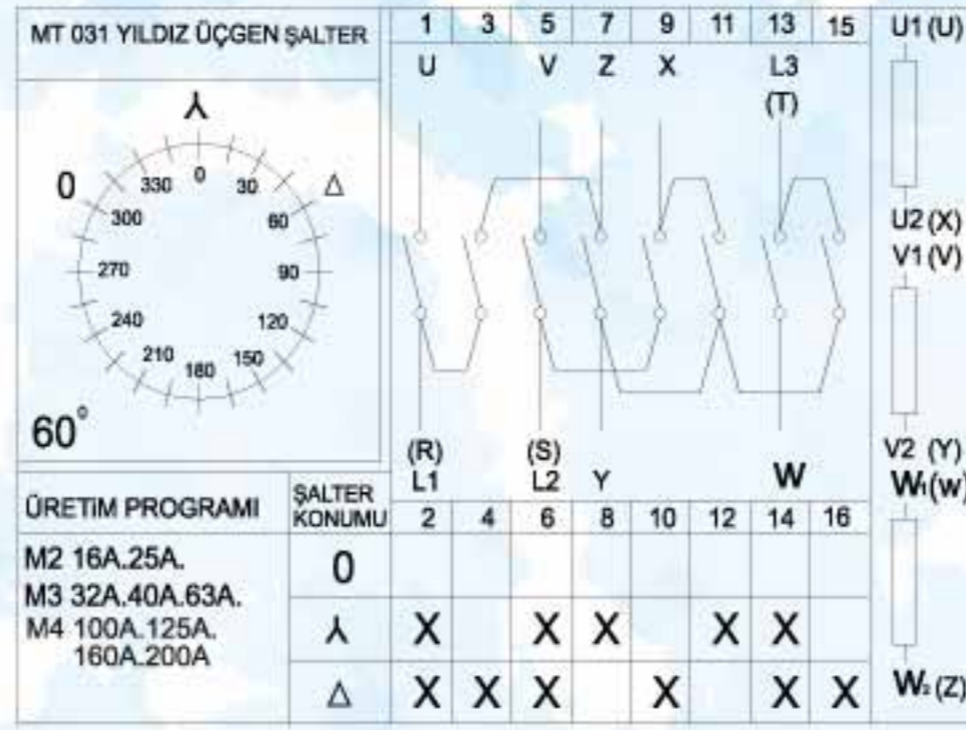
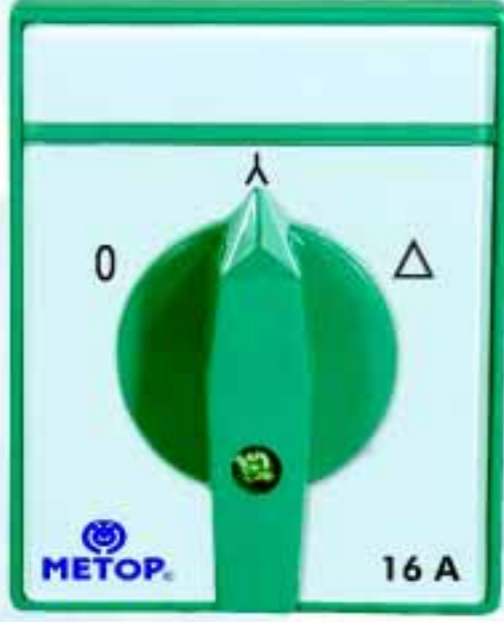

Anma akımı Rated current	Boyut Size	Kutu Ebatları/Box Sizes W x L x H (mm)
16 A	M2	63 x 78 x 121
25 A	M2	63 x 78 x 121
32 A	M3	160 x 92 x 112
40 A	M3	160 x 92 x 112
63 A	M3	160 x 92 x 112

MT054 Çift Devirli Motor Şalteri (Dahlender)
Double Speed Motor Switch
(Seperate Windings) (1-0-2)Dahlender

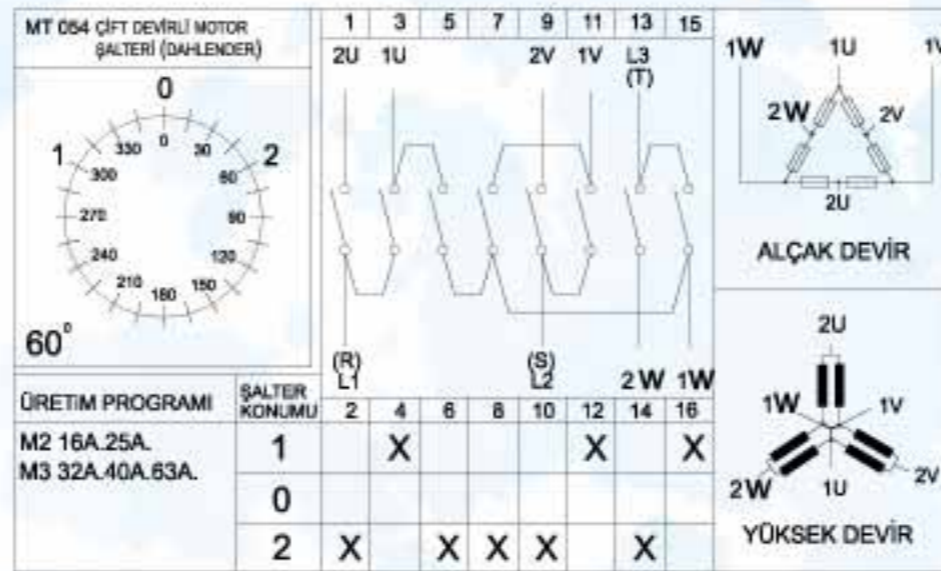
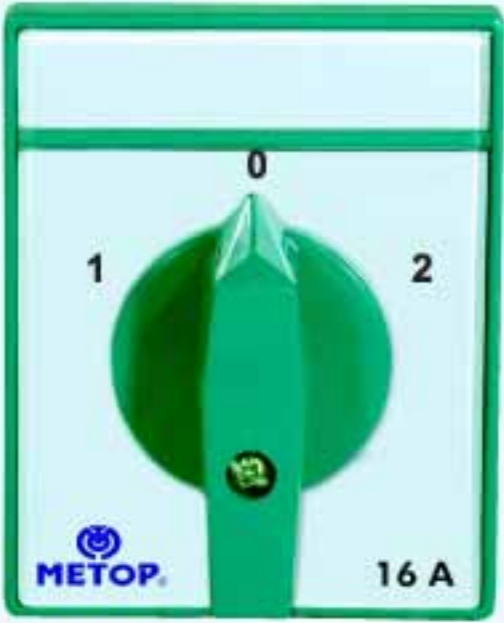

Anma akımı Rated current	Boyut Size	Kutu Ebatları/Box Sizes W x L x H (mm)
16 A	M2	196 x 78 x 68
25 A	M2	196 x 78 x 68
32 A	M3	265 x 108 x 90
40 A	M3	265 x 108 x 90
63 A	M3	265 x 108 x 90

MT1197 Çift Devirli Motor Şalteri (Dahlender)
Double Speed Motor Switch
(Seperate Windings) (1-0-2) A 440

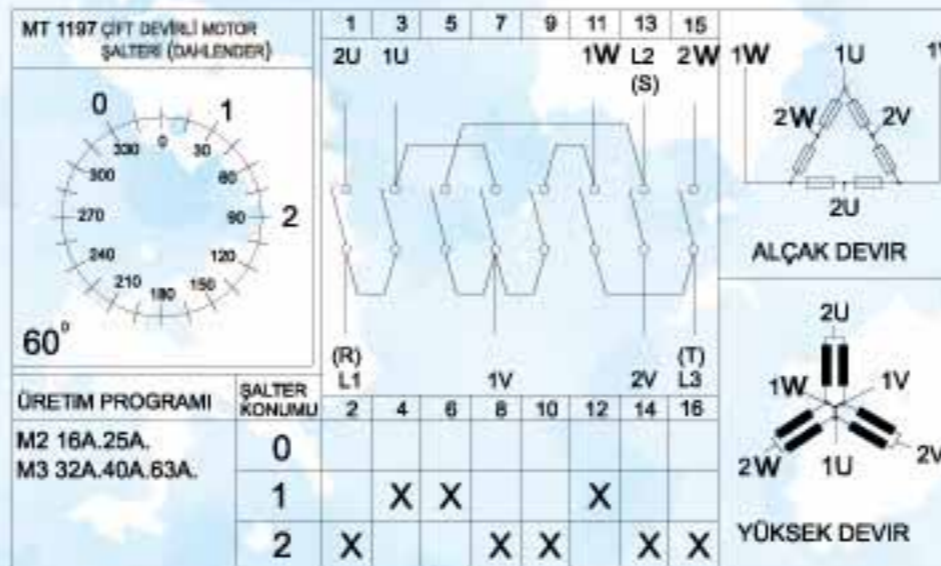

Anma akımı Rated current	Boyut Size	Kutu Ebatları/Box Sizes W x L x H (mm)
16 A	M2	63 x 78 x 121
25 A	M2	63 x 78 x 121
32 A	M3	210 x 112 x 112
40 A	M3	210 x 112 x 112
63 A	M3	210 x 112 x 112

MT063 Ampermetre Komütatör Şalteri
(1 Ampermetre ile 3 Faz Kontrol)
Ammeter Switch (3-Phase
Controlling with 1 Ammeter)

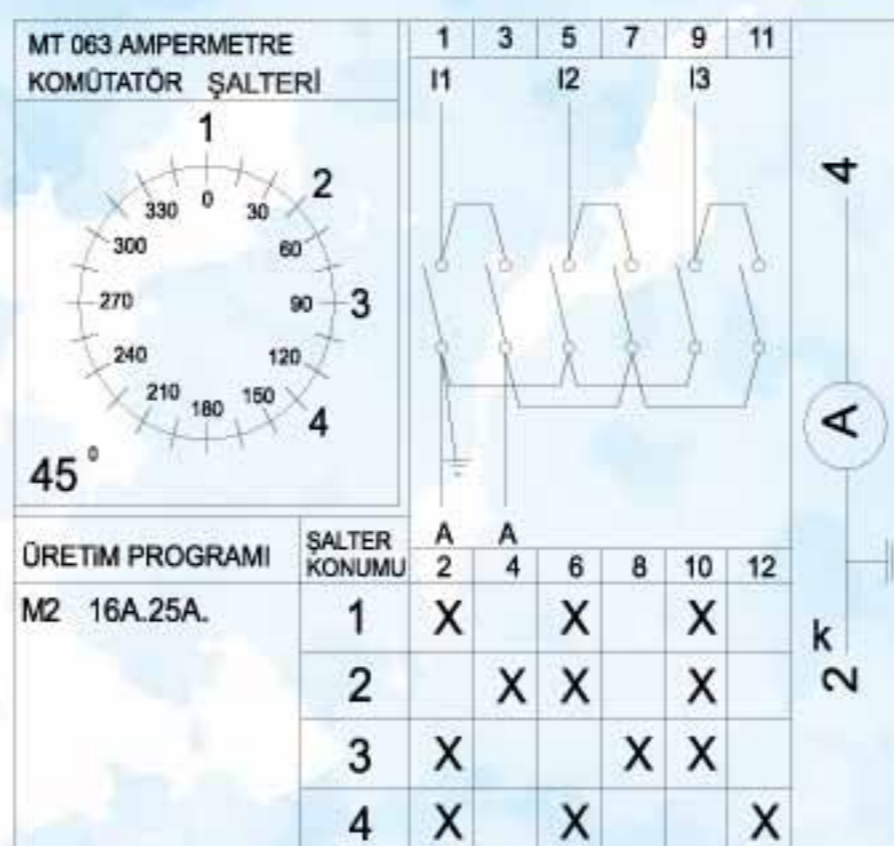
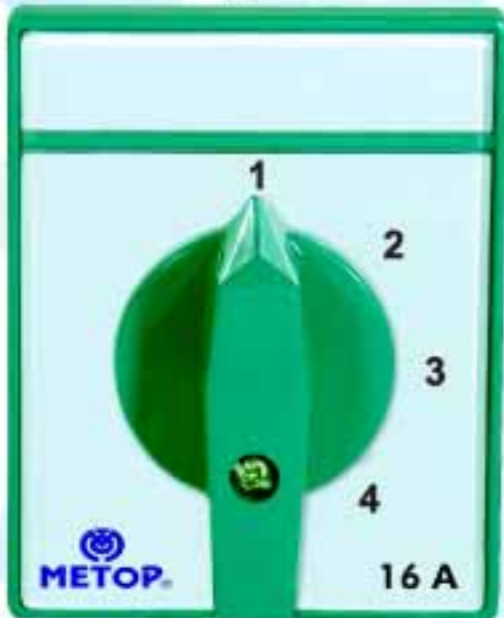

Anma akımı Rated current	Boyut Size	Kutu Ebatları/Box Sizes W x L x H (mm)
16 A	M2	126 x 98 x 68
25 A	M2	126 x 98 x 68

MT022 3 Pozlu Voltmetre Komütatörü
3-Position Voltmeter Switch

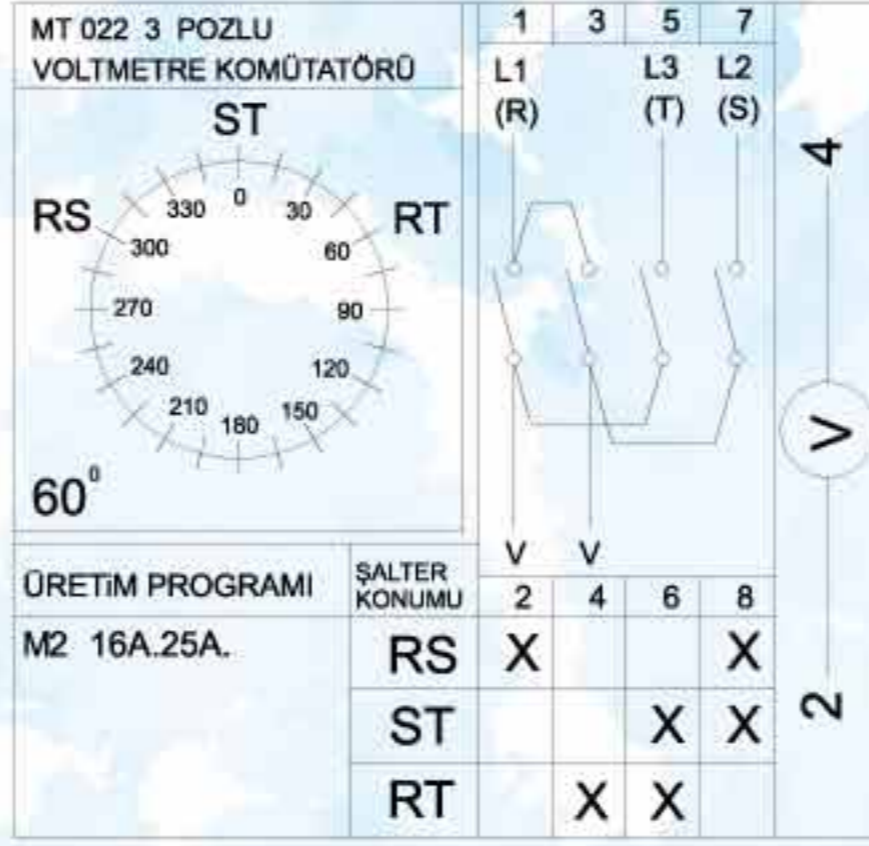

Anma akımı Rated current	Boyut Size	Kutu Ebatları/Box Sizes W x L x H (mm)
16 A	M2	63 x 78 x 90
25 A	M2	63 x 78 x 90

MT050 4 Pozlu Voltmetre Komütatörü
4-Position Voltmeter Switch

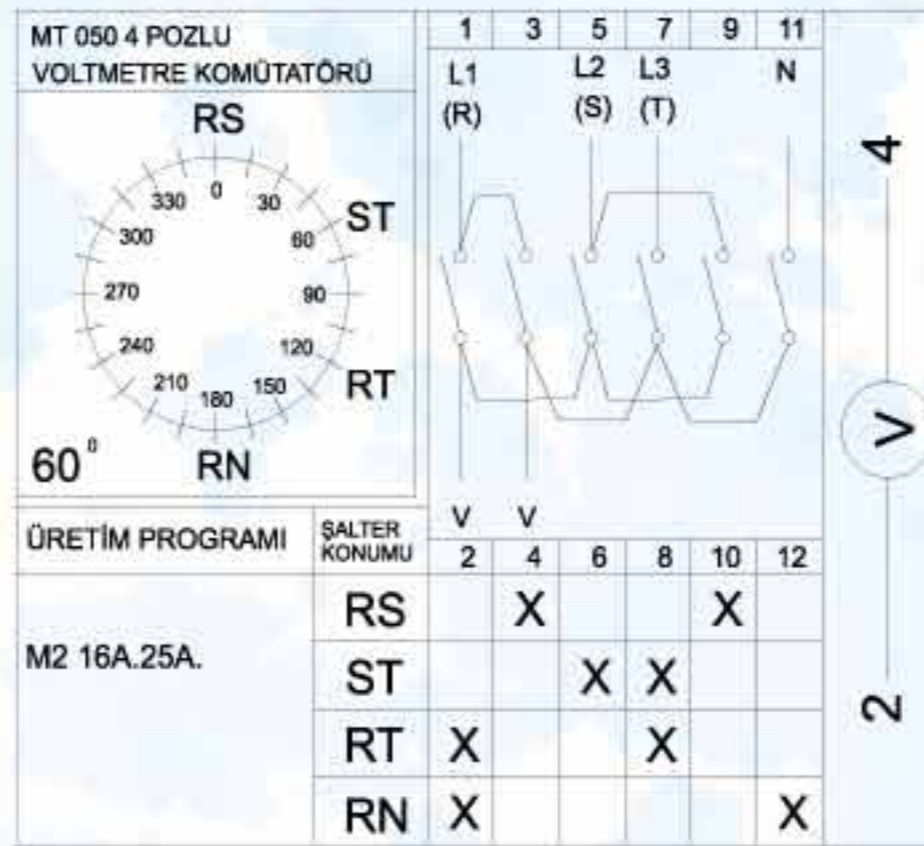
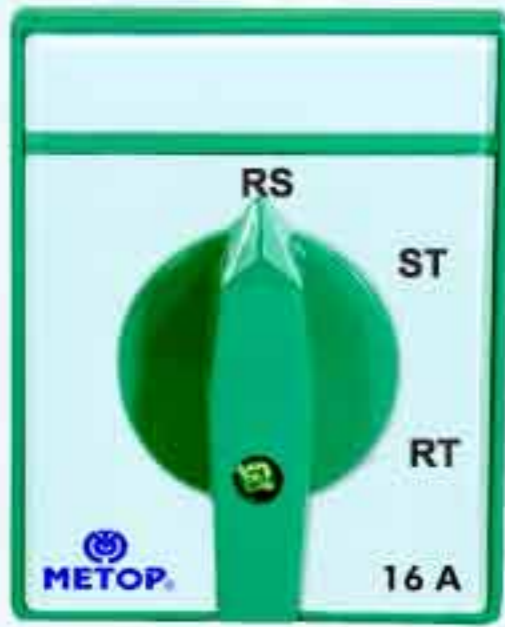

Anma akımı Rated current	Boyut Size	Kutu Ebatları/Box Sizes W x L x H (mm)
16 A	M2	63 x 78 x 106
25 A	M2	63 x 78 x 106

MT1084 6 Pozlu Voltmetre Komütatörü
(Daimi Döner)
6-Position Voltmeter Switch
Rotating (1Voltmeter,1Line, 3 Phase+N)

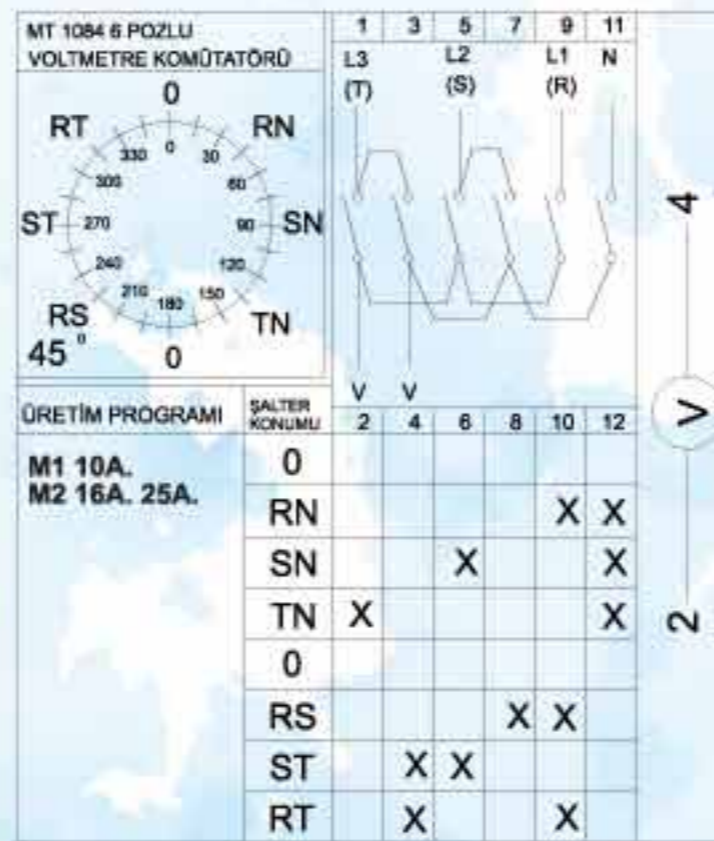
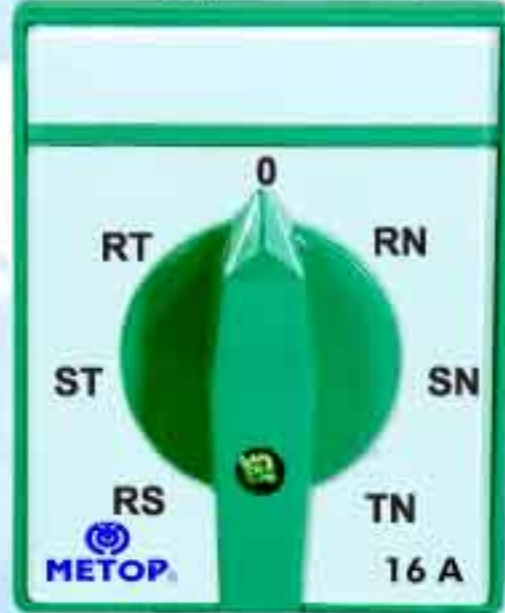

Anma akımı Rated current	Boyut Size	Kutu Ebatları/Box Sizes W x L x H (mm)
10 A	M1	47 x 57 x 89
16 A	M2	63 x 78 x 106
25 A	M2	63 x 78 x 106

MT023 1 Fazlı 2 Kademeli Şalter
1-Pole 2 Ways Switch

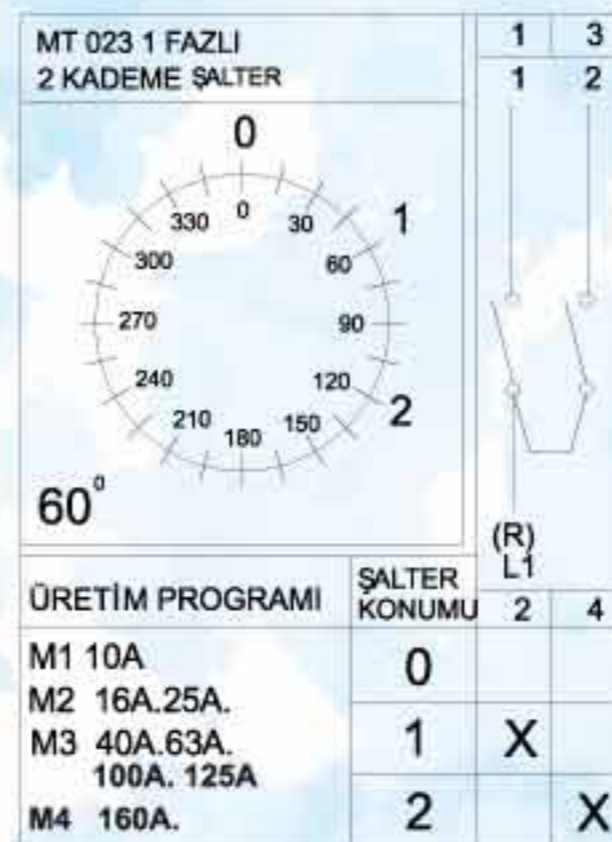
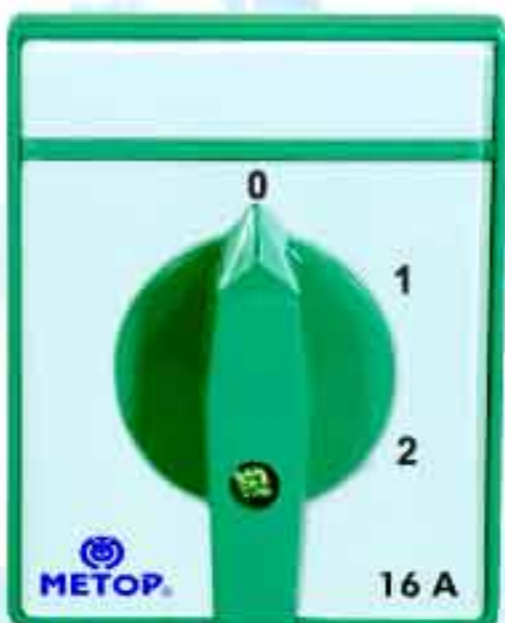

Anma akımı Rated current	Boyut Size	Kutu Ebatları/Box Sizes W x L x H (mm)
10 A	M1	47 x 57 x 63
16 A	M2	63 x 78 x 74
25 A	M2	63 x 78 x 74
32 A	M3	119 x 92 x 112
40 A	M3	119 x 92 x 112
63 A	M3	119 x 92 x 112
100 A	M3	119 x 92 x 112

* 0'sız tipi de vardır. Exists also without "0" position

MT024 1 Fazlı 3 Kademeli Şalter
1-Pole 3 Ways Switch



* 0'sız tipi de vardır. Exists also without "0" position



Anma akımı Rated current	Boyut Size	Kutu Ebatları/Box Sizes W x L x H (mm)
10 A	M1	47x57x76
16 A	M2	63x78x90
25 A	M2	63x78x90
32 A	M3	119x92x112
40 A	M3	119x92x112
63 A	M3	119x92x112
100 A	M3	153x104x109
125 A	M4	153x104x109

MT025 1 Fazlı 4 Kademeli Şalter
1-Pole 4 Ways Switch

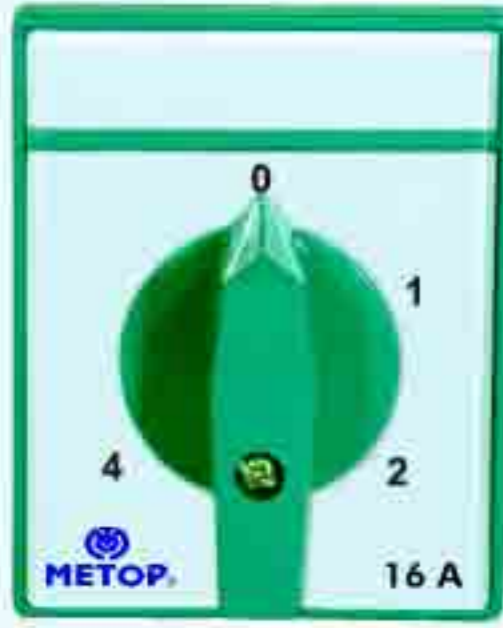

* 0'sız tipi de vardır. Exists also without "0" position

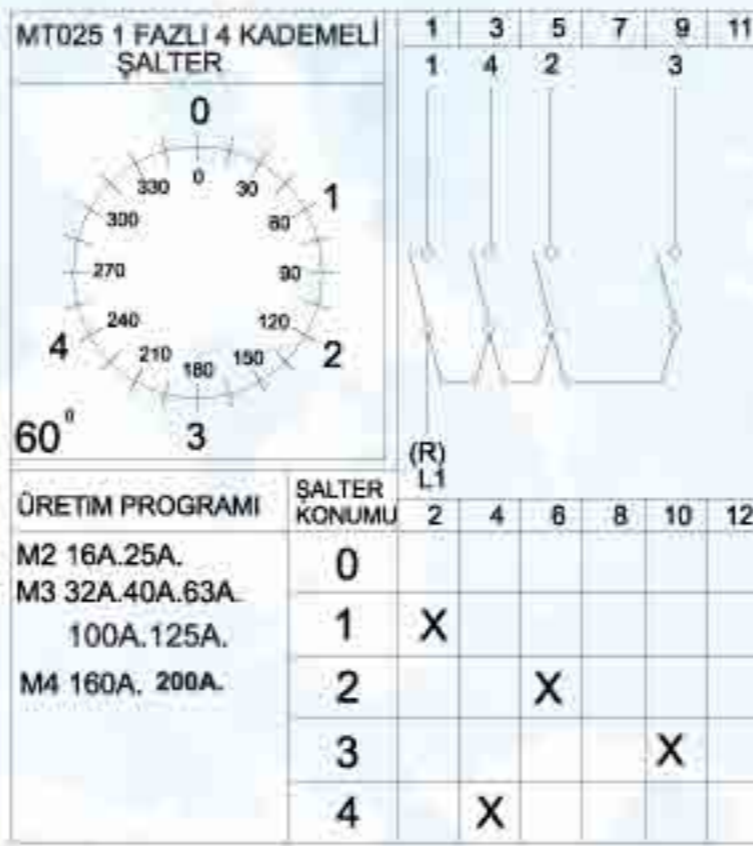

Anma akımı Rated current	Boyut Size	Kutu Ebatları/Box Sizes W x L x H (mm)
10 A	M1	47x57x89
16 A	M2	63x78x106
25 A	M2	63x78x106
32 A	M3	134x92x112
40 A	M3	134x92x112
63 A	M3	134x92x112
100 A	M3	211x108x112
125 A	M3	211x108x112

MT026 1 Fazlı 5 Kademeli Şalter
1-Pole 5 Ways Switch



* 0'sız tipi de vardır. Exists also without "0" position

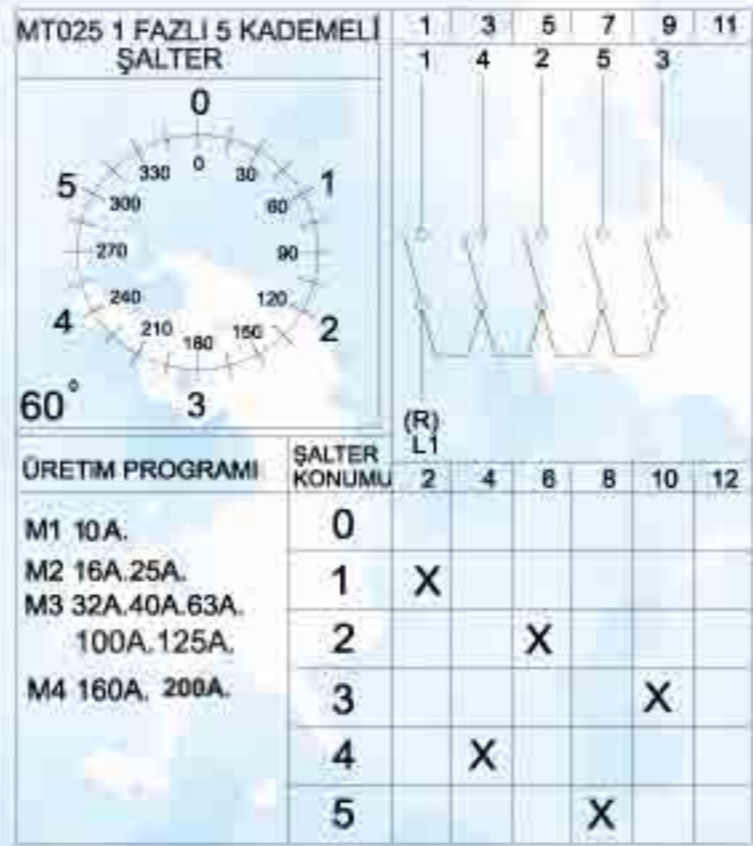

Anma akımı Rated current	Boyut Size	Kutu Ebatları/Box Sizes W x L x H (mm)
10 A	M1	47x57x89
16 A	M2	63x78x106
25 A	M2	63x78x106
32 A	M3	134x92x112
40 A	M3	134x92x112
63 A	M3	134x92x112
100 A	M3	211x108x112
125 A	M3	211x108x112

MT061 1 Fazlı 6 Kademeli Şalter
1-Pole 6 Ways Switch



* 0'sız tipi de vardır. Exists also without "0" position

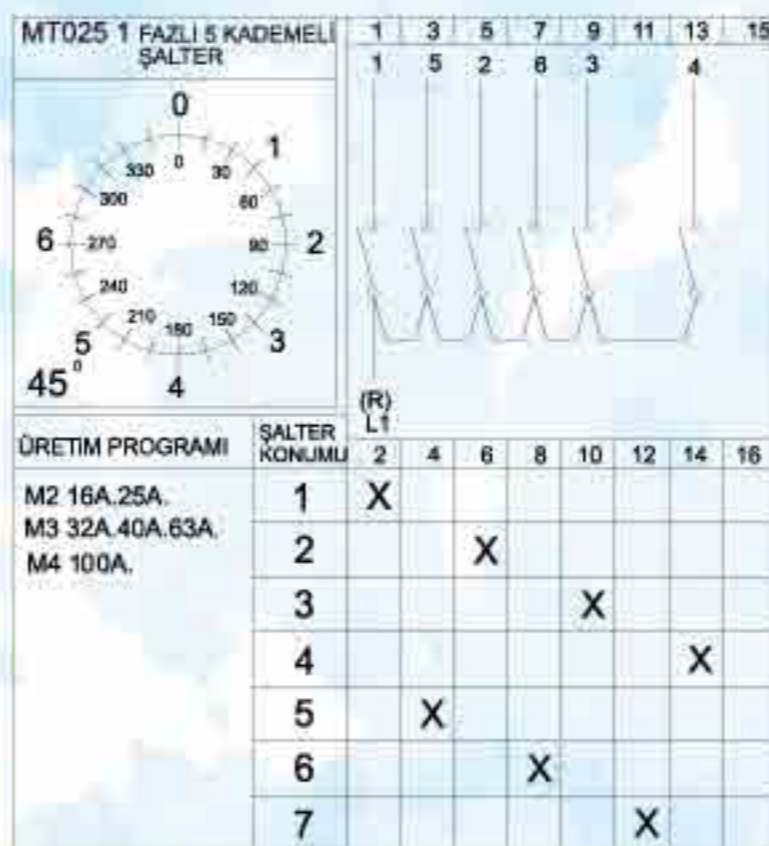

Anma akımı Rated current	Boyut Size	Kutu Ebatları/Box Sizes W x L x H (mm)
16 A	M2	63x78x121
25 A	M2	63x78x121
32 A	M3	160x92x112
40 A	M3	160x92x112
63 A	M3	160x92x112

MT062 1 Fazlı 7 Kademeli Şalter
1-Pole 7 Ways Switch



Anma akımı Rated current	Boyut Size	Kutu Ebatları/Box Sizes W x L x H (mm)
16 A	M 2	63x78x121
25 A	M 2	63x78x121
32 A	M 3	160x92x112
40 A	M 3	160x92x112
63 A	M 3	160x92x112

MT066 1 Fazlı 8 Kademeli Şalter
1-Pole 8 Ways Switch

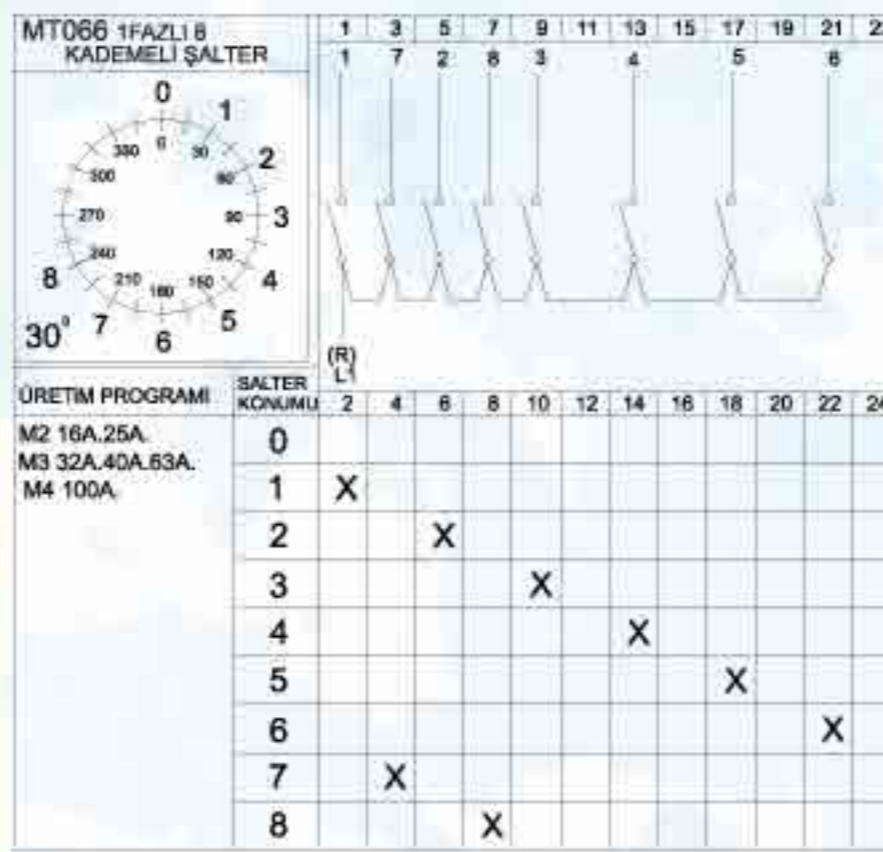

Anma akımı Rated current	Boyut Size	Kutu Ebatları/Box Sizes W x L x H (mm)
16 A	M 2	185x78x67
25 A	M 2	185x78x68
32 A	M 3	210x112x112
40 A	M 3	210x112x112
63 A	M 3	210x112x112

* 0'sız tipi de vardır. Exists also without "0" position

MT067 1 Fazlı 9 Kademeli Şalter
1-Pole 9 Ways Switch

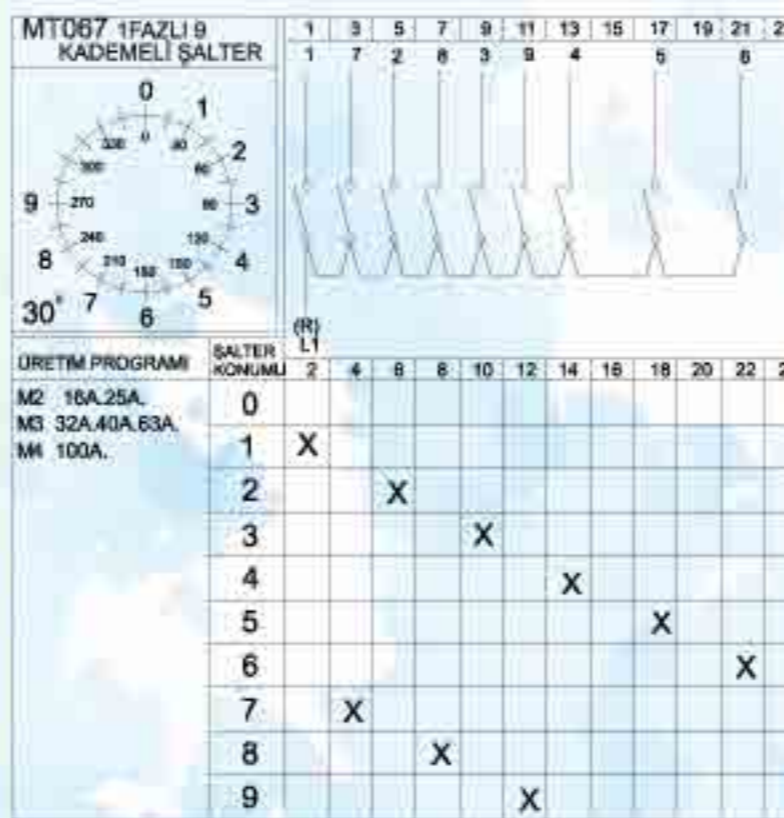

Anma akımı Rated current	Boyut Size	Kutu Ebatları/Box Sizes W x L x H (mm)
16 A	M 2	185x78x67
25 A	M 2	185x78x68
32 A	M 3	210x112x112
40 A	M 3	210x112x112

* 0'sız tipi de vardır. Exists also without "0" position

MT068 1 Fazlı 10 Kademeli Şalter
1-Pole 10 Ways Switch

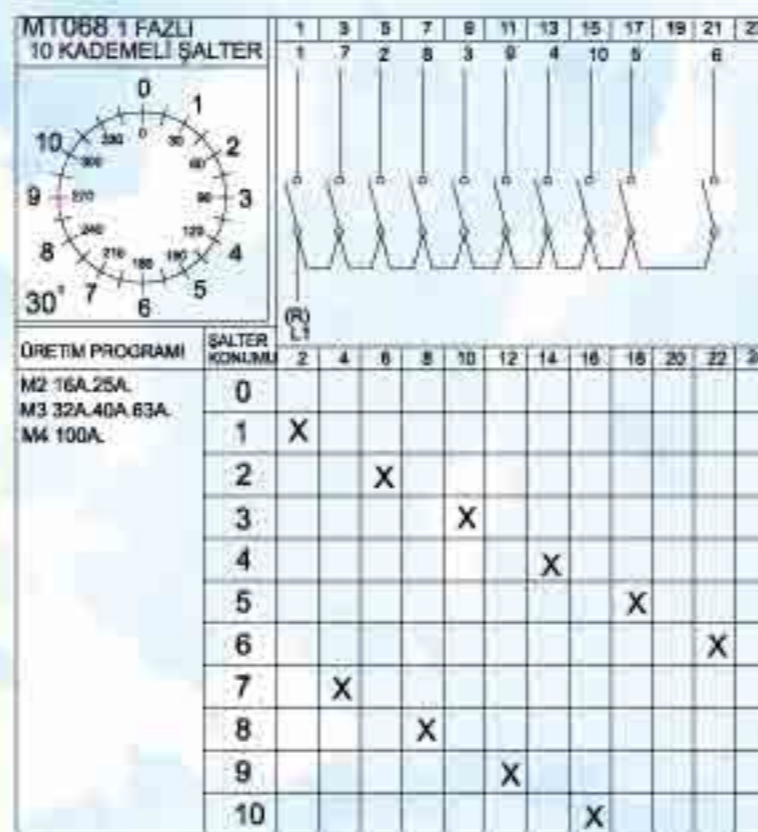

Anma akımı Rated current	Boyut Size	Kutu Ebatları/Box Sizes W x L x H (mm)
16 A	M 2	185x78x67
25 A	M 2	185x78x68
32 A	M 3	210x112x112
40 A	M 3	210x112x112

* 0'sız tipi de vardır. Exists also without "0" position

MT084 1 Fazlı 3 Kademeli Şebekeli Şalter
1-Pole 3 Ways Switch with Auxillary Contact



* 0'sız tipi de vardır. Exists also without "0" position



MT036 1 Fazlı 5 Kademeli Şebekeli Şalter
1 Pole 5 Ways Switch with Auxillary Contact



* 0'sız tipi de vardır. Exists also without "0" position

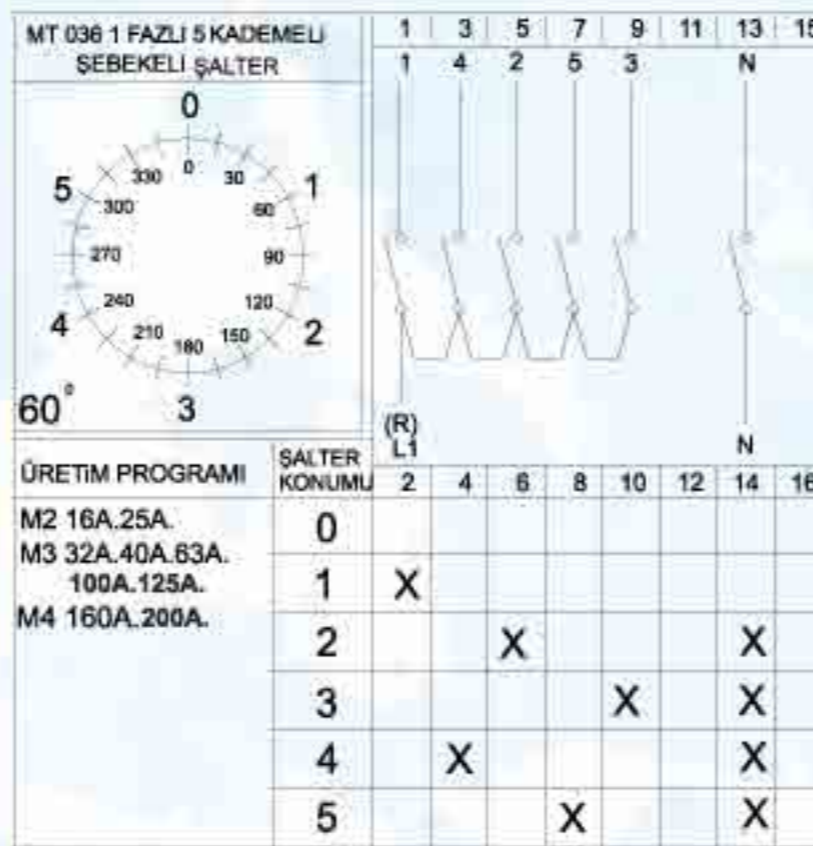

Anma akımı Rated current	Boyut Size	Kutu Ebatları/Box Sizes W x L x H (mm)
16A	M2	63 x 78 x 121
25A	M2	63 x 78 x 121
32A	M3	160 x 92 x 112
40A	M3	160 x 92 x 112
63A	M3	160 x 92 x 112

MT064 1 Fazlı 6 Kademeli Şebekeli Şalter
1 Pole 6 Ways Switch with Auxillary Contact



* 0'sız tipi de vardır. Exists also without "0" position

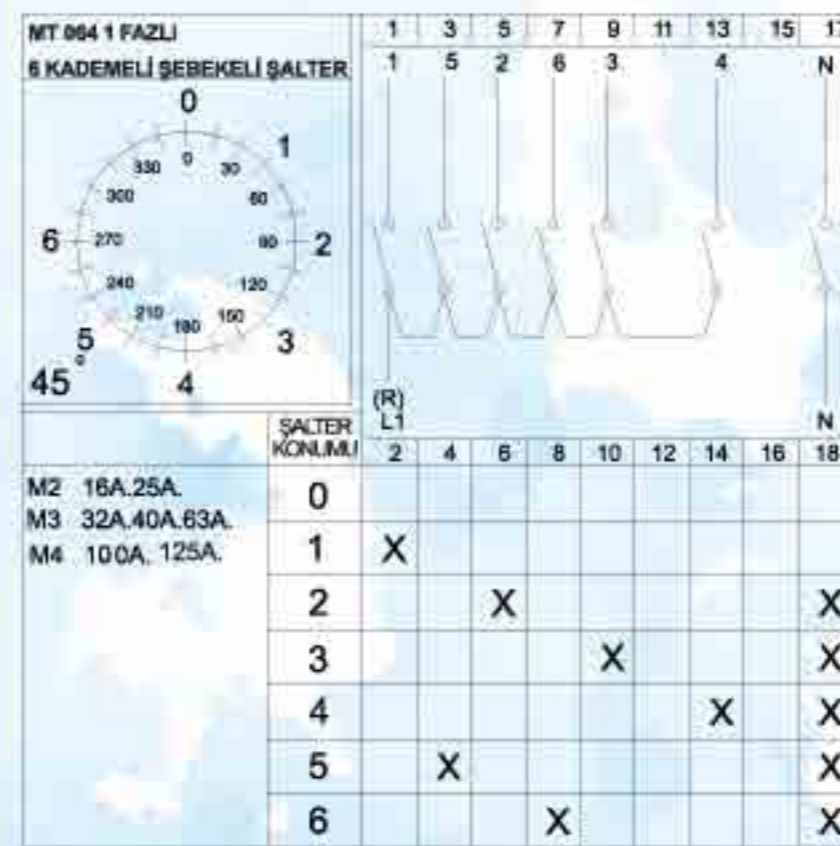

Anma akımı Rated current	Boyut Size	Kutu Ebatları/Box Sizes W x L x H (mm)
16A	M2	63 x 78 x 121
25A	M2	63 x 78 x 121
32A	M3	160 x 92 x 112
40A	M3	160 x 92 x 112
63A	M3	160 x 92 x 112

MT065 1 Fazlı 7 Kademeli Şebekeli Şalter
1 Pole 7 Ways Switch with Auxillary Contact

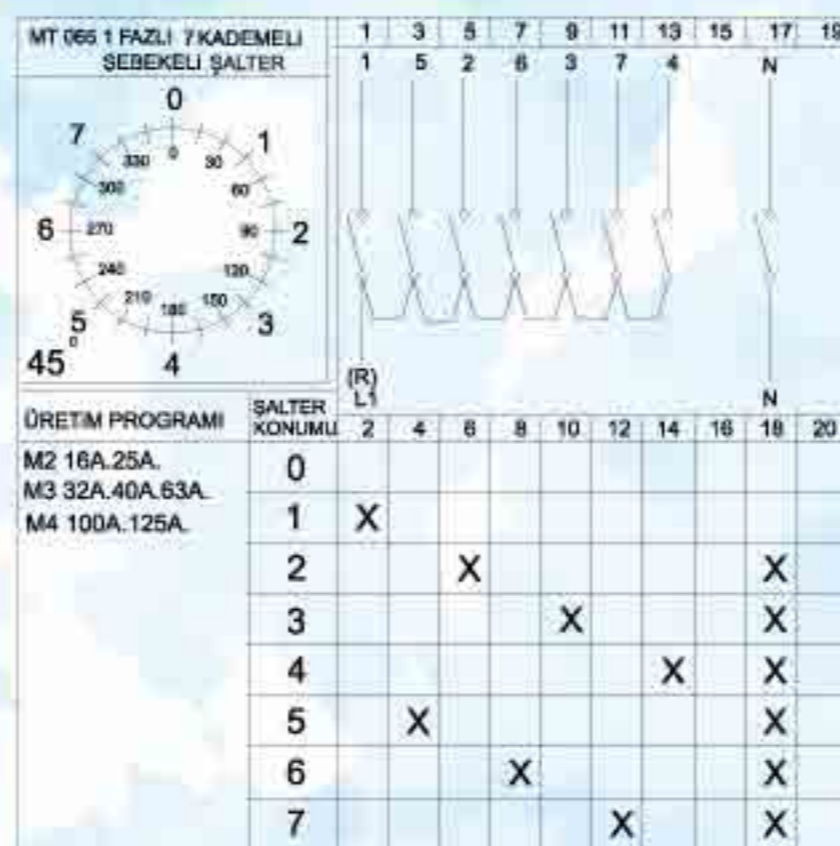

MT032 1 Fazlı 2 Kademeli Seçici Şalter (Toplamalı)
1-Pole 2 Ways Multistep Switch



Anma akımı Rated current	Boyut Size	Kutu Ebatları/Box Sizes W x L x H (mm)
10 A	M1	47x57x63
16 A	M2	63x78x74
25 A	M2	63x78x74
32 A	M3	119x92x112
40 A	M3	119x92x112
63 A	M3	119x92x112
100 A	M3	119x92x112

MT033 1 Fazlı 3 Kademeli Seçici Şalter (Toplamalı)
1-Pole 3 Ways Multistep Switch

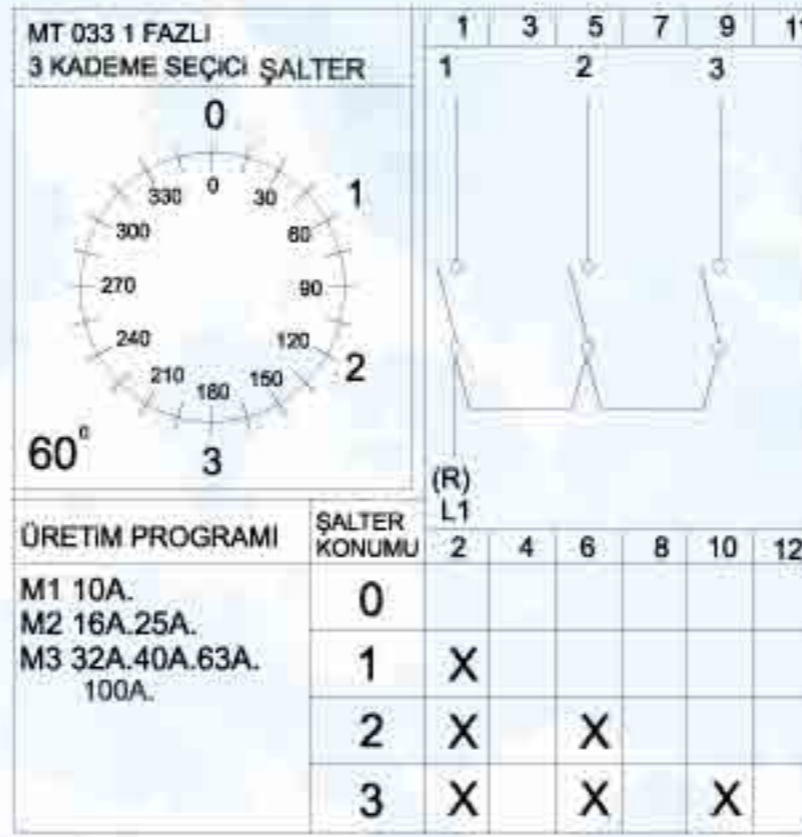

Anma akımı Rated current	Boyut Size	Kutu Ebatları/Box Sizes W x L x H (mm)
10 A	M1	47x57x76
16 A	M2	63x78x90
25 A	M2	63x78x90
32 A	M3	119x92x112
40 A	M3	119x92x112
63 A	M3	119x92x112

* 0'sız tipi de vardır. Exists also without "0" position

MT034 1 Fazlı 4 Kademeli Seçici Şalter (Toplamalı)
1-Pole 4 Ways Multistep Switch



Anma akımı Rated current	Boyut Size	Kutu Ebatları/Box Sizes W x L x H (mm)
10 A	M1	47x57x76
16 A	M2	63x78x90
25 A	M2	63x78x90
32 A	M3	119x92x112
40 A	M3	119x92x112
63 A	M3	119x92x112

MT049 3 Fazlı 2 Kademeli Şalter
3-Pole 2 Ways Switch

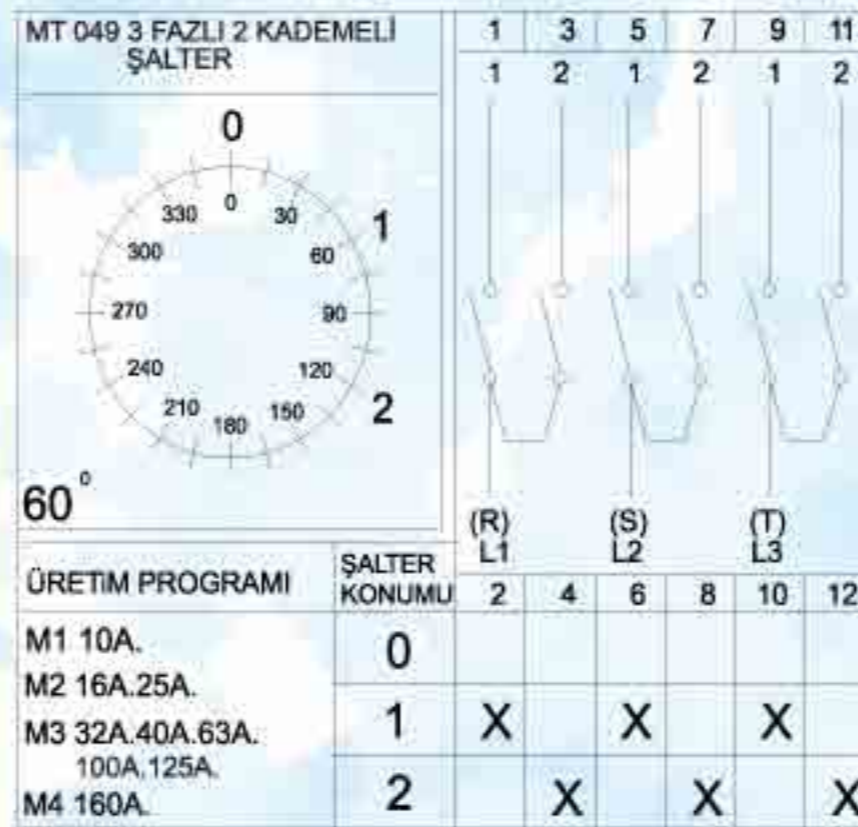
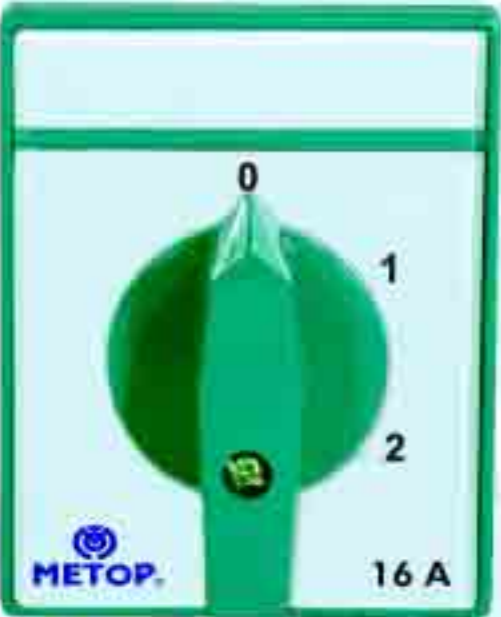

Anma akımı Rated current	Boyut Size	Kutu Ebatları/Box Sizes W x L x H (mm)
10A	M 1	126x98x68
16A	M 2	168x98x68
25A	M 2	168x98x68
32A	M 3	134x92x112
40A	M 3	134x92x112
63A	M 3	134x92x112
100A	M 3	210x112x112
125A	M 3	210x112x112

* 0'sız tipi de vardır. Exists also without "0" position

MT051 3 Fazlı 3 Kademeli Şalter
3-Pole 3 Ways Switch

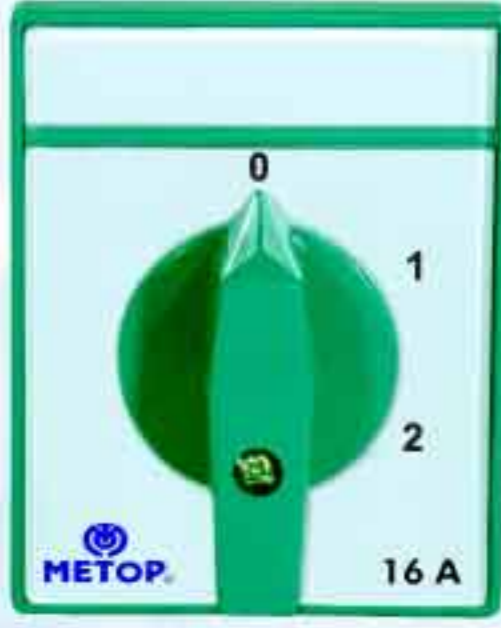

* 0'sız tipi de vardır. Exists also without "0" position

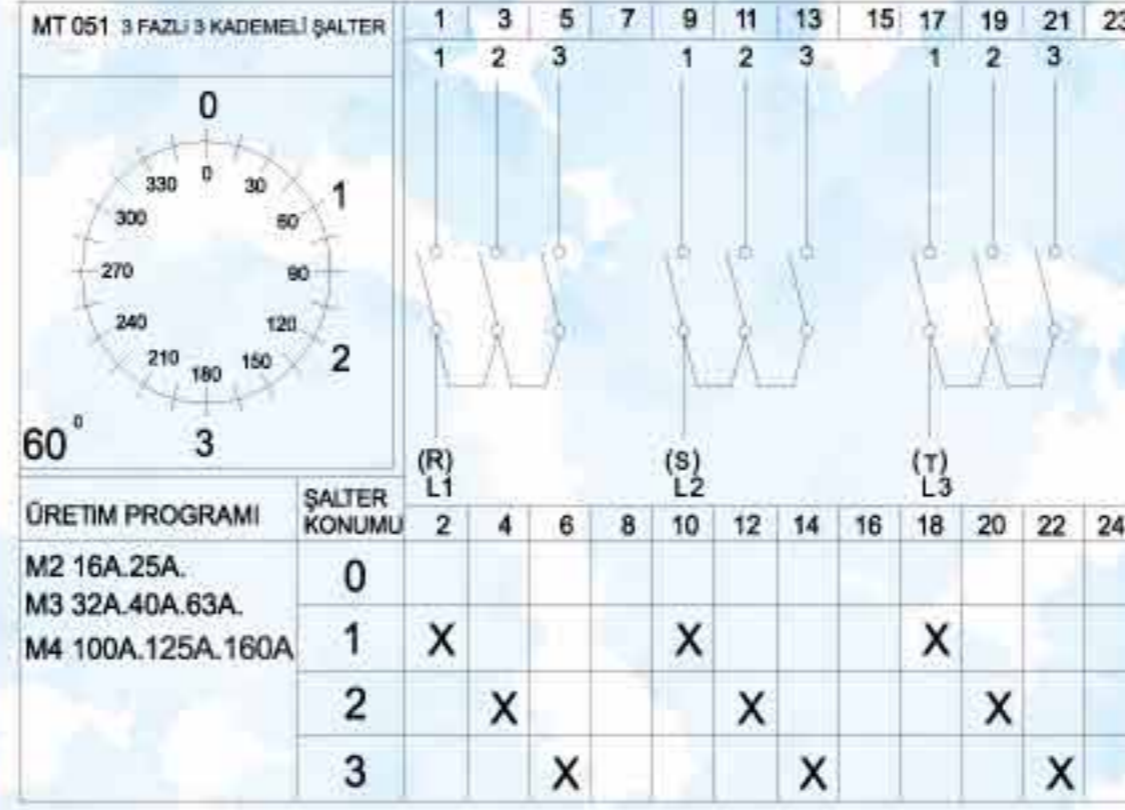

Anma akımı Rated current	Boyut Size	Kutu Ebatları/Box Sizes W x L x H (mm)
16A	M2	185x78x68
25A	M2	185x78x68
32A	M3	210x112x112
40A	M3	210x112x112
63A	M3	210x112x112

MT052 3 Fazlı 4 Kademeli Şalter
3-Pole 4 Ways Switch

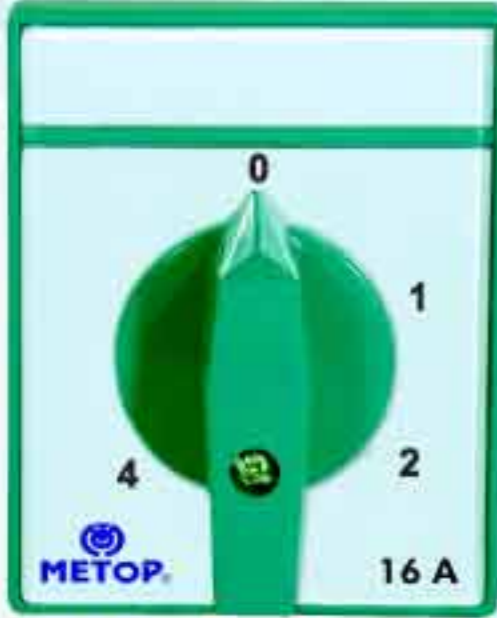

* 0'sız tipi de vardır. Exists also without "0" position

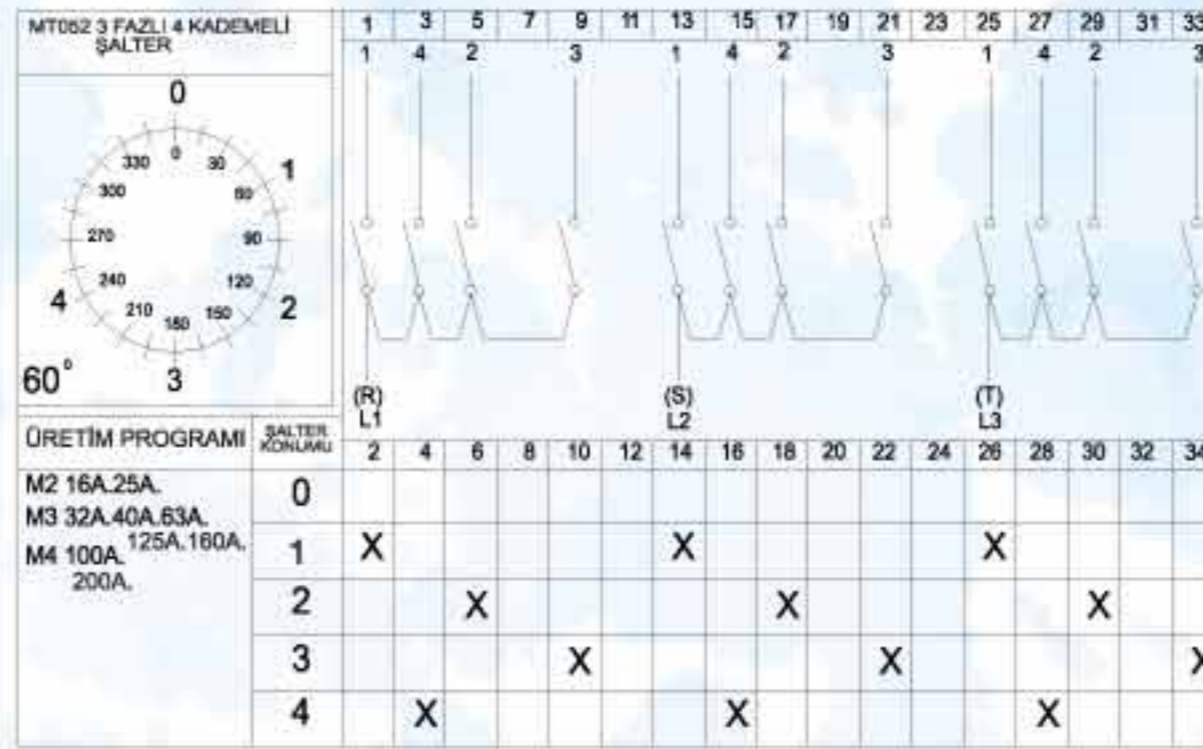

Anma akımı Rated current	Boyut Size	Kutu Ebatları/Box Sizes W x L x H (mm)
16A	M2	196x75x68
25A	M2	196x75x68
32A	M3	265x108x90
40A	M3	265x108x90
63A	M3	265x108x90

MT053 3 Fazlı 5 Kademeli Şalter
3-Pole 5 Ways Switch



* 0'sız tipi de vardır. Exists also without "0" position

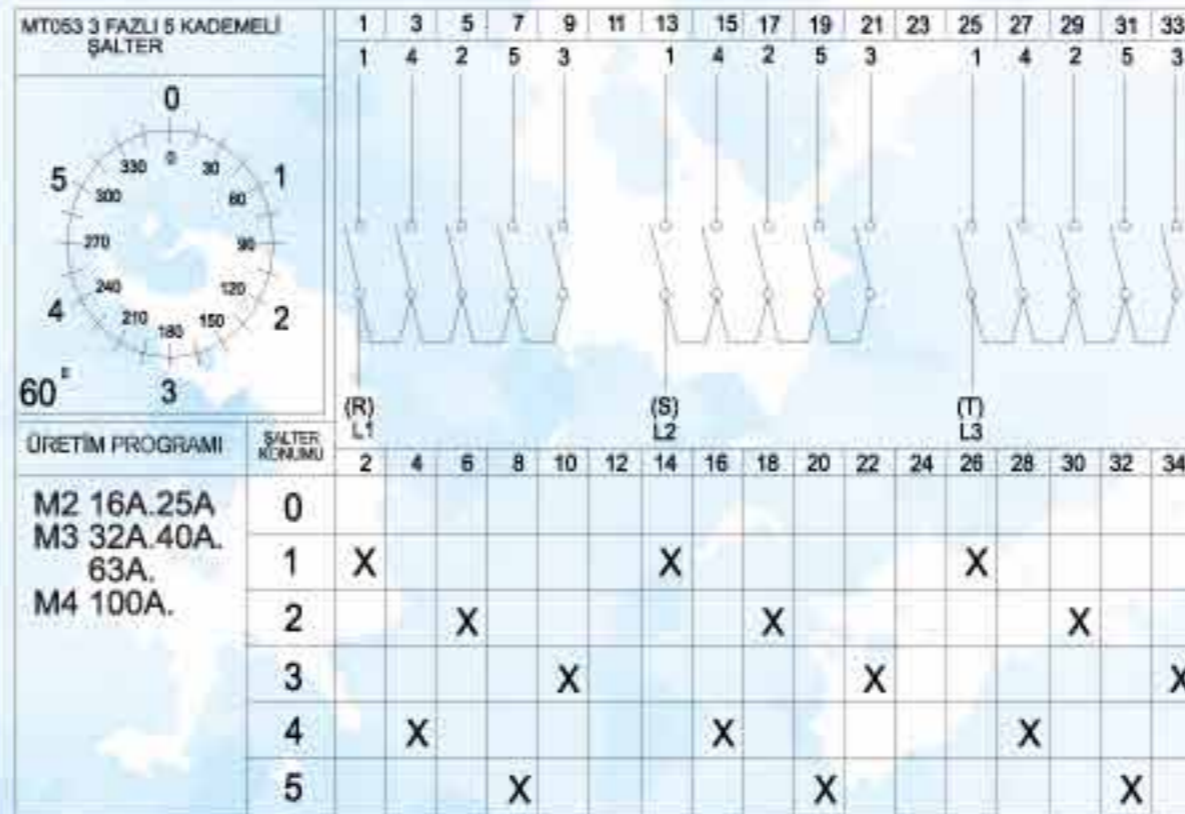

Anma akımı Rated current	Boyut Size	Kutu Ebatları/Box Sizes W x L x H (mm)
16A	M2	190x80x68
25A	M2	190x80x68
32A	M3	265x108x90
40A	M3	265x108x90
63A	M3	265x108x90

MT011 3 Fazlı 6 Kademeli Şalter
3-Pole 6 Ways Switch



* 0'sız tipi de vardır. Exists also without "0" position

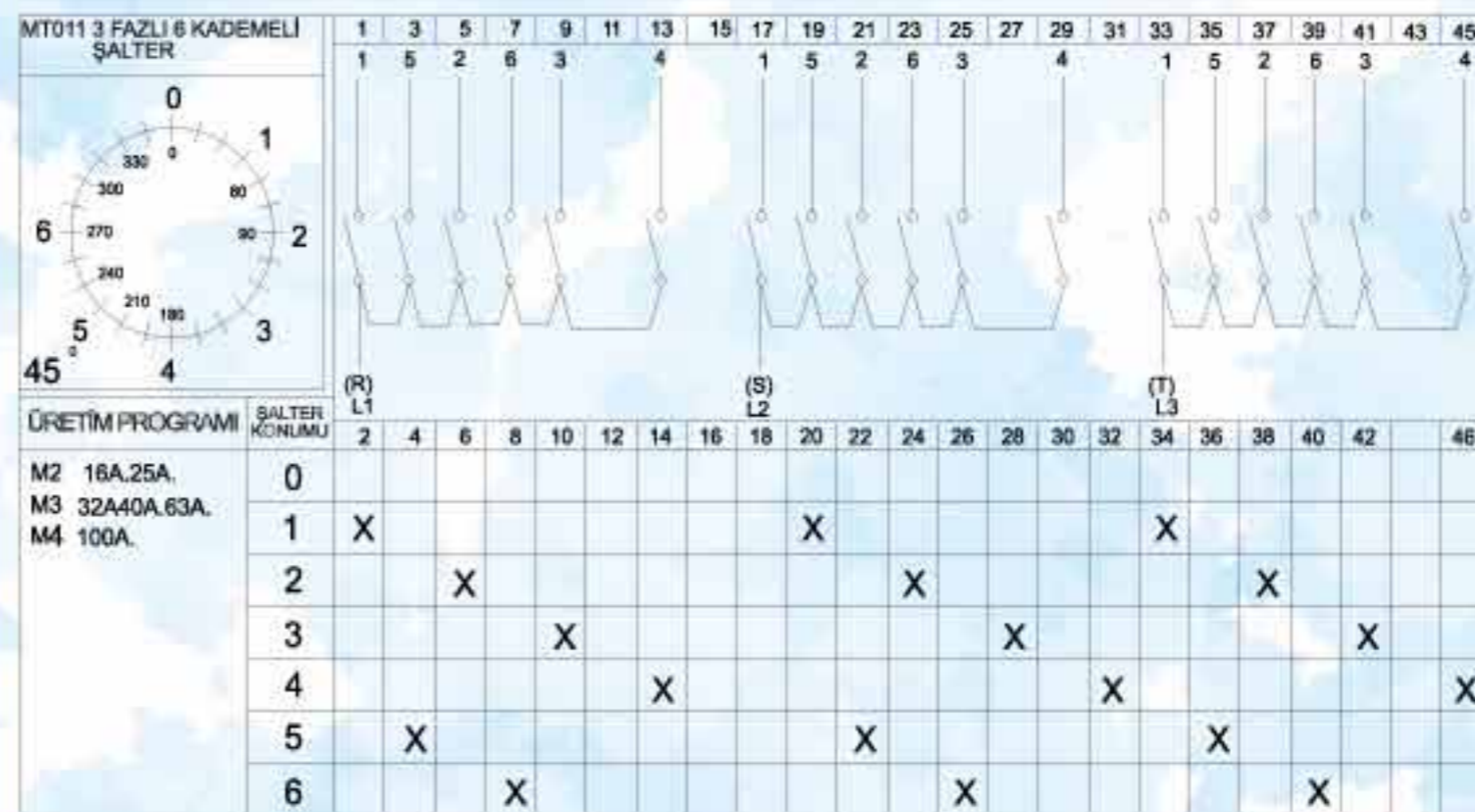

MT012 3 Fazlı 7 Kademeli Şalter
3-Pole 7 Ways Switch



* 0'sız tipi de vardır. Exists also without "0" position

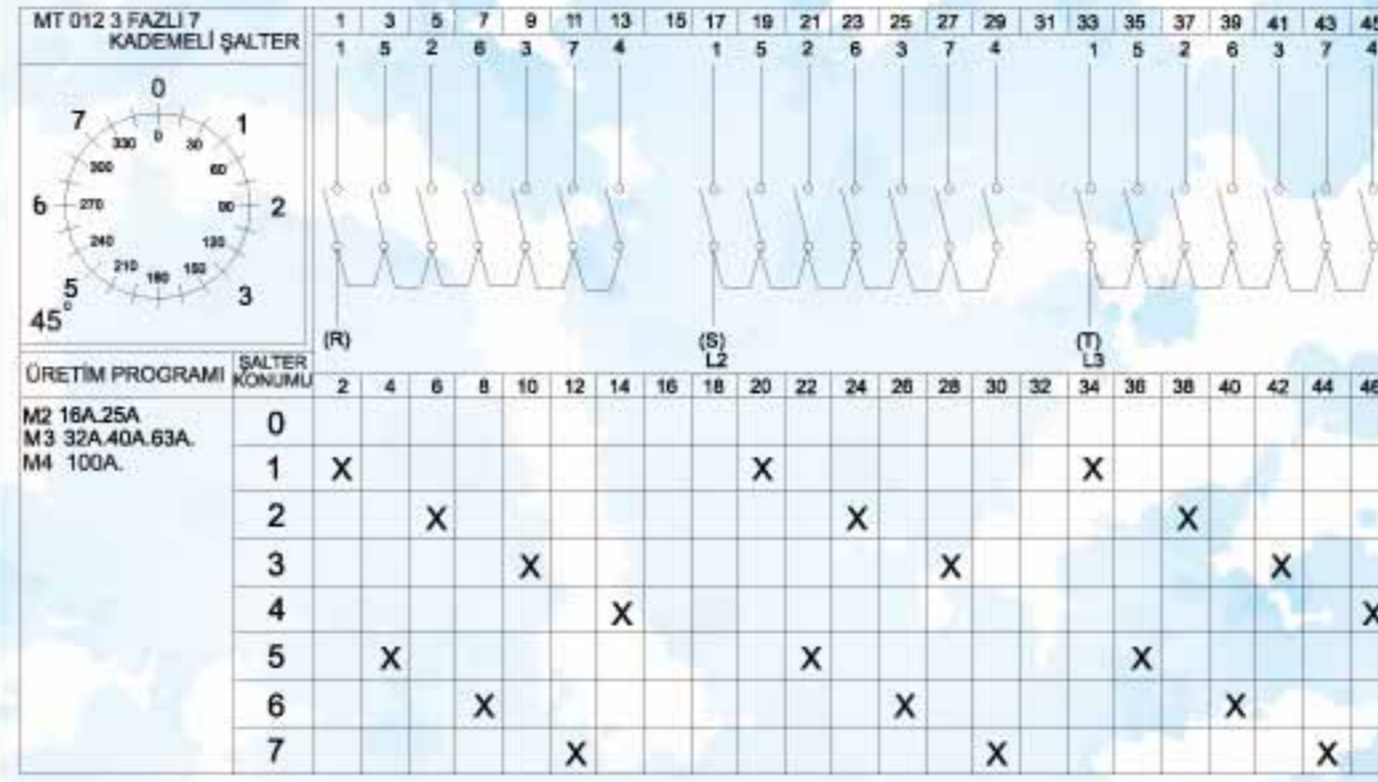

MT013 3 Fazlı 8 Kademeli Şalter
3-Pole 8 Ways Switch

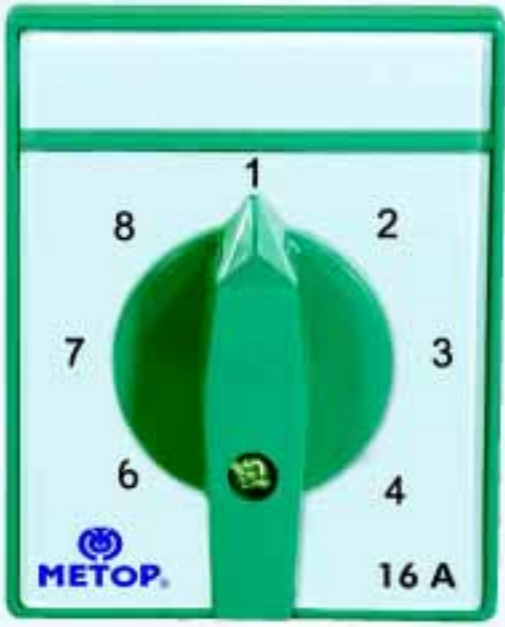

* 0'sız tipi de vardır. Exists also without "0" position

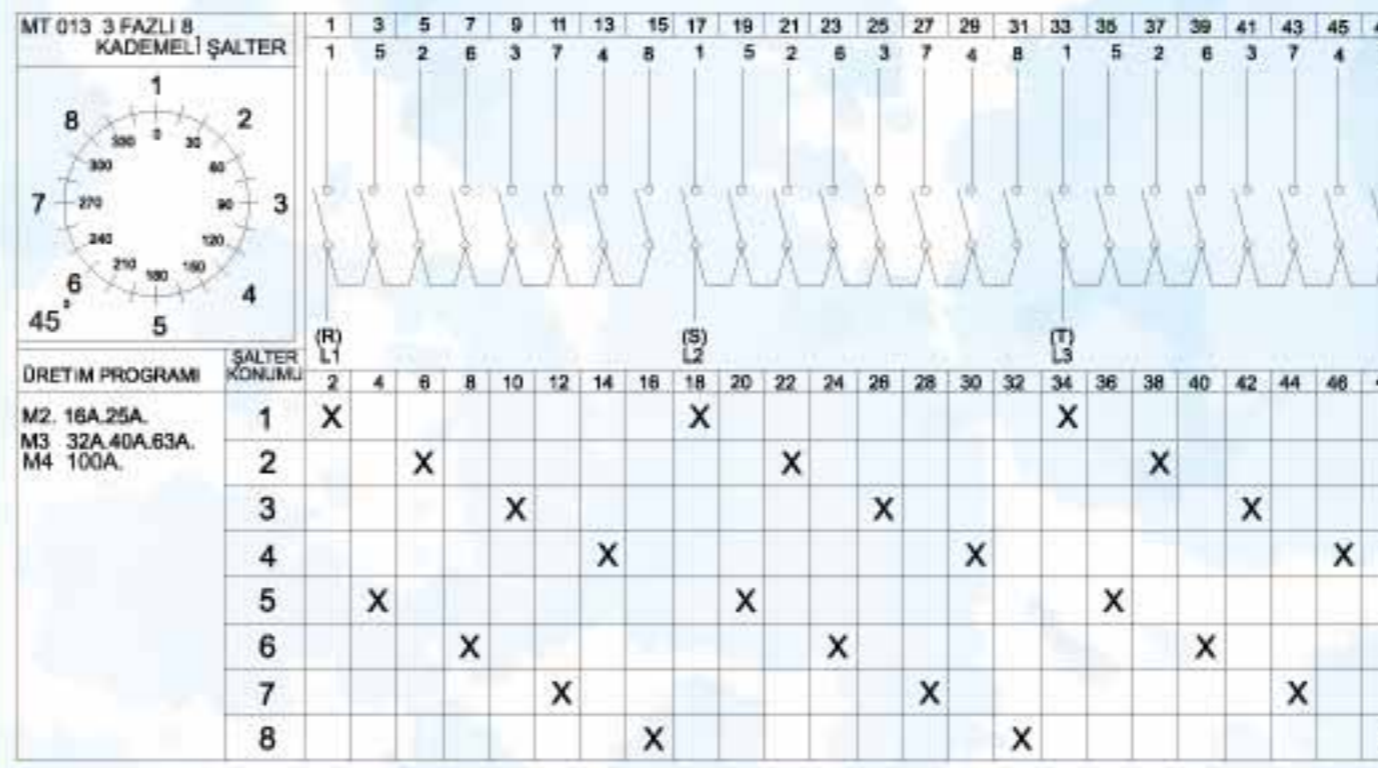

MT1073 Gaz Altı Kaynak Makinesi İçin
7 Kademeli Şalter
Welding Machine Switch 7 Ways

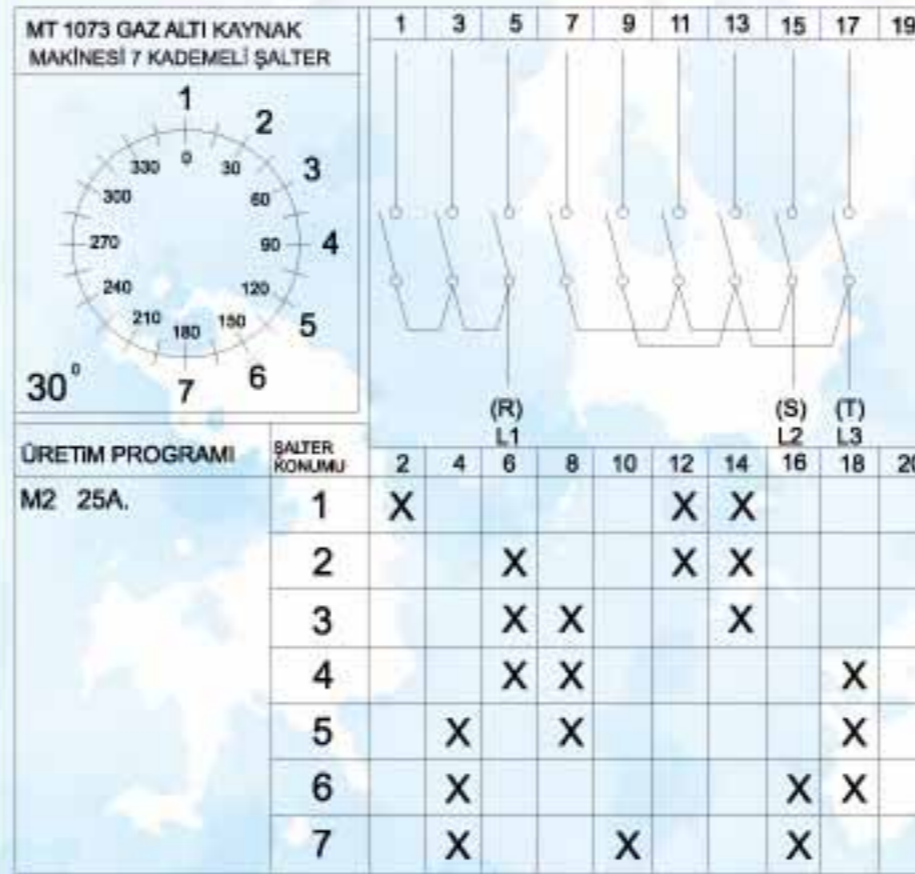
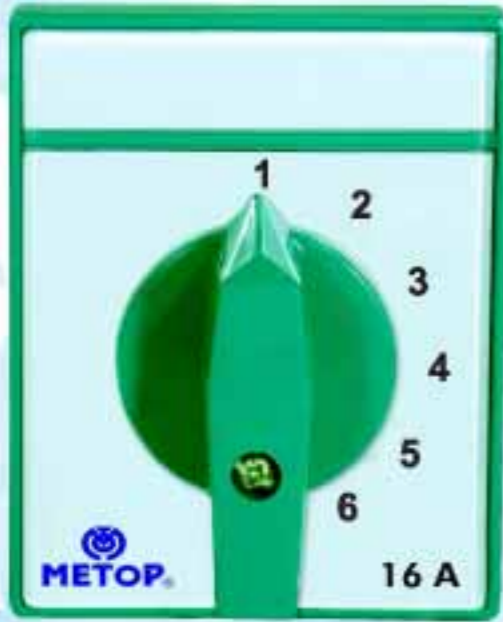

Anma akımı Rated current	Boyut Size	Kutu Ebatları/Box Sizes W x L x H (mm)
25A	M2	185x78x68

MT1074 Gaz Altı Kaynak Makinesi İçin
3 Kademeli Şalter
Welding Machine Switch 3 Ways

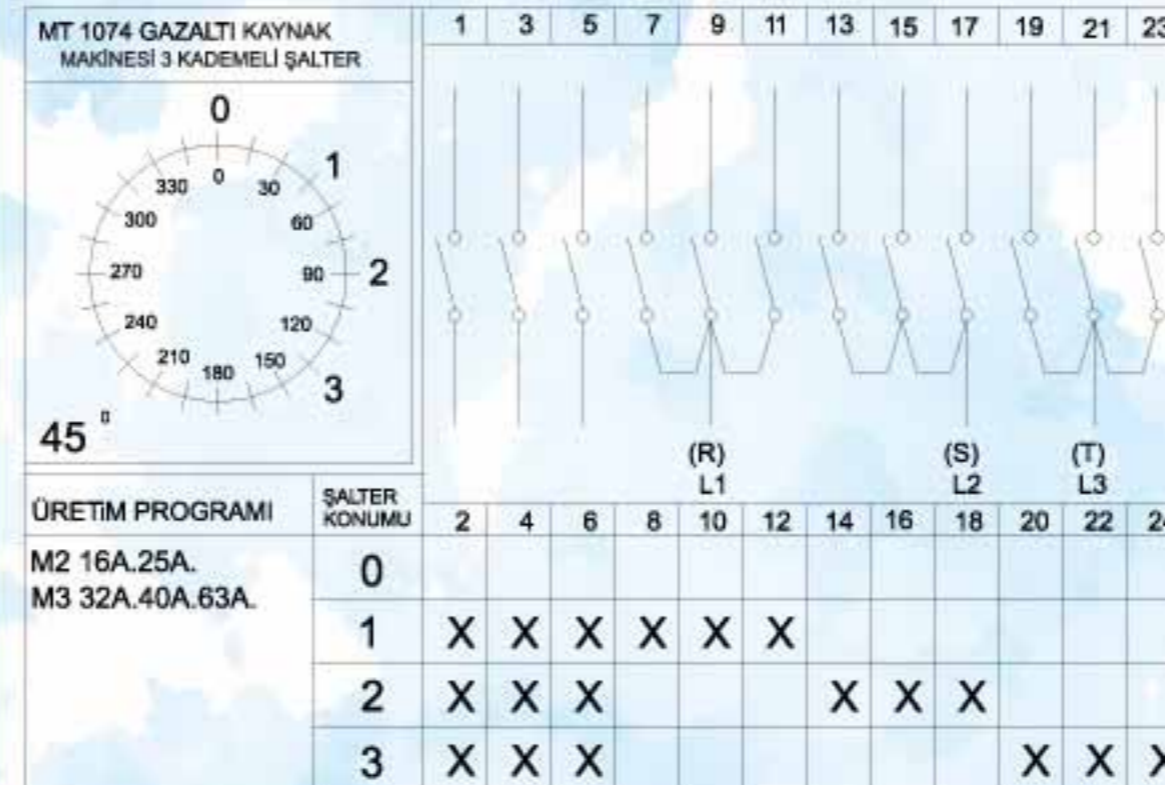
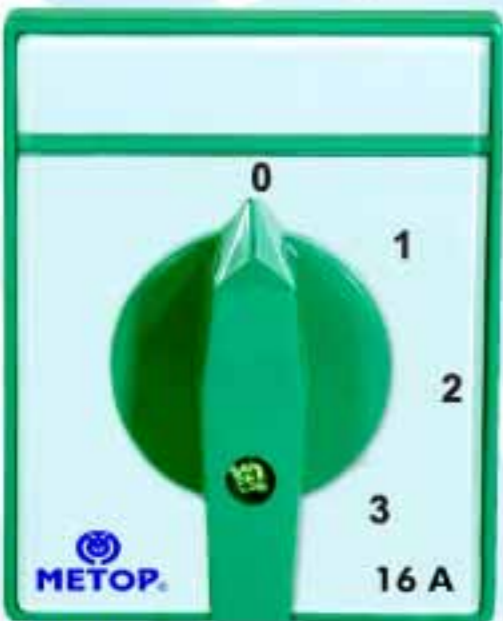

Anma akımı Rated current	Boyut Size	Kutu Ebatları/Box Sizes W x L x H (mm)
25A	M2	185x78x68
32A	M3	210x112x112
40A	M3	210x112x112
63A	M3	210x112x112

MT1173 Gaz Altı Kaynak Makinesi Şalteri 10 Kademeli
Welding Machine Switch 10 Ways

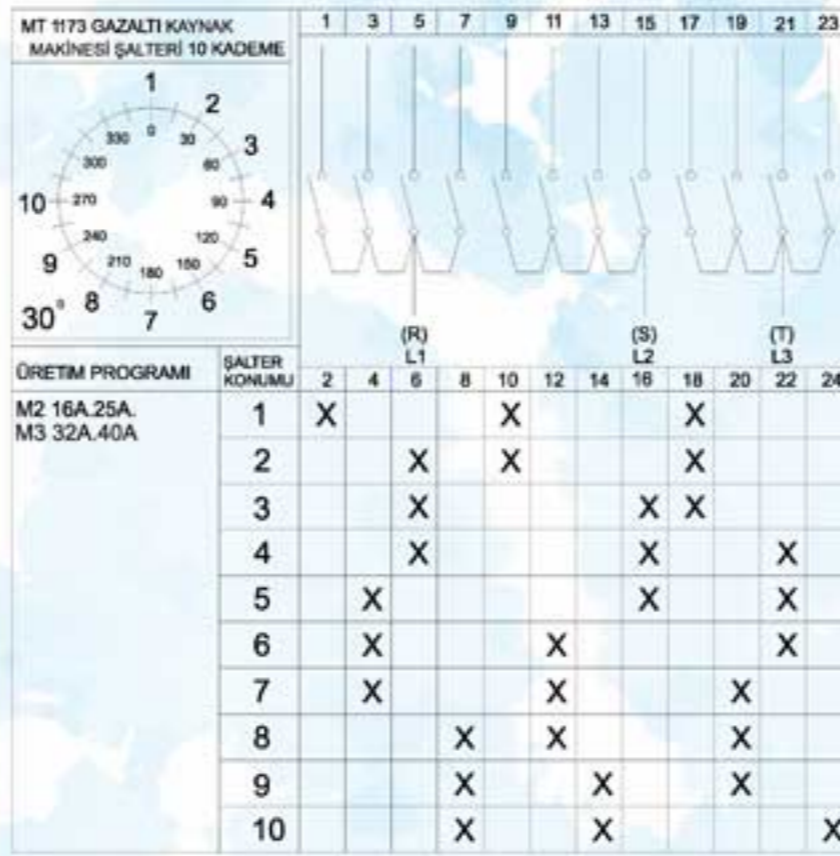

Anma akımı Rated current	Boyut Size	Kutu Ebatları/Box Sizes W x L x H (mm)
16 A	M 2	185x78x68
25 A	M 2	185x78x68
32 A	M 3	210x112x112
40 A	M 3	210x112x112

MT079 Yüksek Gerilim Kesici Start Şalteri
High Tension Breaker Starting Switch

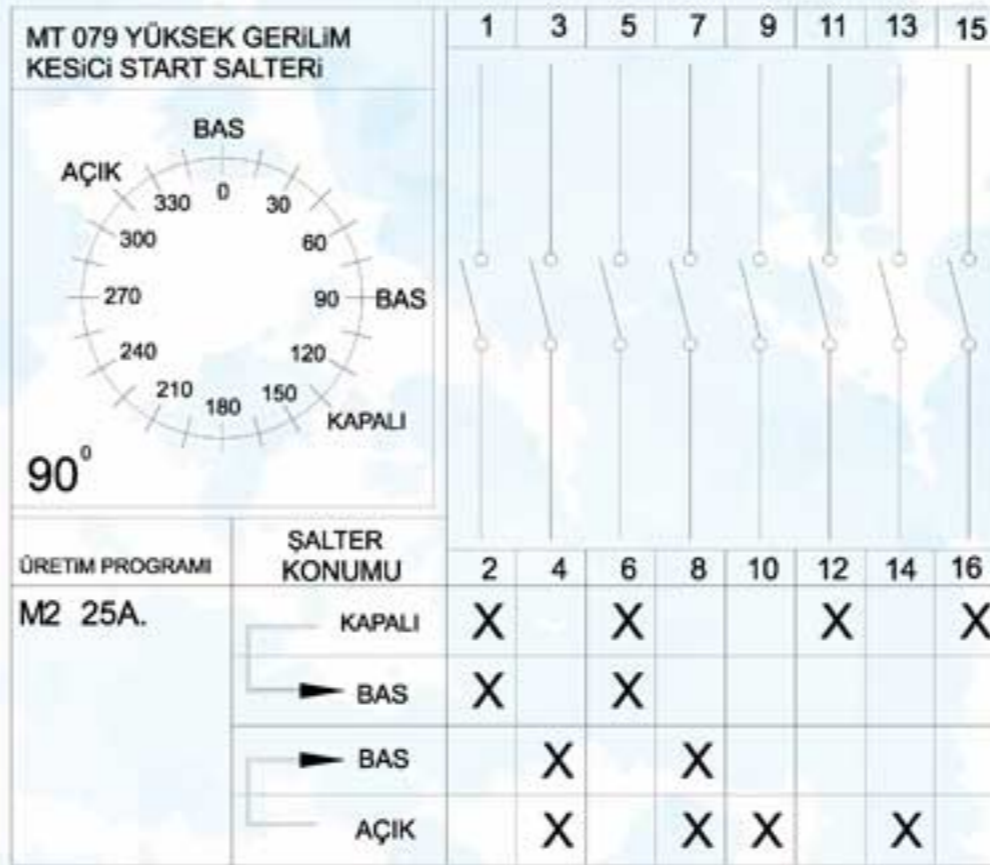

Anma akımı Rated current	Boyut Size	Kutu Ebatları/Box Sizes W x L x H (mm)
25 A	M 2	78x190x70

MT028 2 Fazlı Kutup Değiştirici Atkılı Şalter
2 Poles Jumper (Changeover) Switch

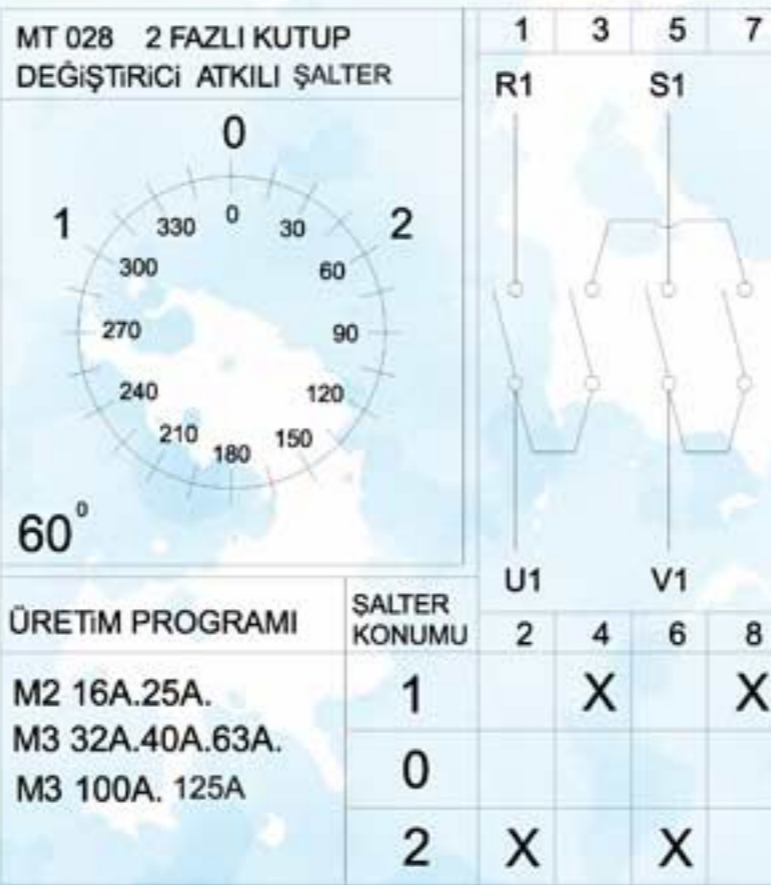
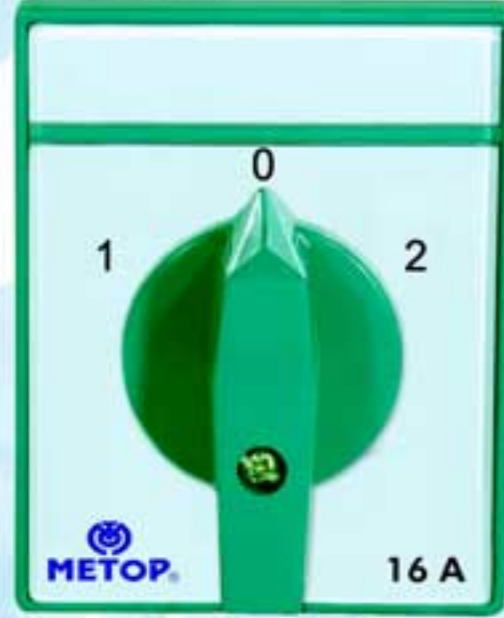

Anma akımı Rated current	Boyut Size	Kutu Ebatları/Box Sizes W x L x H (mm)
10 A	M 1	47x57x76
16 A	M 2	63x78x90
25 A	M 2	63x78x90
32 A	M 3	119x92x112
40 A	M 3	119x92x112
63 A	M 3	119x92x112
100 A	M 3	153x104x109
125 A	M 3	153x104x109

MT056 6 Fazlı Kutup Değiştirici Atkılı Şalter
6-Poles Jumper Changeover Switch

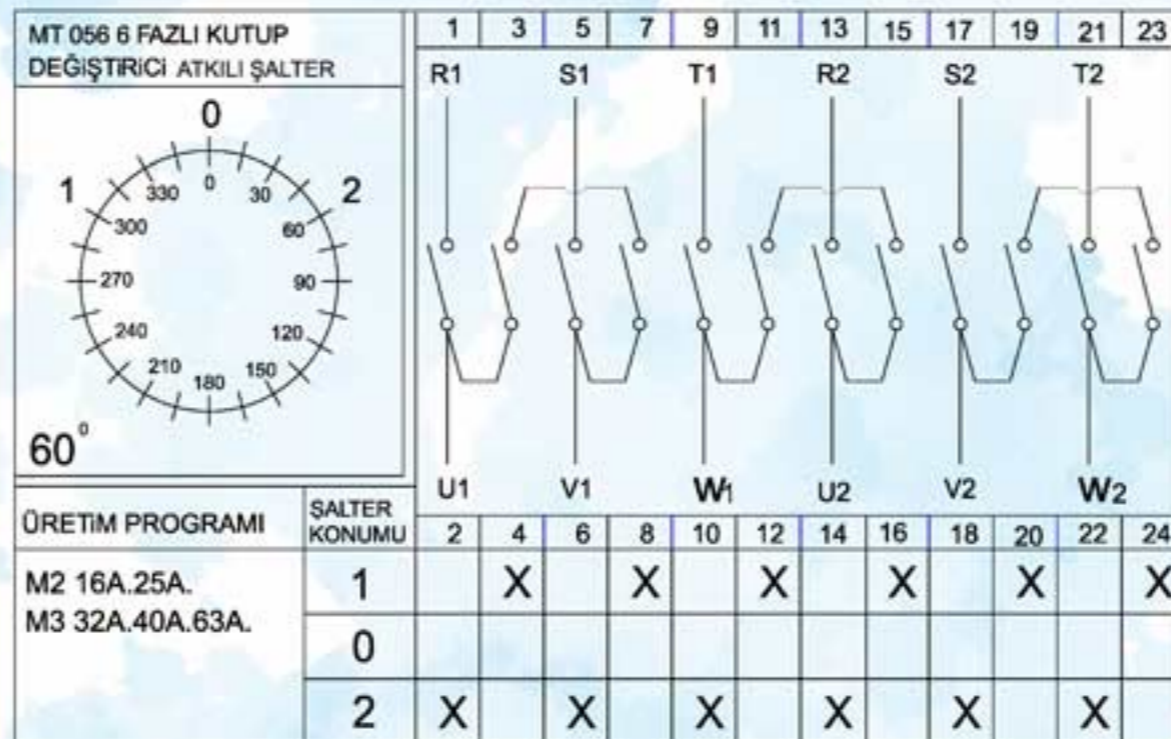

Anma akımı Rated current	Boyut Size	Kutu Ebatları/Box Sizes W x L x H (mm)
16 A	M 2	185x78x68
25 A	M 2	185x78x68
32 A	M 3	210x112x112
40 A	M 3	210x112x112
63 A	M 3	210x112x112

MT1094 2 Açık 2 Kapalı Şalter
2-On 2 Off Switch

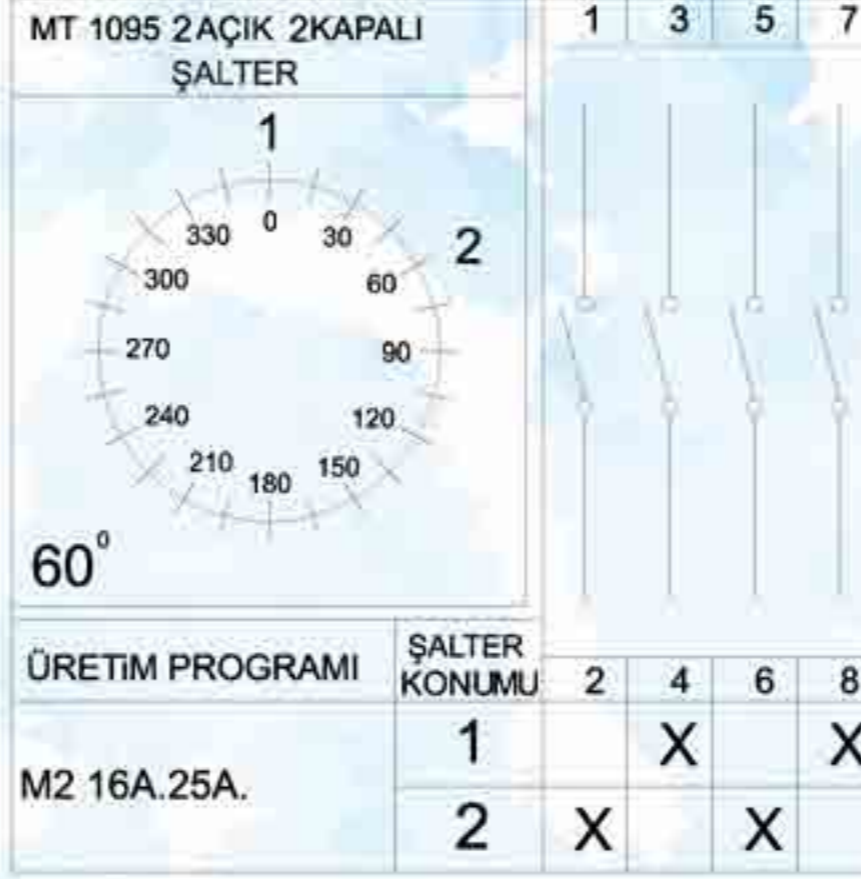

Anma akımı Rated current	Boyut Size	Kutu Ebatları/Box Sizes W x L x H (mm)
16A	M2	63x78x90
25A	M2	63x78x90

MT1095 4 Açık 4 Kapalı Şalter
4 On 4 Off Switch

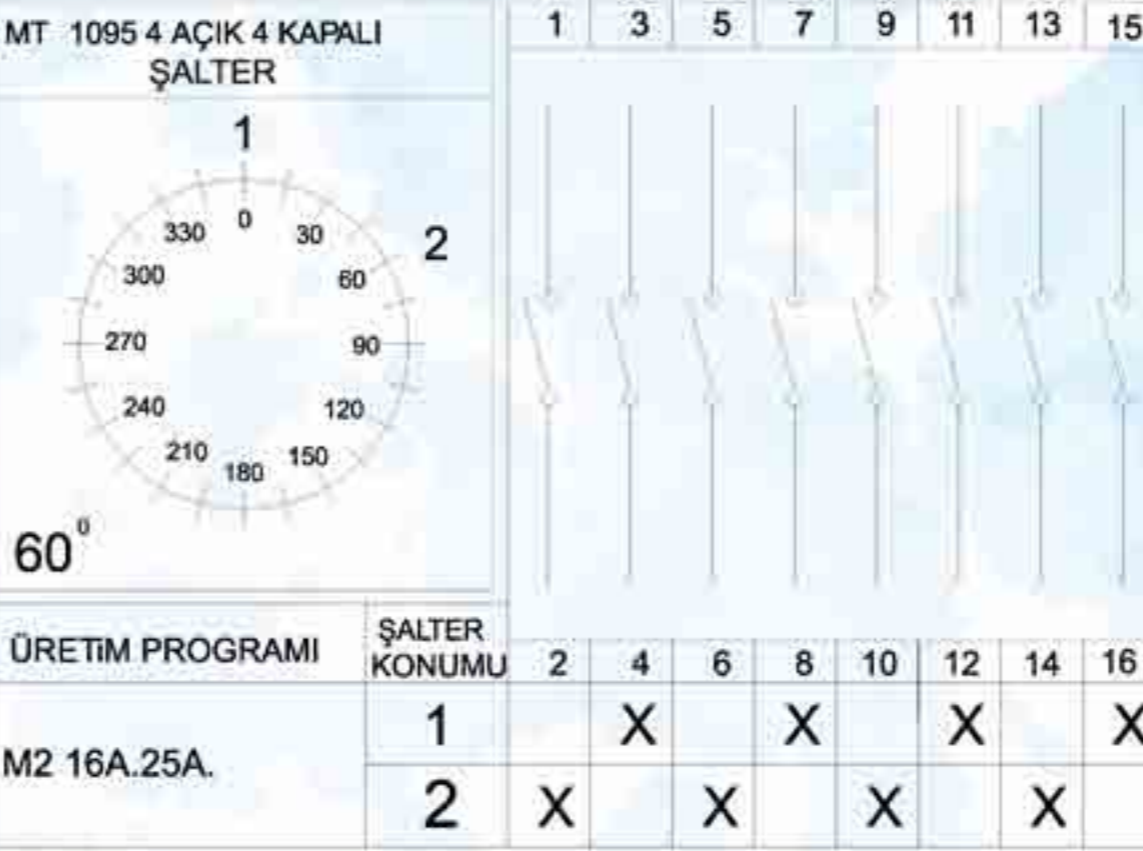

Anma akımı Rated current	Boyut Size	Kutu Ebatları/Box Sizes W x L x H (mm)
16A	M2	126x98x68
25A	M2	126x98x68

MT029 3 Fazlı Kutup Değiştirici
(Aç Kapa İleveli)
MT019 3-Pole Changeover Switch
(With On Off)

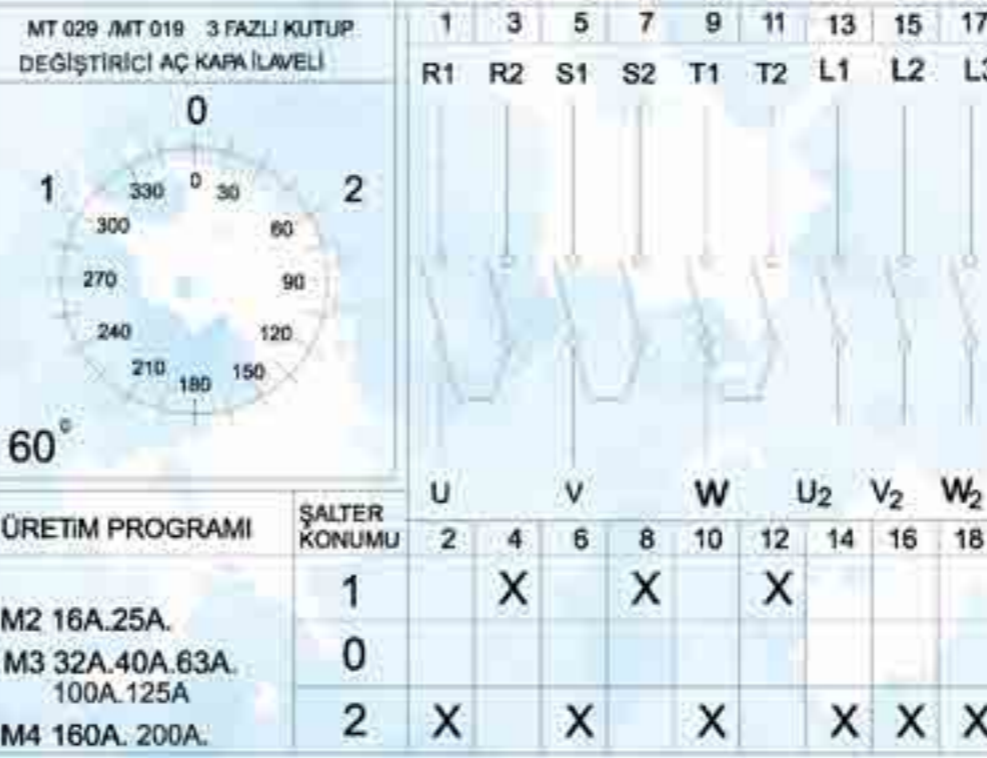
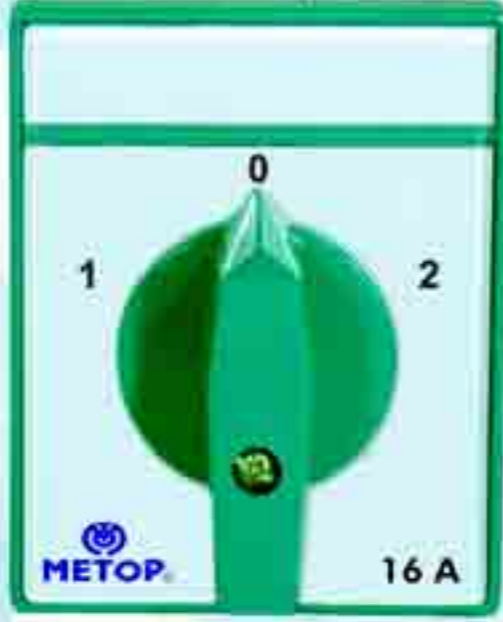

Anma akımı Rated current	Boyut Size	Kutu Ebatları/Box Sizes W x L x H (mm)
10 A	M 1	47x57x76
16 A	M 2	63x78x90
25 A	M 2	63x78x90
32 A	M 3	119x92x112
40 A	M 3	119x92x112
63 A	M 3	119x92x112
100 A	M 3	134x92x112
125 A	M 3	153x104x109
160 A	M 4	185x110x112
200 A	M 4	211x108x112

PANOYA MONTAJ ŞEKLİ
ASSEMBLING

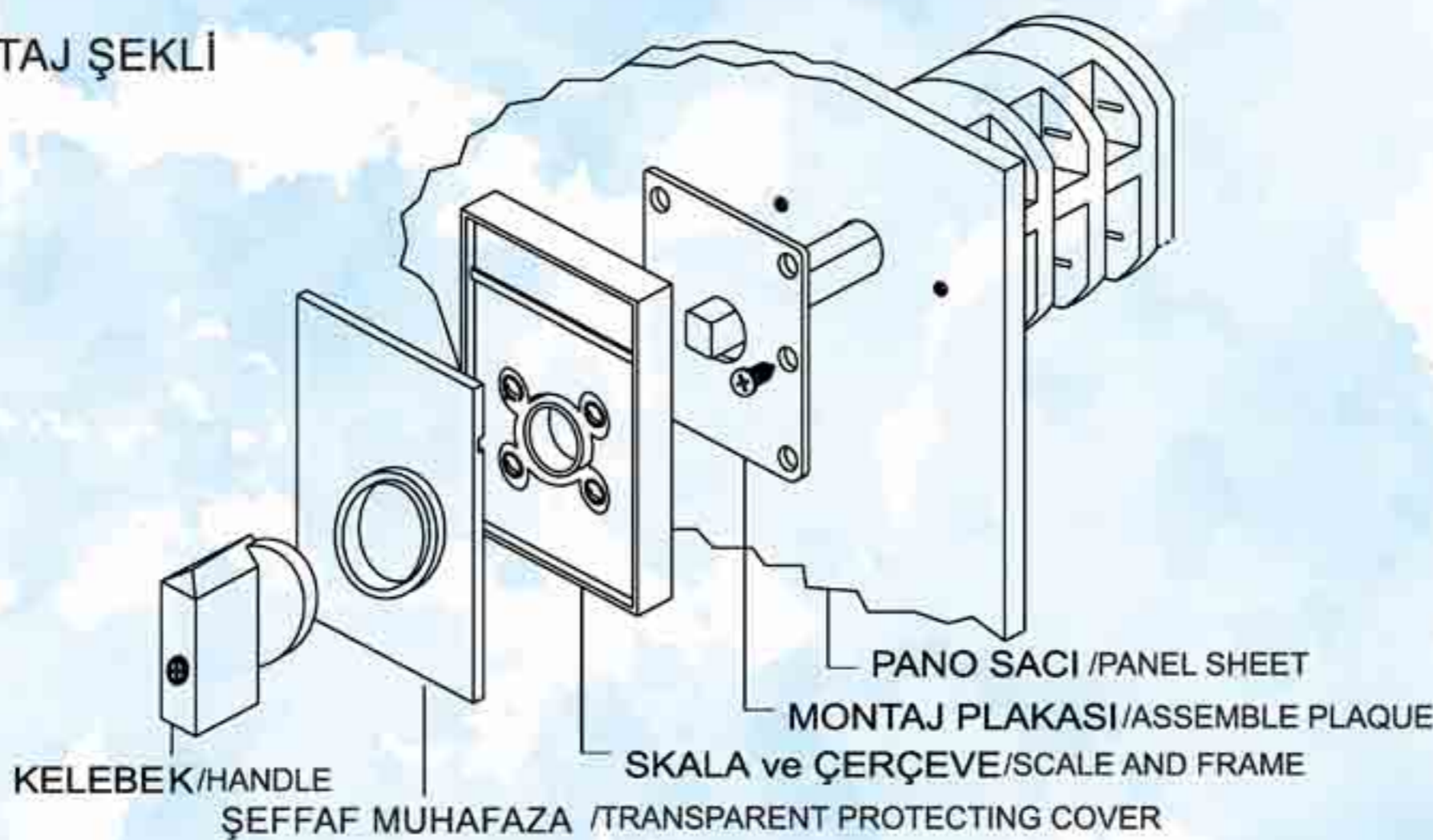

MT 059 16-25 A.

Plastik Aç-Kapa Şalter Kutusu
Plastic On-Off Switch Box



Mt 059 10 A

Plastik Aç-Kapa Şalter Kutusu
Plastic On-Off Switch Box



MT 058 32-40-63 A.

Aç/Kapa-Enversör-Kutup Değ.
Yıldız üçgen Şalter Kutusu
On-Off Reversing Changeover
Star Delta Plastic Switch Box



MT 060 16-25 A.

Plastik Enversör Şalter Kutusu
Plastic Reversing Switch Box



MT 072 25 A.

Üç Fazlı Aç Kapa
Plastik Kutulu
Three Pole On-Off
Plastic Box



MT 075 25 A.

Yıldız Üçgen Plastik Kutulu
Star Delta Plastic Box



MT 073 25 A.

3 Fazlı Enversör Plastik Kutulu
3 Pole Reversing Plastic Box



MT 074 25 A.

3 Fazlı Kutup Değiştirici
Plastik Kutulu
3 Pole Changeover
Plastic Switch Box



PAKET ŞALTER BOYUT ÖLÇÜLERİ/ROTARY CAM SWITCH SIZES

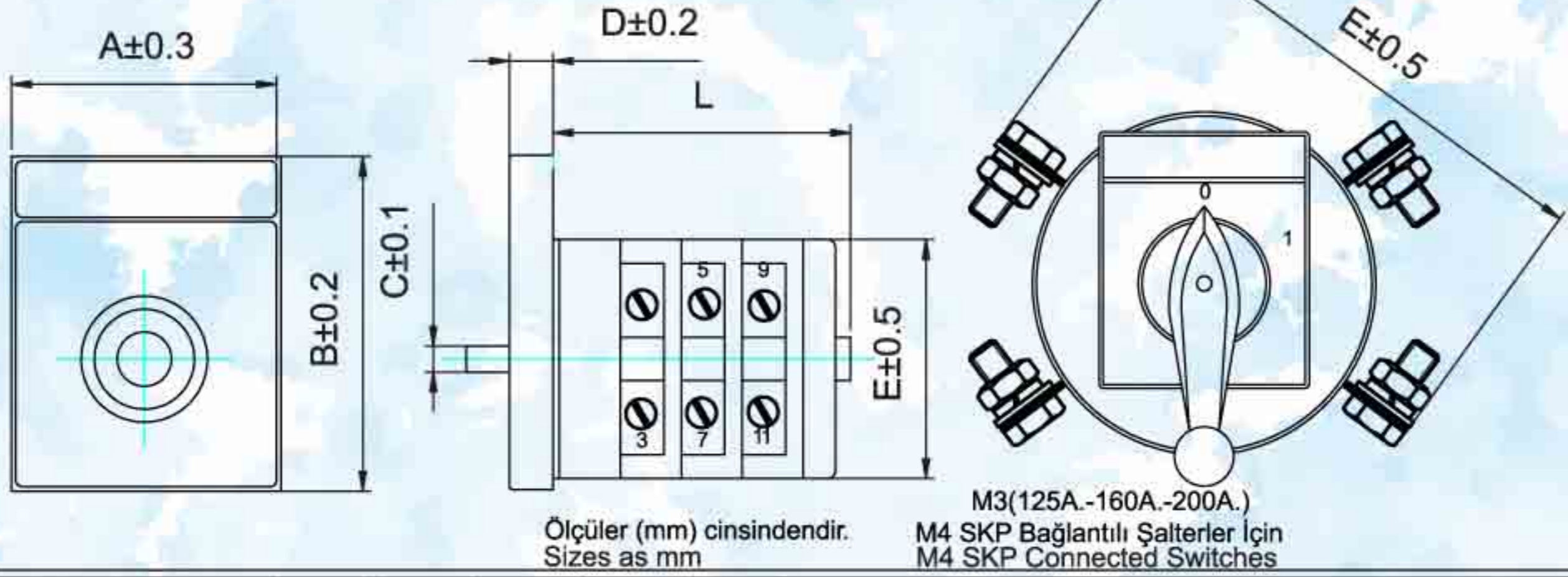

PAKET ŞALTER ROTARY CAM SWITCH	ANMA AKIMI RATED CURRENT	A	B	C	D	E
						Ø
M1	10 A.	44.5	56.7	4	8	40
M2	16-25 A.	61.8	76.7	6	8.5	54.3
M3	32-40 A.	85	104	8	9	80.8
	63 A.	85	104	8	9	80.8
	100 A.	85	104	8	9	80.8
	125 A.	85	104	8	9	125
	160 A.	85	104	8	9	125
M4	200A.	85	104	8	9	125
	100 A.	85	104	10	9	210
	125 A.	85	104	10	9	210
	160 A.	85	104	10	9	210
	200A.	85	104	10	9	210

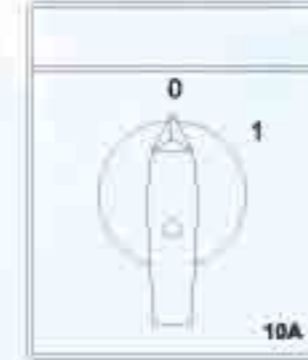

M1 ŞALTER

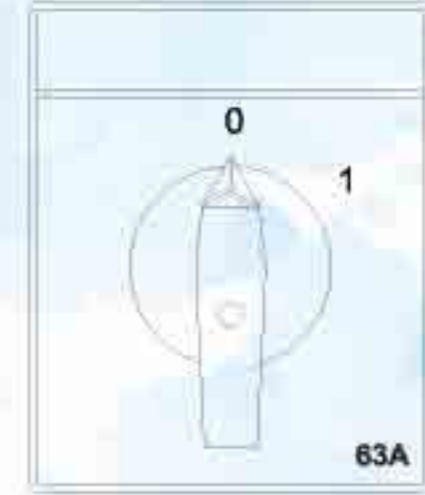

M3 ŞALTER

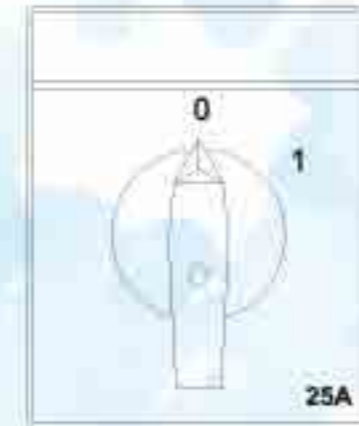

M2 ŞALTER

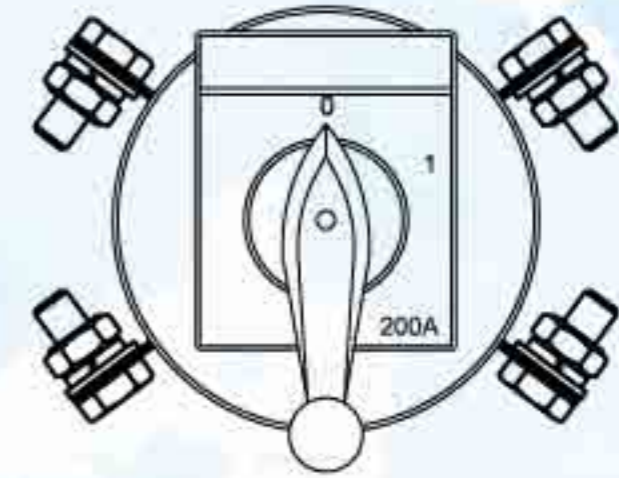

M4 ŞALTER

PLASTİK ŞALTER KUTULARI BOYUT ÖLÇÜLERİ
PLASTIC CAM SWITCH BOX SIZES

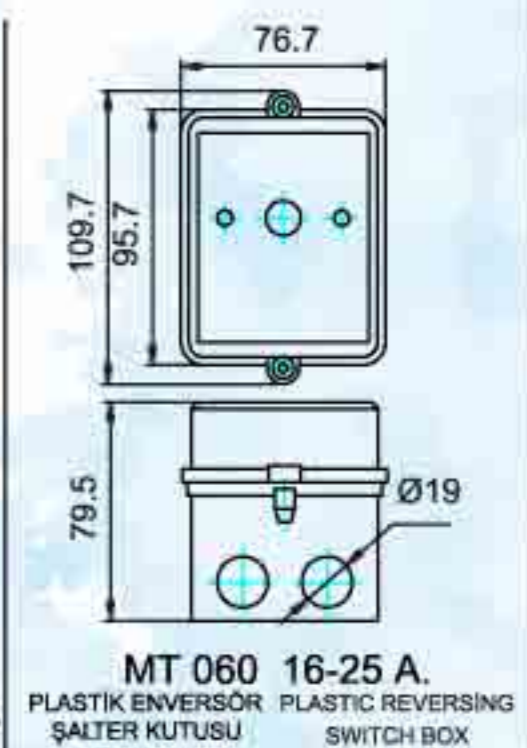
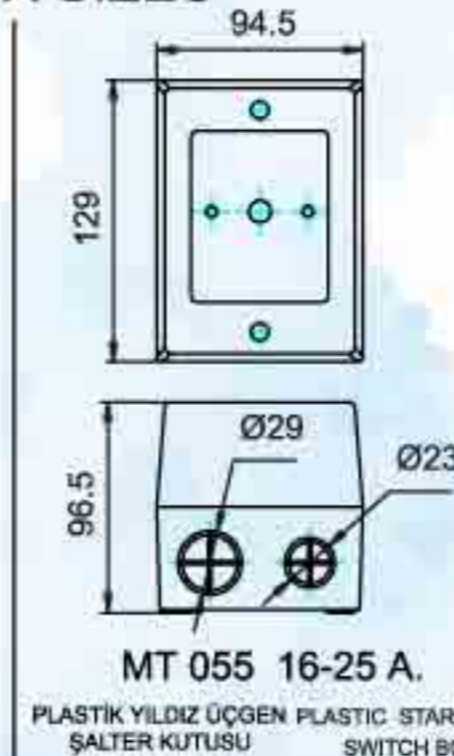
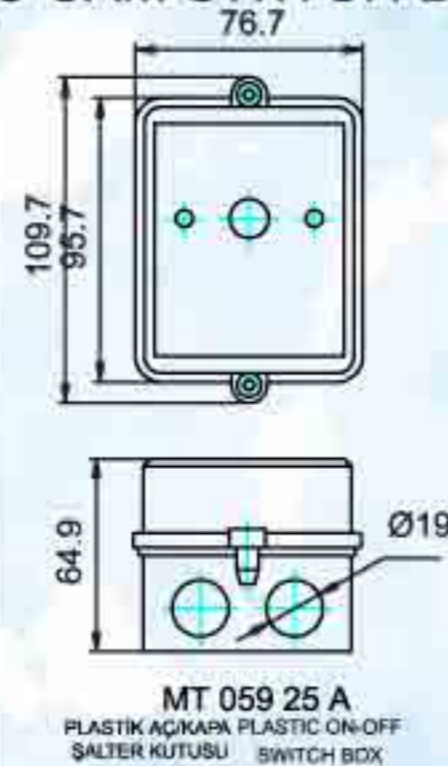
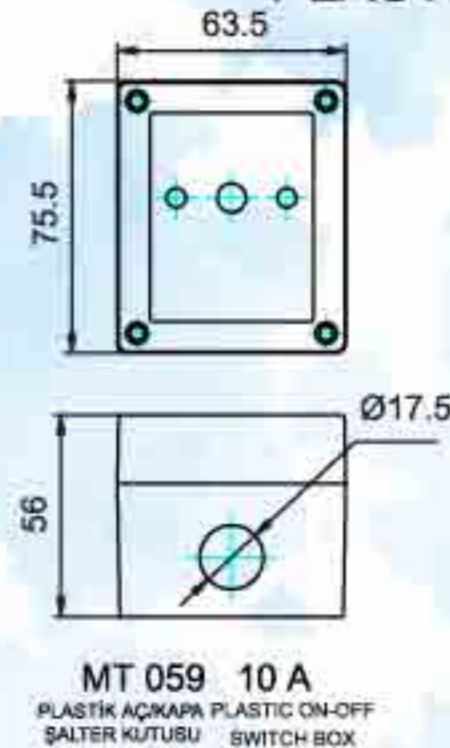
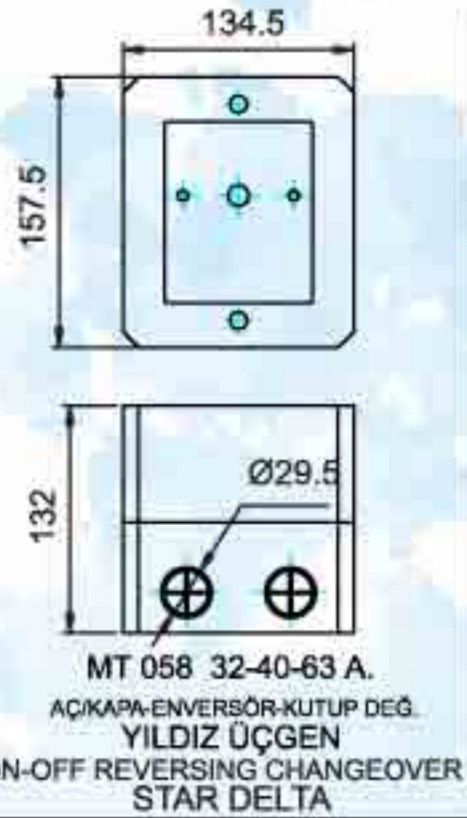

PAKET ŞALTERLERİN UZUNLUK ÖLÇÜLERİ TİP VE MİLİMETRİK(L) ÖLÇÜLERİ
TYPE AND LENGTH SIZES (MM) OF ROTARY CAM SWITCHES

Sıra	Kod	Cinsi	10 A	16 A	25 A	32/40 A	63 A	100 A	125 A	160 A	200 A
1	MT 015	1 Fazlı aç kapa şalter	M1-33.9	M2-39	M2-39	M2-53.1	M3-53.1	M3-53.1	M3-53.1	M3-73.2	M3-73.2
2	MT 017	2 Fazlı aç kapa şalter	M1-33.9	M2-39	M2-39	M2-53.1	M3-53.1	M3-53.1	M3-73.2	M3-73.2	M3-113.4
3	MT 019	3 Fazlı aç kapa şalter	M1-46.4	M2-53.6	M2-53.6	M2-73.2	M3-73.2	M3-73.2	M3-93.3	M3-113.4	M3-153.6
4	MT 082	Emniyet şalteri(kilitlenebilir)sarı-kırmızı skala					M3-73.2	M3-73.2	M3-93.3	M3-113.4	M3-153.6
5	MT 020	3 Fazlı nötrlü aç kapa şalter	M1-46.4	M2-53.6	M2-53.6	M2-73.2	M3-73.2	M3-73.2	M3-113.4	M3-113.4	M3-193.8
6	MT 021	3 Fazlı enversör sağ-sol şalter (1-0-2)	M1-58.9	M2-68.2	M2-68.2	M2-93.3	M3-93.3	M3-93.3	M3-153.6	M3-153.6	
7	MT 080	1 Fazlı enversör şalter (1-0-2)(doğru akım)	M1-46.4	M2-53.6	M2-53.6	M2-73.2	M3-73.2	M3-73.2	M3-113.4	M3-113.4	
8	MT 081	1 Fazlı enversör şalter (yard.Sar.Mot.)	M1-58.9	M2-68.2	M2-68.2	M2-93.3					
9	MT 022	Voltmetre komütatörü 3 pozlu		M2-53.6	M2-53.6	M2-73.2					
10	MT 050	Voltmetre komütatörü 4 pozlu		M2-68.2	M2-68.2	M2-93.3					
11	MT 1084	Voltmetre komütatörü 6 pozlu daimi dönen	M1-58.9	M2-68.2	M2-68.2	M2-93.3					
12	MT 063	Ampemetre komütatörü 0-r-s-t		M2-68.2	M2-68.2	M2-93.3					
13	MT 023	1 Fazlı 2 kademeli şalter	M1-33.9	M2-39	M2-39	M2-53.1	M3-53.1	M3-53.1	M3-73.2		
14	MT 024	1 Fazlı 3 kademeli şalter	M1-46.4	M2-53.6	M2-53.6	M2-73.2	M3-73.2	M3-73.2	M3-113.4	M3-113.4	M4-166
15	MT 025	1 Fazlı 4 kademeli şalter	M1-58.9	M2-68.2	M2-68.2	M2-93.3	M3-93.3	M3-93.3	M3-153.6	M3-153.6	M4-230
16	MT 026	1 Fazlı 5 kademeli şalter	M1-58.9	M2-68.2	M2-68.2	M2-93.3	M3-93.3	M3-93.3	M3-153.6	M3-153.6	M4-230
17	MT 061	1 Fazlı 6 kademeli şalter		M2-82.8	M2-82.8	M2-113.4	M3-113.4	M3-113.4	M3-153.6	M3-153.6	M4-294
18	MT 062	1 Fazlı 7 kademeli şalter		M2-82.8	M2-82.8	M2-113.4	M3-113.4	M3-113.4	M4-166	M4-166	M4-294
19	MT 066	1 Fazlı 8 kademeli şalter		M2-112	M2-112	M2-153.6	M3-153.6	M3-153.6	M3-153.6		
20	MT 067	1 Fazlı 9 kademeli şalter		M2-112	M2-112	M2-153.6	M3-153.6	M3-153.6	M3-153.6		
21	MT 068	1 Fazlı 10 kademeli şalter		M2-112	M2-112	M2-153.6	M3-153.6	M3-153.6	M3-153.6		
22	MT 027	1 Fazlı kutup değiştirici şalter 1-0-2	M1-33.9	M2-39	M2-39	M2-53.1	M3-53.1	M3-53.1	M3-73.2	M3-73.2	M4-102
23	MT 028	2 Fazlı kutup değiştirici şalter 1-0-2	M1-46.4	M2-53.6	M2-53.6	M2-73.2	M3-73.2	M3-73.2	M3-113.4	M3-113.4	M4-166
24	MT 029	3 Fazlı kutup değiştirici (jeneratör) şalteri	M1-58.9	M2-68.2	M2-68.2	M2-93.3	M3-93.3	M3-93.3	M3-153.6	M3-153.6	M4-230
25	MT 056	6 Fazlı kutup değiştirici şalter		M2-112	M2-112	M2-153.6	M3-153.6	M3-153.6	M3-153.6	M3-153.6	
26	MT 057	4 Fazlı kutup değiştirici nötrlü şalter		M2-82.8	M2-82.8	M2-113.4	M3-113.4	M3-113.4	M3-193.8	M3-193.8	M4-294
27	MT 054	Çift devirli motor şalteri (dahlender) 1-0-2		M2-82.8	M2-82.8	M2-113.4	M3-113.4	M3-113.4			
28	MT 1197	Çift devirli motor şalteri (dahlender) 0-1-2		M2-82.8	M2-82.8	M2-113.4	M3-113.4	M3-113.4			
29	MT 031	Yıldız üçgen şalter		M2-82.8	M2-82.8	M2-113.4	M3-113.4	M3-113.4	M3-166		M4-294
30	MT 032	1 Fazlı 2 kademeli seçici (toplama) şalter	M1-33.9	M2-39	M2-39	M2-53.1	M3-53.1	M3-53.1	M3-73.2		
31	MT 033	1 Fazlı 3 kademeli seçici (toplama) şalter	M1-58.9	M2-68.2	M2-68.2	M2-93.3	M3-93.3	M3-93.3	M3-153.6		
32	MT 034	1 Fazlı 4 kademeli seçici (toplama) şalter	M1-71.4	M2-82.8	M2-82.8	M2-113.4	M3-113.4	M3-113.4	M3-193.8		
33	MT 084	1 Fazlı 3 kademeli şebekeli şalter		M2-68.2	M2-68.2	M2-93.3	M3-93.3	M3-93.3	M3-153.6	M4-230	M4-230
34	MT 036	1 Fazlı 5 kademeli şebekeli şalter		M2-82.8	M2-82.8	M2-113.4	M3-113.4	M3-113.4	M3-193.8	M4-294	M4-294
35	MT 064	1 Fazlı 6 kademeli şebekeli şalter		M2-97.4	M2-97.4	M2-113.5	M3-133.5	M3-133.5	M4-198	M4-198	
36	MT 065	1 Fazlı 7 kademeli şebekeli şalter		M2-97.4	M2-97.4	M2-113.5	M3-133.5	M3-133.5	M4-198	M4-198	
37	MT 037	Daimi dönen 1 fazlı şalter 0-1	M1-33.9	M2-39	M2-39	M2-53.1					
38	MT 038	Daimi dönen 2 fazlı şalter 0-1	M1-33.9	M2-39	M2-39	M2-53.1					
39	MT 039	Daimi dönen 3 fazlı şalter 0-1	M1-46.4	M2-53.6	M2-53.6	M2-73.2					
40	MT 049	3 Fazlı 2 kademeli şalter	M1-58.9	M2-68.2	M2-68.2	M2-93.3	M3-93.3	M3-93.3	M3-153.6	M3-153.6	M4-230
41	MT 051	3 Fazlı 3 kademeli şalter		M2-112	M2-112	M2-153.6	M3-153.6	M3-153.6	M4-230		
42	MT 052	3 Fazlı 4 kademeli şalter		M2-155.8	M2-155.8	M2-213.9	M3-213.9	M3-213.9	M4-326		
43	MT 053	3 Fazlı 5 kademeli şalter		M2-155.8	M2-155.8	M2-213.9	M3-213.9	M3-213.9	M4-326		
44	MT 011	3 Fazlı 6 kademeli şalter		M2-392	M2-392	M2-274.2	M3-273.2	M3-273.2	M4-422		
45	MT 012	3 Fazlı 7 kademeli şalter		M2-392	M2-392	M2-274.2	M3-273.2	M3-273.2			
46	MT 013	3 Fazlı 8 kademeli şalter		M2-392	M2-392	M2-274.2	M3-273.2	M3-273.2			
47	MT 1073	Gazaltı kaynak makinası şalter 7 kademeli			M2-97.4	M2-113.5					
48	MT 1074	Gazaltı kaynak makinası şalter 3 kademeli			M2-112	M2-153.6	M3-153.6				
49	MT 1173	Gazaltı kaynak makinası şalter 10 kademeli		M2-112	M2-112	M2-153.6	M3-153.6				
54	MT 079	Yüksek gerilim kesici start şalteri			M2-82.8	M2-113.4					
55	MT 028	2 Fazlı kutup değiştirici atkılı şalter	M1-46.4	M2-53.6	M2-53.6	M2-73.2	M3-73.2	M3-73.2	M3-113.4	M3-113.4	M4-166
56	MT 056	6 Fazlı kutup değiştirici atkılı şalter		M2-112	M2-112	M2-153.6	M3-153.6	M3-153.6	M3-153.6	M3-153.6	
57	MT 1094	2 Açık 2 kapalı özel şalter		M2-53.6							
58	MT 1095	4 Açık 4 kapalı özel şalter		M2-82.8							
59	MT029/MT019	3 Fazlı kutup değiştirici aç kapa ilaveli şalter		M2-97.4	M2-97.4	M2-113.5	M3-133.5	M3-133.5	M3-53.10	M3-234	M4-358

METOP ELEKTRİK SAN.TİC.LTD.ŞTİ ÖZEL ŞALTER İSTEK FORMU

istenilen özelliğe ait bilgileri forma işledikten sonra firmamıza iletiniz. Teknik nedenlerden dolayı istenilen kontak kombinasyonlarına uyum sağlanamayabilir. Tel:0216 311 46 95 Fax: 311 46 99

TARİH:

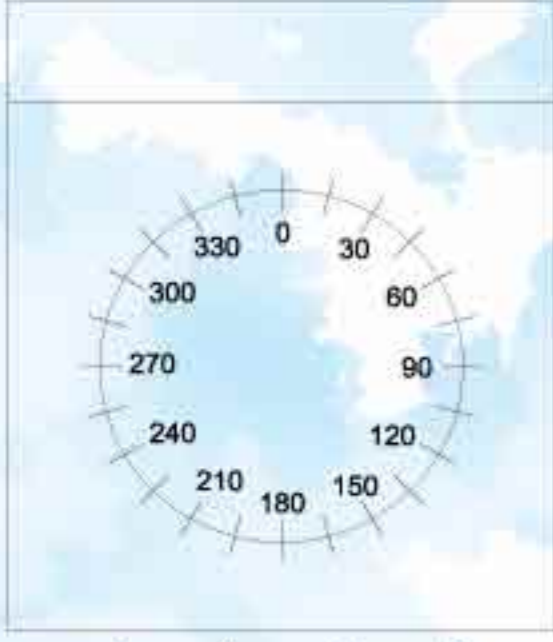

30° 45° 60° 90°

1	3	5	7	9	11	13	15	17	19	21	23	25	27	29	31	33	35	37	39	41	43	45	47
---	---	---	---	---	----	----	----	----	----	----	----	----	----	----	----	----	----	----	----	----	----	----	----



KÖPRÜLEME DURUMU

ŞALTER KONUMLARI

2	4	6	8	10	12	14	16	18	20	22	24	26	28	30	32	34	36	38	40	42	44	46	48
---	---	---	---	----	----	----	----	----	----	----	----	----	----	----	----	----	----	----	----	----	----	----	----

AÇIKLAMA:

FİRMA ADI:

TEL:
FAX:

ADET:

ÖRNEK FORM DOLDURMA

MT 026 1 FAZLI
5 KADEME ŞALTER

1	3	5	7	9	11
1	4	2	5	3	

KÖPRÜLEME DURUMU	ŞALTER KONUMU	2	4	6	8	10	12
0							
1	X						
2			X				
3					X		
4		X					
5				X			

ETİKET

⊕3	⊕1	⊕2	⊕4
⊕7	⊕5	⊕6	⊕8
⊕11	⊕9	⊕10	⊕12
⊕15	⊕13	⊕14	⊕16
⊕19	⊕17	⊕18	⊕20
⊕23	⊕21	⊕22	⊕24
⊕27	⊕25	⊕26	⊕28
⊕31	⊕29	⊕30	⊕32
⊕35	⊕33	⊕34	⊕36
⊕39	⊕37	⊕38	⊕42
⊕43	⊕41	⊕42	⊕46
⊕47	⊕45	⊕46	⊕48

Şalterin kontak numaralama durumu

Teknik Destek Hattı : 0 216 311 4695 (Dahili : 5)
Technical Call Center : +90 216 311 4695 (Internal : 5)

TÜRK STANDARDLARI ENSTİTÜSÜ
İMALÂTA YETERLİLİK BELGESİ

BELGE NUMARASI : 34148.1/6327
VERİLİŞ TARİHİ : 19.04.2007

FİRMANIN ADI VE ADRESİ : METOP ELEKTRİK SAN. VE TİC. LTD. ŞTİ.
BAKLALI MAH. YAN. YOL ÜZERİ 81470 SAMANDIRA / İSTANBUL

ÖRETİM YERİ ADRESİ : BAKLALI MAH. YAN. YOL ÜZERİ 81470
SAMANDIRA / İSTANBUL

SANAYİ SİCİL NUMARASI : TİCARET SİCİL NUMARASI :
184752/132266

132 SAYILI KANUN GEREĞİNCE VE TÜRK STANDARDLARI ENSTİTÜSÜ MEVZUATI
UYARINCA YAPILAN İNCELEME SONUCUNDA BELGİLENEN MADDE VE MAMULLERİN İMALATI
ADRESİNİ VERİLEN KURULUŞ YETERLİLİK BELGESİNE İŞİ BU BELGE YARARINDIR.

"METOP" MARKALI
TS EN 60947-3/ENSA 1999 "ALÇAK GERİLİM ANAHTARLAMA DÜZENİ
VE KONTROL DÜZENİ BÖLÜM 3: ANAHTARLAR AYIRICILAR,
ANAHTARLI AYIRICILAR VE BİRLEŞTİRİLMİŞ SİGORTALAMA BİRİMLERİ"

- SABİT TESİSLİ, KESME ORTAMI HAVA OLAN ELLE ÇALIŞTIRMALI,
DÖNER MEKANİZMALI, ANAHTARLAR (PAKO ŞALTERLER)
- ANMA AKIMI: 10 AMPERDEN 125 AMPERE KADAR (125 Amper dahil)
- TİP VE KULLANMA KATEGORİLERİ: MT 019-10A, MT 019-16A,
MT 019-125A, AC-21A, AC-21B, AC-22A, AC-23A, AC-3
- KORUMA SİNİFLİ İP 00 KORUMALI
- KUTUP SAYISI 1 VE 3 KUTUPLU
- BEYAN YALITIM GERİLİMİ: 660V
- ANMA GERİLİMİ: 400V
- KES. DEVRE DAY. AKIMESKA

19.04.2005

BU BELGE EN SON YAZI TARİHİNDE İTİBAREN 1 YIL GEÇERLİDİR. YILLIK YAZI TARİHİNDE BELGE GEÇERLİDİR.
BU BELGE EN SON YAZI TARİHİNDE İTİBAREN 1 YIL GEÇERLİDİR. YILLIK YAZI TARİHİNDE BELGE GEÇERLİDİR.
Not: Bu belge zayıf ulanmamakla birlikte 23.04.2007 tarihinde yeniden gözden geçirilmiştir.

TSE
TÜRK STANDARDLARI ENSTİTÜSÜ
TÜRK STANDARDLARINA UYGUNLUK BELGESİ

BELGE NUMARASI : 34148.1/6327
VERİLİŞ TARİHİ : 19 / 04 / 2007

FİRMANIN ADI VE ADRESİ : METOP ELEKTRİK SAN. VE TİC. LTD. ŞTİ.
BAKLALI MAH. YAN. YOL ÜZERİ 81470 SAMANDIRA / İSTANBUL

ÖRETİM YERİ ADRESİ : BAKLALI MAH. YAN. YOL ÜZERİ 81470 SAMANDIRA / İSTANBUL

İLGİLİ TÜRK STANDARDI : TS EN 60947-3/ENSA 1999 "ALÇAK GERİLİM
ANAHTARLAMA DÜZENİ VE KONTROL DÜZENİ BÖLÜM 3: ANAHTARLAR
AYIRICILAR, ANAHTARLI AYIRICILAR VE BİRLEŞTİRİLMİŞ SİGORTALAMA BİRİMLERİ"

TSE MARKASI KULLANILMASINA İZİN VERİLEN MAMULÜN
MARKASI, ADI, SINIFI, TİPİ, TÜRÜ VE ÖZELLİKLERİ

"METOP" MARKALI

- SABİT TESİSLİ, KESME ORTAMI HAVA OLAN ELLE
ÇALIŞTIRMALI, DÖNER MEKANİZMALI,
ANAHTARLAR (PAKO ŞALTERLER)
- ANMA AKIMI: 10 AMPERDEN 125 AMPERE KADAR (125
Amper dahil)
- TİP VE KULLANMA KATEGORİLERİ: MT 019-10A, MT 019-
16A, MT 019-125A, AC-21A, AC-21B, AC-22A, AC-23A, AC-3
- KORUMA SİNİFLİ İP 00 KORUMALI
- KUTUP SAYISI 1 VE 3 KUTUPLU
- BEYAN YALITIM GERİLİMİ: 660V
- ANMA GERİLİMİ: 400V
- KES. DEVRE DAY. AKIMESKA

19.04.2005

BU BELGE EN SON YAZI TARİHİNDE İTİBAREN 1 YIL GEÇERLİDİR. YILLIK YAZI TARİHİNDE BELGE GEÇERLİDİR.
BU BELGE EN SON YAZI TARİHİNDE İTİBAREN 1 YIL GEÇERLİDİR. YILLIK YAZI TARİHİNDE BELGE GEÇERLİDİR.
Not: Bu belge zayıf ulanmamakla birlikte 23.04.2007 tarihinde yeniden gözden geçirilmiştir.

RWTÜV
SERTİFİKA
TÜV Teknik Kontrol ve Belgelendirme A.Ş.
Sertifika Komisyonu

İşbu belge ile

METOP Elektrik Sanayi ve Ticaret Ltd. Şti.
Osman Gazî Mah., Battalî Gazî Cad., No 35, Samandıra, Kartal
İstanbul / Türkiye

ünvanlı kuruluşun, aşağıda belirtilen geçerlilik alanında

NH sigortaları, paket şalterler, kompakt şalterler,
kontakörler ve bu ürünlerin aparatları ile genel şalterler,
elektrik malzemeleri tasarımı ve üretimi

bir kalite yönetim sistemini yürürlüğe koyduğunu
ve uygulamakta olduğunu, ilgili prosedür uyarınca
teyit eder.

TR 778 rapor sayılı bir teftik ile
TS EN ISO 9001:2000 ; EN ISO 9001:2000
şartlarının sağlanmış olduğu kanıtlanmıştır.

İşbu sertifika 03 Mayıs 2007
tarihine kadar geçerlidir.
Sertifika Tescil No: 1005605

Sertifika, tasarımcı ve üreticinin sorumluluğunda kalite kontrol sistemini düzenlemesi,
pazarında faaliyet göstermesi için geçerlidir.

19.04.2005

TÜV CERT
SERTİFİKA
RWTÜV Systems GmbH - Kalite Yönetimi Sistemleri
TÜV CERT Sertifikasyon Merkezi

İşbu belge ile

METOP Elektrik Sanayi ve Ticaret Ltd. Şti.
Osman Gazî Mah., Battalî Gazî Cad., No 35, Samandıra, Kartal
İstanbul / Türkiye

ünvanlı kuruluşun, aşağıda belirtilen geçerlilik alanında

NH sigortaları, paket şalterler, kompakt şalterler,
kontakörler ve bu ürünlerin aparatları ile genel şalterler,
elektrik malzemeleri tasarımı ve üretimi

bir kalite yönetim sistemini yürürlüğe koyduğunu
ve uygulamakta olduğunu, TÜV CERT prosedürü
uyarınca teyit eder.

2.5-0572/2004 rapor sayılı bir teftik ile
ISO 9001 : 2000 / EN ISO 9001 : 2000
şartlarının sağlanmış olduğu kanıtlanmıştır.

İşbu sertifika 03 Mayıs 2007
tarihine kadar geçerlidir.
Sertifika Tescil No: 04100 20040710

19.04.2005

RWTÜV
CERTIFICATE
The Certification Body of
TÜV Teknik Kontrol ve Belgelendirme A.Ş.
hereby certifies in accordance with relevant
procedure that

METOP Elektrik Sanayi ve Ticaret Ltd. Şti.
Osman Gazî Mah., Battalî Gazî Cad., No 35, Samandıra, Kartal
İstanbul / Turkey

has established and applies a quality system for

Design, production and sales of NH fuses and bases, rotary
cam switches, moulded case circuit breakers (MCCB),
contractors, general switches, electrical components

An audit was performed. Report No. TR 778
Proof has been furnished that the requirements according to
TS EN ISO 9001:2000 ; EN ISO 9001:2000
are fulfilled. The certificate is valid until 03 May 2007
Certificate Registration No. 1005605

The certificate remains valid until the above stated date and only if there is no
interrupted compliance with the requirements of the standard and certification agreement.

19.04.2005

TÜV CERT
CERTIFICATE
The TÜV CERT Certification Body
for QM-Systems of RWTÜV Systems GmbH
hereby certifies in accordance with TÜV CERT
procedure that

METOP Elektrik Sanayi ve Ticaret Ltd. Şti.
Osman Gazî Mah., Battalî Gazî Cad., No 35, Samandıra, Kartal
İstanbul / Turkey

has established and applies a quality system for

Design, production and sales of pipe fittings part made of glass
fibre reinforced polyester (GRP) for the automotive industry

An audit was performed. Report No. 2.5-0572/2004
Proof has been furnished that the requirements according to
ISO 9001 : 2000 / EN ISO 9001 : 2000
are fulfilled. The certificate is valid until 03 May 2007
Certificate Registration No. 04100 20040710

19.04.2005



METOP®

ELEKTRİK SANAYİ VE TİCARET LTD. ŞTİ

Samandıra Osmangazi Mah.
Battalgazi cad. No:35
Kartal-İstanbul/TURKEY
Tel: +90.216. 311 46 95
Fax: +90.216. 311 46 99
www.metopelektrik.com.tr
info@metopelektrik.com.tr

